

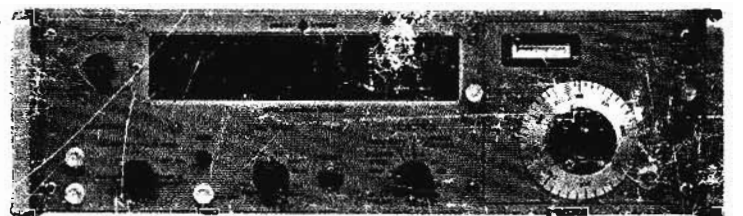

**ELECTRONIC
TEST
INSTRUMENTS**

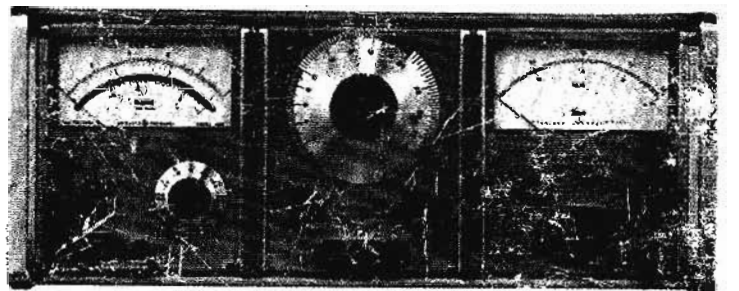
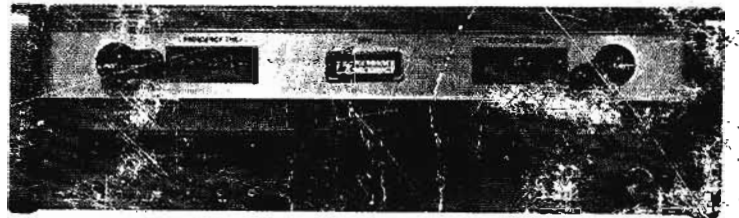
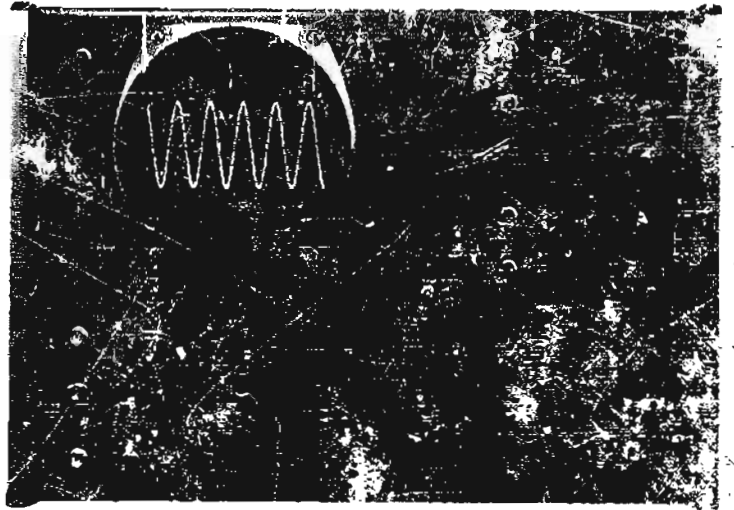

FOUR EASY WAYS TO USE THIS CATALOG

1. Check headings on opposite page for general type of instrument. Use convenient edge marks to find proper pages.
2. Turn to pages 1b through 5 for five pages of "Short Form Catalog" listing *hp* instruments by type or function (example—"Signal Generators 50 KC to 40 GC").
3. Find equipment by its model number in the numerical index, beginning on page 262 at back of this catalog (example—"400D Voltmeter").
4. Find equipment by its name or title, alphabetical index back of this catalog, pages 258-261 (example—"Digital Voltmeter").

Other Important Information

This catalog includes detailed information on all instruments available from Hewlett-Packard and Harrison Laboratories. Information is also provided on complete lines or selected instruments and systems manufactured by Hewlett-Packard divisions and affiliates. Ask your *hp* representative for information on new instruments introduced after catalog publication date.

PLACING YOUR ORDER OR RETURNING INSTRUMENTS.

Page 1a contains time-saving suggestions for ordering. Pages 20 and 21 have information on service and repairs.

DIVISIONS, AFFILIATES.

Page 8 contains a summary of equipment available from Hewlett-Packard divisions and affiliates, indexed on the opposite page. Pages 9 through 17 offer brief descriptions of specific instruments and systems manufactured by each member of the *hp* family. A special section on power supplies, pages 243 through 257, gives complete technical data on instruments available from Harrison Laboratories.

OTHER INFORMATION ON INSTRUMENTS.

In addition to data in this catalog, information about application and operation of *hp* equipment is found in *hp* Data Sheets, Application Notes and the Hewlett-Packard Journal, monthly technical periodical from the Research and Development laboratories. These publications are offered without charge; see page 22 for details.

COMMUNICATING WITH HEWLETT-PACKARD.

Mail: 1501 Page Mill Road,
Palo Alto, California, U. S. A.
Telephone: 326-7000, Area Code 415.
TWX: 415-492-9200.
Cable: HEWPACK.

COMMUNICATING WITH ENGINEER-SALESMAN.

Hewlett-Packard engineer-salesmen are located in most major manufacturing centers in the United States and Canada, and principal cities overseas. Names and complete addresses of Hewlett-Packard representatives and sales offices are listed inside the back cover of this catalog.

COMMUNICATING WITH HEWLETT-PACKARD S. A.

Mail: 54 Route des Acacias,
Geneva, Switzerland.
Telephone: (022) 42. 81. 50.
Telex: 2. 24. 86.
Cable: HEWPACKSA.

Instruments in this catalog are grouped by type or function. Each group is generally preceded by "Technical Data" pages which summarize the equipment offered in the group and discuss circuit theory and latest measuring techniques.

OSCILLOSCOPES — PULSE GENERATORS

<i>Oscilloscopes</i>	23
Low Frequency Scopes	24
High Frequency Scopes	27
Sampling Scopes	34
<i>Pulse Generators</i>	44
	56

AUDIO-VIDEO INSTRUMENTATION

<i>Oscillators and Audio Signal Generators</i>	63
<i>Wave and Distortion Analyzers</i>	64
<i>Voltmeters, Ohmmeters, Ammeters</i>	77
<i>Voltmeter Calibrators and Accessories</i>	84
<i>Amplifiers</i>	109
<i>Attenuators</i>	112
	118

FREQUENCY AND TIME MEASURING INSTRUMENTATION

<i>Solid State Electronic Counters</i>	119
<i>Vacuum Tube Electronic Counters</i>	123
<i>Digital Recorders</i>	134
<i>Frequency and Time Standards</i>	144
<i>Frequency Synthesizer</i>	152
	154

MICROWAVE INSTRUMENTATION

<i>Microwave Test Equipment Summaries</i>	162
S-Band	168
G, J-Bands	170
H, X-Bands	172
P-Band	174
K, R-Bands	176
M-Band	178
Coaxial Instrumentation	180
<i>Noise Figure Measurement Instruments</i>	182
<i>Power Measurement Instruments</i>	194
<i>TWT Amplifiers</i>	202
<i>Wavemeters</i>	204
<i>Signal Generators, Modulators</i>	205
<i>Sweep Oscillators</i>	228
<i>Impedance Measurement Instruments</i>	231

POWER SUPPLIES

242

ADDITIONAL PRODUCT LISTINGS

BOONTON RADIO COMPANY	9
DYMEC DIVISION	12
F. L. MOSELEY CO.	14
SANBORN COMPANY	16
	9

SUGGESTIONS FOR ORDERING

Order by Model Number

When you order, please specify the catalog model number and name of instrument desired. For example, "Model 400D Vacuum Tube Voltmeter." To prevent misunderstanding, include significant specifications and specific instructions in your order whenever you desire special options or special features such as special color, nonstandard power line voltage, etc.

Many Hewlett-Packard instruments are available in cabinets for bench use or with 19" panels for rack mounting. The letter "R" after the model number indicates a rack mounting instrument. For example, "400DR." Catalog listings indicate availability of cabinet or rack mounting arrangements. Please be sure your order indicates which you desire. With many instruments, bench and rack mount models are identical.

Where to Send Your Order

Your order should be made out to the Hewlett-Packard Company and sent to Hewlett-Packard, through your local ☉ representative (*see inside of back cover*). See additional information below if you are located outside the United States.

Local Technical Assistance

Technical assistance in selecting equipment and preparing orders is available without charge from engineering representatives at authorized ☉ sales offices in the United States and in principal areas throughout the world (*see inside back cover for names and addresses*.) In addition, a staff of qualified engineers is maintained at ☉ offices in Palo Alto, California, and Geneva, Switzerland, to supplement the services available from your local representatives.

Shipping Methods

Shipments to destinations within the United States and Western Europe are made directly from local factories or warehouses. Unless specifically requested otherwise, express or truck transportation is used, whichever is cheaper and most serviceable to you. Small items are sent via parcel post. If rapid delivery is needed, we will gladly ship by the more expensive methods of air freight, air express or air parcel post when specified on your order.

Additional Information For Customers Outside the United States

Where to Send Your Order

In many countries, your order can be placed directly on your local ☉ distributor or representative (*see inside back cover*). Alternatively, your order can be made out to Hewlett-Packard Company, (Hewlett-Packard S. A. if you are in Western Europe) and sent to the appropriate Hewlett-Packard office, either directly or through your local ☉ authorized sales offices.

If no ☉ representative or distributor has, as yet, been appointed for your area, your order should be placed directly on the Hewlett-Packard Co., 1501 Page Mill Road, Palo Alto, California, U. S. A.

Shipping Methods

Shipments to customers outside the United States or Western Europe are made from the appropriate ☉ facility by either surface or air, as requested. Sea shipments generally

Terms

U. S. terms are 30 days net. Unless credit has already been established, shipments will be made C.O.D., or on receipt of cash in advance. See additional information below if you are located outside the United States.

Quotations and Pro Forma Invoices

Upon request, quotations, or pro forma invoices, will be furnished to you by your local authorized ☉ sales office, the Hewlett-Packard Company or Hewlett-Packard S. A. Prices will be specified on an F.O.B. factory basis unless otherwise requested.

Repairs

An extensive service facility is maintained in Palo Alto, California, to repair and recalibrate any Hewlett-Packard instrument. In most cases repairs can also be made in the field, either by your own service technicians or by factory-trained personnel at one of the field repair facilities maintained by your local Hewlett-Packard representative or distributor (*see inside of back cover for locations and addresses*).

Field servicing of instruments is normally faster since transportation time to the factory is eliminated. If, however, you wish to return an instrument to the factory for repairs, recalibration, or for any other reason, please contact Customer Service, Hewlett-Packard Company, 395 Page Mill Road, Palo Alto, California, phone: 326-3950, before shipment for instructions. Please give model number, name, serial number, and as much other information as possible concerning the reason for return. Non-warranty repairs are made at the cost of labor and materials, plus a small service charge. See page 20 for information on warranty repairs.

Repair Parts

Repair parts are ordered in the same way as instruments. Please identify parts by the ☉ stock number shown in the instruction manual, and if possible, by the schematic diagram circuit reference number. Model number and serial number of the instrument, and original purchase date should also be given, if known. See page 20 for additional information.

require special export packaging at a nominal surcharge of \$5.00 per instrument.

Terms

Terms for orders from countries outside the United States which are placed on the Hewlett-Packard Company, or Hewlett-Packard S. A. are irrevocable letter of credit or cash in advance unless other terms have been arranged previously. Terms for orders placed on authorized Hewlett-Packard distributors are mutually determined between the customer and the distributor.

Quotations and Pro Forma Invoices

FAS, CIF, C & F, etc., quotations or pro forma invoices, as well as exportation assistance, are available on request from your local authorized ☉ sales office, the Hewlett-Packard Co., Palo Alto, California, or Hewlett-Packard S. A., Geneva, Switzerland.

Oscilloscopes - DC to 1000 MC

Model	Instrument	Features	Page
120B	450 kc general purpose oscilloscope	simple operation, dc to 450 kc	28
122A	200 kc dual trace oscilloscope	twin vertical amplifiers, dual trace viewing	29
130C	high sensitivity 500 kc oscilloscope	200 μ v/cm sensitivity, identical horizontal and vertical amplifiers	30, 31
140A	general purpose oscilloscope	plug-in versatility, including dual trace	32, 33
1400	plug-in series for 140A scope	amplifiers, time base, dual trace	32, 33
160B	militarized 15 mc oscilloscope	plug-in versatility, including dual trace	36, 37
162, 166	plug-in series for 160B, 170A scopes	vertical amplifiers, time base, time mark and sweep delay generators	36, 37
170A	militarized 30 mc oscilloscope	plug-in versatility, including dual trace	36, 37
175A	universal 50 mc oscilloscope	plug-in versatility, including dual, 4-trace	38-43
1750, 1780	plug-in series for 175A scope	vertical amplifiers, time base, time mark and sweep delay generators, display scanner	40-43
185B	1000 mc oscilloscope	sampling scope, 5" CRT, plug-in versatility	46-51
186A	switching time tester plug-in for 185B scope	permits measurements on transistors, diodes, etc.	48, 49
187B	dual-trace plug-in for 185B scope	10 mv/cm to 200 mv/cm	48
196A,B	oscilloscope cameras for all hp scopes	prints, transparencies on Polaroid® film	53

Oscillators - 0.008 CPS to 10 MC

Model	Instrument	Frequency Range	Output	Page
200AB	audio oscillator	20 cps to 40 kc	1 watt, 24.5 v	68, 69
200CD	wide-range oscillator	5 cps to 600 kc	160 mw or 10 v into 600 ohms; 20 v open circuit	68, 69
200J	interpolation oscillator	6 cps to 6 kc	160 mw or 10 v into 600 ohms; 20 v open circuit	72
200SR	wide-range oscillator	5 cps to 600 kc	3 v into 50 ohms	110
200T	telemetry oscillator	250 cps to 100 kc	160 mw or 10 v into 600 ohms; 20 v open circuit	72
201C	audio oscillator	20 cps to 20 kc	3 w or 42.5 v into 600 ohms	68, 69
202A	low frequency function generator	0.008 cps to 1200 cps	28 mw or 30 v p-p into 4000 ohms	73
202C	low frequency oscillator	1 cps to 100 kc	160 mw or 10 v into 600 ohms; 20 v open circuit	68, 69
204B	portable oscillator	5 cps to 560 kc	10 mw or 2.5 v into 600 ohms (battery operated)	70
205AG	audio signal generator	20 cps to 20 kc	5 watts into 50, 200, 600 or 5000 ohms	74
206A	audio signal generator	20 cps to 20 kc	+ 15 dbm into 50, 150 and 600 ohms; 10 v open circuit	75
233A	carrier test oscillator	50 cps to 500 kc	3 w into 600 ohms	72
241A	pushbutton oscillator	10 cps to 1 mc	10 mw or 2.5 v into 600 ohms	71
650A	wide-range test oscillator	10 cps to 10 mc	15 mw or 3 v into 600 ohms	76

Digital Data Systems, Instruments

Model ¹	Instrument	Features, Uses	Page
2010A-F	data acquisition systems	feature low-level measurements in presence of common mode noise and/or superimposed noise; measure voltage (0.1 v to 1000 v full scale), frequency and, with options, ac voltage, resistance; provide permanent record of data	14
2530	binary/decimal register	transfers data to parallel-entry card punches, digital comparators, displays; operates two instruments simultaneously	15
2540	coupler	operates with serial-entry tape punches, card punches, typewriters, Flexowriters; optional output codes, formats	16
2545	coupler	operates with Teletype BRPE II Tape Punch, records at 110 characters/sec	15
2900A	input scanner	scans up to 50 1-wire or 25 2-wire inputs, upper limit selectable at front panel; maximum scanning rate 25 channels/sec	15
2901	input scanner	scans 25 3-wire inputs, programs systems functions; operates with 2902, 2903, 2904 Slave Scanners for 100-channel capacity	15
2911	input scanner	offers guarded crossbar switch for common mode noise rejection; scans 600 1-wire, 300 2-wire, 200 3-wire or 100 6-wire inputs	15
6242	digital data plotting system	accepts data from perforated tape or from punched card reader; manual entry also possible; 4-digit resolution both axes	14
6575	digital magnetic tape plotting system	operates from binary-coded decimal or binary tapes; automatic plotting, search	14

¹Dymec Instruments

Recorder Amplifiers, Accessories

Model	Instrument	Characteristics	Page
F3 ²	line follower	reads recorded curves without need for magnetic ink retracing, follows slopes to 85°	17
101 ²	waveform translator	permits plotting of repetitive oscilloscope traces on x-y recorder, down 3 db at 200 kc	17
860-4000 ³	FIFO dc amplifier	solid state; amplifies high frequency signals from wideband transducers, 10 kc bandwidth; provides gain to 1000; for use with oscillographic recorders	114
860-4200 ³	floating dc amplifier	solid state; useful for precision data reduction from resistance bridge transducers, thermocouples; 50 kc bandwidth; maximum gain of 1000	115
860-4300 ³	differential dc amplifier	solid state; narrow band, low noise amplifier for use with thermocouples, strain gages; isolated, floating input, output; gain 1000	116
Preamplifiers for 150, 350, 850, 950 Series Recorders ³			10
Motion, pressure, force transducers ³ ; dc excited miniature differential transducers, Linearsyn differential transformers, differential and single-ended liquid, gas, pressure transducers			11

²F. L. Moseley Co.

³Sanborn Company

Distortion, Wave Form Analyzers - 20 CPS to 1.5 MC

Model	Instrument	Frequency Range	Features	Page
302A	waveform analyzer	20 cps to 50 kc	oscillator tuned voltmeter; measuring range, 30 μ v to 300 v	78, 79
310A	waveform analyzer	1 kc to 1.5 mc	10 μ v to 100 v, digital frequency readout	80, 81
330B,C,D	audio distortion, AM, FM monitors	20 cps to 20 kc	includes input amplifier, VTVM	82, 83

Signal Generators – 50 KC to 40 GC

Model	Instrument	Characteristics	Frequency Range	Page
202H ^a	FM-AM signal generator	output 0.1 μ v to 0.2 v; FM deviation range 0 to 250 kc; AM range 0 to 100%	54 to 216 mc	13
202J ^a	FM-AM signal generator	output 0.1 μ v to 0.2 v; FM deviation range 0 to 300 kc; AM range 0 to 100%	195 to 270 mc	13
211A ^c	aircraft signal generator	output 0.1 μ v to 0.2 v; VOR and ILS localizer calibrator	88 to 140 mc	13
225A ^a	FM-AM signal generator	output 0.1 μ v to 0.1 v; FM deviation range 0 to 60 kc; AM range 0 to 30%	10 to 500 mc	13
230A ^a	signal generator power amplifier	output 0 to 15 v; provides rf gains of 24 to 30 db	10 to 500 mc	13
232A ^a	glide slope signal generator	output 1 μ v to 0.2 v; ILS glide slope calibrator	329.2 to 335 mc	13
235A ^a	navigation aid test set	output -10 dbm to -100 dbm; DME and ATC transponder calibrator	962 to 1213 mc	13
240A ^a	sweep signal generator	output 1 μ v to 0.3 v; FM deviation 1 to 30%	4.5 to 120 mc	13
245C, D ^a	signal generator calibrator	output 5, 10, 20 μ v (245C), 0.5, 1, 2 μ v (245D); AM range 10 to 100%	500 kc to 1000 mc	13
606A	signal generator	output 0.1 μ v to 3 v into 50 ohms; constant output impedance, versatile modulation	50 kc to 65 mc	210, 211
608C	vhf signal generator	output 0.1 μ v to 1 v into 50 ohms; CW, pulse, amplitude modulation	10 to 480 mc	212, 213
608D	vhf signal generator	output 0.1 μ v to 0.5 v, crystal calibrator	10 to 420 mc	212, 213
612A	uhf signal generator	output 0.1 μ v to 0.5 v into 50 ohms; pulse, CW square wave or amplitude modulation	450 to 1230 mc	214, 215
614A	uhf signal generator	output 0.1 μ v to 0.157 v into 50 ohms; pulse, CW or frequency modulation	800 mc to 2.1 gc	220, 221
616B	uhf signal generator	output 0.1 μ v to 0.223 v into 50 ohms; pulse, CW or frequency modulation	1.8 to 4.2 gc	220, 221
618B	shf signal generator	output 0.1 μ v to 0.223 v into 50 ohms; pulse, CW, square wave, frequency modulation	3.8 to 7.6 gc	222, 223
620A	shf signal generator	output 0.1 μ v to 0.223 v into 50 ohms; pulse, square wave, frequency modulation	7 to 11 gc	222, 223
623B ^b	shf test set	output 70 μ v to 0.223 v into 50 ohms; pulse, frequency or square wave modulation; separate power, wave meter section	5925 to 7725 mc	230
624C ^b	X-band test set	output 2.23 μ v to 0.223 v into 50 ohms; pulse, frequency or square wave modulation; separate meter section	8.5 to 10 gc	230
626A	shf signal generator	output +10 dbm to -90 dbm; pulse, square wave, frequency modulation	10 to 15.5 gc	224, 225
628A	shf signal generator	output +10 dbm to -90 dbm; pulse, square wave, frequency modulation	15 to 21 gc	224, 225
938A, 940A	frequency doublers	driven by 626A or 628A Signal Generators, 686C or 687C Sweep Oscillators	18 to 26.5 gc; 26.5 to 40 gc	226, 227
5636 ^b	H-band test set	output +15 dbm to -86 dbm; frequency, pulse or square wave modulation	7.1 to 8.5 gc	230
8614A	uhf signal generator	output +10 dbm to -127 dbm; pulse, square wave, amplitude, frequency modulation	800 to 2400 mc	216, 217
8616A	uhf signal generator	similar to 8614A except for frequency range	1.8 to 4.5 gc	216, 217
8714A	modulator	provides sophisticated high-speed, low-jitter modulation with signal generator	800 to 2400 mc	218
8716A	modulator	provides sophisticated high-speed, low-jitter modulation with signal generator	1.8 to 4.5 gc	218

^aBoonton Instruments.

^bDymec Instruments.

Oscillographic, X-Y, Strip-Chart, Digital Recorders, Printers

Model	Instrument	Characteristics	Page
2D Series ^a	x-y recorders	11" x 17" graph paper, 0.5 mv to 50 v/div, dc; 0.1 to 20 v/div, ac	16
2FR ^a	two-pen x-y recorder	11" x 17" graph paper, 0.5 mv to 50 v/div, dc; 10 ranges	16
65 ^a	automatic chart advance x-y recorder	10" x 10" recording area, 0.5 mv to 50 v/div, dc; 16 ranges	16
7 ^a	table or wall x-y recorder	32" x 32" graph paper, 1 mv to 10 v/div, dc; 13 ranges	16
83 ^a	two-pen strip-chart recorder	70" roll charts (120 ft. long), 6 chart speeds, remote control, 0.5 mv to 20 v/div, 15 ranges	17
135, 136 ^a	compact x-y recorders	8 1/2" x 11" graph paper, 0.5 mv to 50 v/div, 16 ranges	16
150 Series ^a	oscillographic recorders	heated stylus recording of rectangular coordinates; dc to 100 cps; 10 μ v/div to 0.1 v/div, 18 speeds, 1 to 8 channels	10
296, 297 ^a	portable oscillographic recorders	dc to 125 cps, 0.1 v/mm without preamps, two channels; models differ only in preamps; 350 series with the 296 and miniaturized 850 with 297	9
299, 301, 302 ^a	portable direct writers	dc to 100 cps, one channel; 299, 10 mv/div to 10 v/div; 301, 10 μ v rms/div with amplifier for inductive transducers, etc.; 302, phase-sensitive demodulator	9
320, 321, 322 ^a	portable oscillographic recorders	dc to 125 cps; 320, 0.5 to 20 mv/mm and v/cm; 321, 10 μ v rms/mm to 100 mv/mm; 322, 10 mv/mm to 10 v/mm	9
350 Series ^a	oscillographic recorders	maximum performance systems; response to 150 cps, 2 μ v/div to 5 v/div, 10 ranges; 18 speeds, 6 or 8 channels	10
360, 361 ^a	event recorders	record on/off events as brief as 1.3 ms on dry-process charts; 30 to 120 channels	11
560, 561B ^a	digital recorders	record counter measurements at rates up to 5 per second, 11-digit parallel entry	144, 145
562A ^a	digital recorder	solid state, flexible input, maximum 5 prints per second, 11 columns	146, 147
565A ^a	digital printer	digital printer for custom installation, 11 columns, 11 characters per column, maximum 5 prints per second	148
650 Series ^a	high-frequency oscillographic recorders	record signals to 3 kc over 8" amplitude, to 5 kc over 4" amplitude, 1 to 24 channels	11
670B ^a	optical x-y recorder	response to 130 cps, writing speed to 2500"/sec; uses ultra-violet-sensitive paper (daylight loading)	11
680 Series ^a	compact strip-chart recorders	solid state, 8 chart speeds, 0.5 mv to 10 v/div, 10 ranges	17
850 Series ^a	multi-channel oscillographs	miniaturized preamps, 2" x 7" with 350 or 297 Series recorders; to 16 channels, interchangeable amplification	10
950 Series ^a	multi-channel oscillographs	maximum economy system; maximum flexibility for use with basic 6- or 8-channel 350 recorder; variable gain options	10
2000 Series ^a	magnetic tape recorders	seven-channel FM or direct record/reproduce recording, 4 speeds, 50 kc bandwidth	11

^aF. L. Moseley Co.

^bSanborn Company

^cHewlett-Packard Co.

Regulated DC Power Supplies

Model	Instrument, Characteristics	Output	Load Regulation (mv)	Line Regulation (mv)	Page
200D	plug-in vacuum tube power supply, complete in one compact model	150-312 v dc, 0-0.8 a	30	± 60	255
200DX	similar to 200D except for output	100-260 v dc, 0-0.8 a	30	± 60	255
505A	Auto-Series, Auto-Parallel, high efficiency solid state power supply; variable current limit	0-72 v dc, 0-5 a, continuously variable	0.5% combined		254
510A	same as 505A, except for output	0-36 v dc, 0-10 a	0.5% combined		254
520A	same as 505A, 510A, except for output	0-36 v dc, 0-25 a	0.5% combined		254
711A*	vacuum tube power supply with voltmeter and ammeter, dual overload protection, auxiliary 12 v ac (3 a) output	0-500 v dc, 0-0.1 a continuously variable	1000 or 0.5%	1000 or 0.5%	255
712B*	triple output vacuum tube supply with voltmeter and ammeter; auxiliary 6.3 v ac at 10 a output	0 to + 500 v dc, 0-0.2 a - 300 v dc (fixed), 0-0.05 a 0 to - 150 v dc, 0-0.005 a continuously variable	50 50 50	± 100 ± 100 ± 100	255
715A*	vacuum tube supply to power klystron tubes with auxiliary 6.3 v ac, 1.5 a output, direct reading calibrated voltage controls	- 250 to - 400 v, 0.03-0.05 a 0 to - 900 v, 0-10 μa continuously variable	1% 1%	1% 1%	257
716A*	vacuum tube supply to power klystron tubes with modulation flexibility, direct reading calibrated voltage controls	- 250 to - 800 v, 0-0.1 a 0 to - 800 v 6.3 v (adj.), 0-2 a continuously variable	0.05% — —	0.05% 0.05% 1%	257
721A*	solid state supply with current limit switch	0-30 v dc, 0.15 a continuously variable	30 or 0.3%	± 15 or 0.3%	249
723A*	solid state Auto-Series, Auto-Parallel operation	0-40 v dc, 0-0.5 a continuously variable	20	10	249
726AR*	solid state rack mount supply, variable current limit	0-60 v dc, 0-2 a continuously variable	5	2.5	252
800A-2	solid state dual supply; two sides can be used in series for double voltage output at same current	0-36 v dc, 0-1.5 a continuously variable	5	5	249
800B-2	solid state dual supply	0-36 v dc, 0-2.5 a continuously variable	10	5	249
801C	solid state strain gage supply; multiple shielding	0-25 v dc, 0-0.2 a continuously variable	2	2	256
802B	solid state dual supply can be used to double output voltage at same current	0-36 v dc, 0-1.5 a continuously variable	3.6 or 0.01%	3.6 or 0.01%	252
808A	solid state supply with Auto-Series, Auto-Parallel operation, variable current limit	0-36 v dc, 0-5 a continuously variable	3.6 or 0.01%	3.6 or 0.01%	250
809A	solid state supply with Auto-Series, Auto-Parallel operation, variable current limit	0-36 v dc, 0-10 a continuously variable	7.2 or 0.02%	7.2 or 0.02%	250
810B	solid state supply, Auto-Series, Auto-Parallel operation, variable voltage and current limit	0-60 v dc, 0-7.5 a continuously variable	10 or 0.02%	5 or 0.1%	250, 251
812C	solid state, eight-range supply	0-32 v dc, 0-10 a	16 or 0.05%	10 or 0.03%	252
814A	solid state supply, Auto-Series, Auto-Parallel operation, variable current limit	0-36 v dc, 0-26 a continuously variable	10 or 0.03%	10 or 0.03%	250, 251
855B	solid state Auto-Series, Auto-Parallel supply, adjustable voltage and current limits	0-18 v dc, 0-1.5 a continuously variable	5 or 0.03%	5 or 0.03%	246, 247
865B	solid state Auto-Series, Auto-Parallel supply, with adjustable voltage, current limit	0-40 v dc, 0-0.5 a continuously variable	4 or 0.01%	4 or 0.01%	246, 247
980	compact solid state supply, 7" wide	0-100 v dc, 0-1 a continuously variable	5 or 0.02%	5 or 0.05%	249
881A	solid state Auto-Series, Auto-Parallel supply, variable current limit	0-100 v dc, 0-1 a continuously variable	5 or 0.02%	5 or 0.05%	250
890A	solid state supply, overload protection, convection cooling, no moving parts	0-320 v dc, 0-0.6 a continuously variable	20 or 0.007%	20 or 0.007%	255
895A	differs from 890A only in current output	0-320 v dc, 0-1.5 a	20 or 0.007%	20 or 0.007%	255
6204A	solid state, pushbutton range selection and Auto-Parallel operation	0-18 v dc, 0-0.6 a 0-36 v dc, 0-0.3 a continuously variable	10	10	248
6206A	same as 6204A except for output	0-32 v dc, 0-1 a 0-64 v dc, 0-0.5 a continuously variable	10	10	248
6224A	solid state supply, Auto-Series, Auto-Parallel, adjustable voltage and current limit	0-18 v dc, 0-3 a continuously variable	2 or 0.03%	2 or 0.02%	246, 247
6226A	solid state supply, large-scale meters, compact	0-36 v dc, 0-1.5 a continuously variable	2 or 0.02%	2 or 0.02%	246, 247
6242A	solid state Auto-Series, Auto-Parallel supply, variable current limit, two output ranges	0-32 v dc, 0-2 a 0-60 v dc, 0-1 a	3 or 0.02%	5 or 0.03%	250, 251
6244A	similar to 6242A, except for output, regulation; replaceable subassemblies	0-36 v dc, 0-3 a continuously variable	5 or 0.02%	2 or 0.01%	250, 251
6343A	solid state supply, remote programming; Auto-Series, Auto-Parallel operation, remote sensing	0-18 v dc, 0-0.3 a continuously variable	3 or 0.02%	3 or 0.02%	253
6344A	same as 6343A, except for output	0-18 v dc, 0-1 a continuously variable	3 or 0.02%	3 or 0.02%	253
6345A	same as 6343A, except for output	0-18 v dc, 0-2.5 a continuously variable	3 or 0.02%	3 or 0.02%	253
6346A	same as 6343A, except for output	0-36 v dc, 0-0.15 a continuously variable	3 or 0.02%	3 or 0.02%	253
6347A	same as 6343A, except for output	0-36 v dc, 0-0.5 a continuously variable	3 or 0.02%	3 or 0.02%	253
6348A	same as 6343A, except for output	0-36 v dc, 0-1.5 a continuously variable	3 or 0.02%	3 or 0.02%	253
6455A	solid state supply, high-efficiency, Auto-Series, Auto-Parallel operation, variable current limit	0-36 v dc, 0-75 a continuously variable	0.05% combined		254
6910A	dual crowbar protector provides two overload protection circuits in one package				256
6920A	meter calibrator calibrates dc and ac voltmeters to 1000 volts, dc and ac ammeters to 5 amps				256

*Hewlett-Packard Co., others are Harrison Laboratories

Swept Frequency Oscillators

Model	Instrument	Characteristics	Frequency Range	Page
682C	sweep oscillator	electronically swept; variable sweep width and rate; pulse, square wave, frequency and amplitude modulation	1 to 2 gc	228, 229
683C	sweep oscillator		2 to 4 gc	228, 229
684C	sweep oscillator		4 to 8.1 gc	228, 229
H01-686C	sweep oscillator		7 to 11 gc	228, 229
686C	sweep oscillator		8.2 to 12.4 gc	228, 229
687C	sweep oscillator		12.4 to 18 gc	228, 229

Microwave Test Instruments*

Model	Instrument	Characteristics, Uses	Frequency Range	Page
340B†	noise figure meter	fast, simple noise figure measurement, alignment	30 and 60 mc	184, 185
342A†	noise figure meter	accurate versatile noise figure measurement	30, 60, 70, 105 and 200 mc	184, 185
343A-349A	noise sources	for use with noise figure meters, selectable impedance for IF and rf amplifier measurement	10 mc to 18 gc	185
344A†	noise figure meter	continuous noise figure measurement on operating radars, remote modulator, solid state	30 mc	183
415B,D	standing wave indicators	swr or null indicator, 0 to 70 db attenuation, sensitivity 0.1 μ v	frequency 1000 cps \pm 2%, 6%	190, 191
416B	ratio meter	continuous swept frequency presentation for reflection coefficient measurement	1000 cps \pm 40 cps	192
417A	vhf detector	for use with hp 803A approx. 5 μ v sensitivity	10 to 500 mc	234
430C	microwave power meter	measures rf power 0.1 to 10 mw	bolometer mounts from 10 mc to 40 gc	196
431B	power meter	stabilized rf power measurements, 0.01 to 10 mw	bolometer mounts from 10 mc to 40 gc	198, 199
434A	calorimetric power meter	measures power, 10 mw to 10 watts	dc to 12.4 gc	200, 201
489A-495A	traveling-wave tube amplifiers	30 db gain, 1 watt maximum output	1 to 12.4 gc collectively	202, 203
803A	vhf bridge	for measuring vhf impedance, swr; 2 to 2000 ohms magnitude — 90° to + 90° phase angle	55 to 500 mc	234

*For a "Quick Reference Index" to coaxial and waveguide equipment, see tables on pages 168-181.

†Not available in Europe

Voltsmeters and Ammeters—DC to 1 GC

Model	Instrument	Frequency Range	Full Scale Range	Input Impedance (voltsmeters only)	Page
22 ²	servo voltmeter	dc	3 mv to 300 v	—	17
60D ²	logarithmic converter	20 to 20,000 cps	converts ac voltage, dc voltages to dc voltages proportional to the log of the positive peak amplitude of input voltages	—	17
353A	patch panel, attenuator and impedance matching network	50 cps to 560 kc	+ 10 dbm maximum level	135, 600, 900 ohms and bridging (10K), center tapped	93
400D	wide range ac voltmeter	10 cps to 4 mc	1 mv to 300 v, 12 ranges	10 megohms, 25 max. pf shunt	88, 89
400H	high accuracy wide range ac voltmeter	10 cps to 4 mc	1 mv to 300 v, 12 ranges	10 megohms, 25 max. pf shunt	88, 89
400L	logarithmic scale, wide range ac voltmeter	10 cps to 4 mc	1 mv to 300 v, 12 ranges	10 megohms, 25 max. pf shunt	88, 89
403A 403B	battery operated, portable ac voltmeters	1 cps to 1 mc 5 cps to 2 mc	1 mv to 300 v, 12 ranges	2 megohms, 40 max. pf shunt	92
4058R,CR	dc digital voltmeter	dc	0.999 v to 999 v, automatic range	11 megohms	101
410B	ac, dc voltmeter, ohmmeter	dc; ac, 20 cps to 700 mc	1 to 1000 v dc 1 to 300 v ac 10 ohms to 10 megohms	dc, 122 megohms ac, 10 megohms, 1.5 pf shunt	94
410C	ac, dc voltmeter; dc ammeter; ohmmeter	dc; ac, 20 cps to 700 mc	15 mv to 1500 v dc 1.5 μ a to 150 ma dc 0.5 v to 300 v ac 10 ohms to 10 megohms	dc, 10 to 100 megohms, depending on range; ac, 10 megohms, 1.5 pf shunt	95
411A	rf millivoltmeter	500 kc to 1 gc	10 mv to 10 v	see specifications	96, 97
412A	dc voltmeter, ammeter, ohmmeter	dc	1 mv to 1000 v, 13 ranges 1 μ a to 1 a	10 to 200 megohms, depending on range	98
413A	dc null voltmeter	dc	1 mv to 1000 v, 13 ranges	10 to 200 megohms, depending on range	99
425A	sensitive dc voltmeter, ammeter	dc	10 μ v to 1 v, 11 ranges 10 μ a to 3 ma	1 megohm \pm 3%	100
428A 428B	dc ammeters, clip-on	dc	3 ma to 1 amp 1 ma to 10 amps	—	106, 107
456A	ac current probe	converts ma to mv for direct current readings on scope, VTVM		—	108
457A	ac-to-dc converter	50 cps to 500 kc	100 μ v to 300 v ac 0 to 1 v dc output	1 megohm, 30 pf shunt	102
738AR	voltmeter calibrator	dc; 400 cps sine wave	300 μ v to 300 v	works into 3 to 10 megohms	110
739AR	frequency response test set	5 cps to 10 mc (with 200SR oscillator)	1 mv to 3 v output	—	110
2210, 2211A,B ¹	voltage-to-frequency converters	dc	1 to 1000 v	1 megohm, 200 pf shunt	14, 15
2401A ¹	integrating digital voltmeter	dc	0.1 to 1000 v	100K to 10 megohms	103
2410A ¹	ac-ohms converter for use with 2401A integrating digital voltmeter	ac, 50 cps to 100 kc	ac, 0.1 v rms to 1000 v full scale; resistance, 100 ohms to 10 megohms; 300% over-ranging	1 megohm, 100 pf shunt	103
3400A	rms voltmeter	10 cps to 8 mc	1 mv to 300 v rms, 12 ranges	10 megohms, 25 pf shunt	90, 91
3440A	digital voltmeter	dc	9.999 to 999.9 v, 3 ranges	10.2 megohms	104, 105
3550A	portable test set includes hp 353A (above)	oscillator, 5 cps to 560 kc	voltmeter, 0.001 to 300 v rms	oscillator output 600 ohms voltmeter 2 megohms	93
5207-1 ¹	voltage-to-frequency converter	dc	0.1 v to 1000 v 5 ranges	1 megohm	15
71029A-11044A	voltmeter accessories, including dividers, shunt resistors and connectors			—	109

¹Dymec instruments. ²Moseley Co.

Square Wave, Pulse, and Digital Delay Generators

Model	Instrument	Characteristics	Frequency Range	Page
211A	square wave generator	output — 3.5 v p-p across 75 ohms and — 27 v p-p across 600 ohms	1 cps to 1 mc	57
212A	pulse generator	pulse length 0.07 to 10 μ sec, output 50 v across 50 ohms	50 to 5000 cps	58
213B	pulse generator	0.1 nsec risetime; 175 mv into 50 ohms	0 to 100 kc	61
214A	pulse generator	100v pulses into 50 ohms; risetime 10 to 15 nsec	0 to 1 mc	59
215A	pulse generator	1 nsec risetime; output 10 v peak into 50 ohms; continuous control over pulse length, delay	0 to 1 mc	60, 61
218AR	digital delay generator	time interval 1 to 10,000 μ sec; adjustable in 1 μ sec steps	10 cps to 10 kc	62
219A,B,C	plug-ins for 218AR	dual trigger, pulse, duration plug-ins	—	62

Frequency Measuring, Monitoring Equipment

Model	Instrument	Features, Uses	Frequency Range	Page
100E	frequency standard	aging rate 5/10 ⁶ per week	6 sine, 10 cps to 1 mc; 4 pulse, 10 cps to 10 kc	156
101A	oscillator	1 mc time base, aging rate 5/10 ⁶ per week	1 mc and 100 kc fixed	156
103AR	quartz oscillator	frequency and time standard, aging rate 5/10 ¹⁰ per day	1 mc and 100 kc fixed	157
104AR	quartz oscillator	frequency and time standard, aging rate 5/10 ¹⁰ per day	5 mc, 1 mc and 100 kc fixed	157
107AR, 8R	quartz oscillators	frequency and time standards; aging rate $\leq 5/10^{10}$ per 24 hours; withstands environmental extremes	5 mc, 1 mc and 100 kc fixed	158
114BR	time comparator	provides 0 to 999 msec delay in 1 msec steps, use for time comparisons in time standard systems		160
115BR, CR	frequency dividers and clocks	time comparisons between frequency standards, 100 kc input		159
500B, C	electronic frequency meter	for rapid frequency measurements, input 0.2 to 250 v	3 cps to 100 kc, 180 to 6,000,000 rpm	150
506A	optical tachometer pickup	phototube and light source, output 1 v rms, for measuring rps and rpm	60 to 300,000 rpm	151
508A-D	tachometer generators	for measuring shaft speed, output 60, 100, 120, 360 cycles per revolution	15 to 40,000 rpm	161
521A-E	Industrial electronic counters	direct reading, 4 or 5-place in-line or columnar readout; measure frequency, speed	1 cps to 120 kc	134
521G	electronic counter	direct reading, accuracy ± 1 count $\pm 0.1\%$; 5-place readout; measure frequency, speed	1 cps to 1.2 mc	134
522B	electronic counter	measures frequency, period, time interval, 5-place resolution, aging rate 10/million per week	10 cps to 120 kc	135
523C	electronic counter	measures frequency, period, time interval, aging rate 2/10 ⁶ /week, 6-place in-line readout	10 cps to 1.2 mc	136, 137
523D	electronic counter	same as 523C except 6-place neon readout		136, 137
524C	frequency counter	measures frequency, period, 5/10 ⁶ per week aging rate, digital readout	10 cps to 10.1 mc (freq.) 0 cps to 100 kc (period)	138, 139
524D	frequency counter	same as 524C except neon readout		138, 139
525A-C	plug-ins for 524's	extend frequency range of 524's retain counter accuracy	10 to 510 mc	139, 140
526A-D	plug-ins for 524's	four units: video amplifier, time interval unit, period multiplier, phase unit		139, 140
540B	transfer oscillator	extends range of 10 mc electronic counters to 12.4 gc	10 mc to 12.4 gc	142, 143
570A 571B	digital clocks	in-line, 6-place digital readout; add time of day data to hp digital recorders		148
P932A	harmonic mixer	mixer for use with 540B; 100 mw max. input; 0.1 mv min. output with 0 dbm signal input	extends 540B range to 18 gc	143
P934A	harmonic mixer	mixer, 100 mw max. input; 0.5 mv min. output with 0 dbm signal input	2 to 12.4 gc	143
2040A ¹	frequency measuring system	consists of 2590A Frequency Converter, 5243L Counter with 5253A Frequency Converter, 562AR Digital Recorder	dc to 12.4 gc	141
2590A	microwave frequency converter	combines functions of transfer oscillator, transfer oscillator synchronizer; measures to 12.4 gc with 5243L Counter, 5253A Frequency Converter	dc to 12.4 gc	141
5100A, 5110A	frequency synthesizer	5 billion digitally-selected frequencies with crystal stability	0.01cps to 50 mc in 0.01 cps steps	154, 155
5211A, B	solid state electronic counters	measure frequency, ratio, use line frequency as time base, 4-digit resolution	300 kc max. counting rate	124, 125
5212A, 5512A	solid state electronic counters	measure frequency, period, ratio; 5-digit readout; differ only in display, neon and in-line respectively	2 cps to 300 kc	124, 125
5214L	preset counter	measures normalized ratio; ratio; normalized ratio; time for N events; and counts N, 10N or 100N events with output pulse at start and end of count	2 cps to 300 kc; N: 1 to 100,000	132, 133
5237A, 5532A	solid state electronic counters	measure frequency, period, ratio; 6-digit readout; differ only in display, neon and in-line respectively	2 cps to 1.2 mc	124, 125
5233L	solid state electronic counter	measures frequency, period, multiple period average, ratio, time interval; 6-digit in-line display	dc to 2 mc	126, 127
5242L, 5244L	solid state electronic counters	offer 7-digit resolution, in-line readout, aging rate 2 parts in 10 ⁷ /month	counting rates respectively, dc to 20 mc and dc to 50 mc	128, 129
5243L, 5245L	solid state electronic counters	offer 8-digit resolution, in-line readout, plug-in versatility, remote programmability	counting rates respectively, dc to 20 mc and dc to 50 mc	128, 129
5251A, 5253A, 5261A, 5262A	plug-ins for 5243L, 5245L	frequency converters, video amplifier, time interval unit, retain accuracy of counter	extend counter frequency to 512 mc, sensitivity to 1 mv; time interval measurements 1 μ sec to 10 ⁵ sec	130
5275A	time interval counter	7-digit display, 10 nsec resolution	10 nsec to 0.1 sec	131
5796 ¹	transfer oscillator synchronizer	phase-locks hp H06-540B Transfer Oscillator to unknown signal; eliminates drift problems	200 mc to 12.4 gc	141

¹Dymec Instruments

Other Instruments and Accessories

Model	Instrument	Characteristics	Frequency Range	Page
297A	sweep drive	automatic frequency sweep, 2 speeds, variable stops, x-axis output	10° to 64 revolutions	79
350C, D	attenuators	110 db in 1 db steps; C, 500-ohm level; D, 600-ohm level; for measurement of attenuation, gain	dc to 1 mc	118
450A	stabilized amplifier	20 and 40 db gain, response ± 0.5 db	10 cps to 1 mc	112
460AR, BR	wideband amplifier	15 or 20 db gain, rise time 0.003 μ sec	20 kc to 120 mc	113
466A	solid state ac amplifier	20, 40 db gain, response ± 0.5 db	10 cps to 1 mc	112
1110A	ac current probe	no loading; 1 mv/ma into high impedance; 0.5 mv/ma with 100-ohm termination	1700 cps to 50 mc	54
1111A	amplifier for 1110A	50 mv/ma max. sensitivity with 1110A probe	36 cps to 20 mc	54
1115A, 1116A	testmobiles	for mobile use of oscilloscopes, counters, other instruments		54
2411A ¹	guarded data amplifier	for use with 2401A Integrating Digital Voltmeter, adds 10 mv full scale five-digit range, overranging to 30 mv; can also be used as a +1 buffer amplifier		103
2460A ¹	solid state dc amplifier	maximum output of ± 10 v peak at 10 ma; plug-in versatility, chopper stabilized	depends on plug-in	117
2461A ¹	plug-ins for 2460A	for systems use, bench use, patch-panel flexibility, plus-one amplification	dc to 50 kc	117
10001A- 10025A	general purpose probes	voltage dividers, current and low frequency probes		55
10004A, 10005A	line matching transformers	connect balanced system to VTM, oscillators or 330B; max. level ± 22 dbm, ± 15 dbm	5 to 600 kc, 20 cps to 45 kc	111
10501A-11501A	cable assemblies		dc to 12.4 gc	111

¹Dymec Instruments



Registered Trademark of the Hewlett-Packard Company.

ABOUT HEWLETT-PACKARD



The Hewlett-Packard plant at Stanford Industrial Park is designed to combine maximum efficiency and pleasant working conditions. It provides approximately 400,000 square feet of floor space in four two-story buildings, plus a large underground storage area. Additional *hp* manufacturing and service facilities are maintained at the former Palo Alto *hp* plant now principally occupied by Hewlett-Packard's Dymec Division. Other *hp* manufacturing facilities are in operation at Loveland, and Colorado Springs, Colorado; Böblingen, Germany, and Bedford, England.

"The success of each Hewlett-Packard instrument is assured only when meticulous care is applied to every step in its design and production. The instrument must be of an overall quality to engender the user's highest pride of ownership."

David Packard

This statement of corporate purpose and philosophy by Hewlett-Packard's president underlies the steady growth of the company into one of the world's foremost designers and manufacturers of electronic measuring instruments.

In its first instrument, a resistance-capacity audio oscillator, Hewlett-Packard pioneered the resistance-capacity circuit which is now an accepted standard for test oscillator design. First produced in 1939, the oscillator was the forerunner of literally hundreds of precision measuring devices which are known, used and respected throughout the United States and in some 70 foreign countries.

Since its founding in Palo Alto, California, less than 25 years ago, Hewlett-Packard has built an organization of more than 6000 employees and an annual sales volume of over \$100 million. The company and its affiliates now have a dozen manufacturing plants, including two in Western Europe. Its sales and service offices are located in nearly every

major city in the free world.

Although Hewlett-Packard's growth has been dynamic and far-reaching, the company has never altered its original objective—to make significant contributions to the specialized field of electronic instrumentation. To this end, it has concentrated its energies and resources on developing instruments which provide the greatest possible usefulness, accuracy, convenience, dependability and dollar value.

Among the principal categories of Hewlett-Packard instrumentation are oscilloscopes, audio oscillators, voltmeters, noise and distortion analyzers, signal generators, power meters, electronic counters and a complete array of waveguide and coaxial instrumentation for microwave work.

Since quality products are germinated by a superior engineering effort, Hewlett-Packard maintains an aggressive research and development program. Over the past several years its R&D expenditures have averaged approximately 7% of

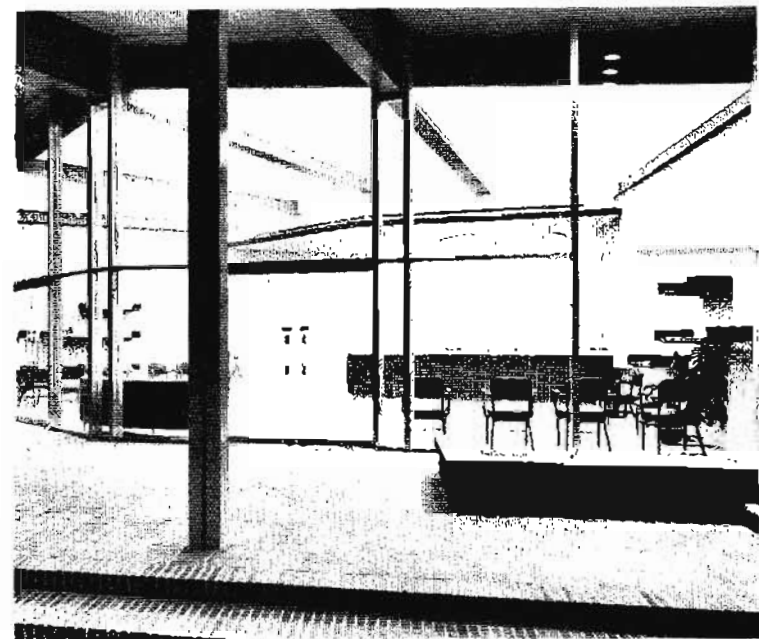

its gross income. As a result of this consistently high investment, its engineering staff and laboratory facilities are considered among the finest in the electronics industry.

On the production end of its operations, the company is manufacturing an increasing number of its own precision components, including photoconductors, semiconductor diodes and other solid state devices. These components contribute an unparalleled degree of accuracy, dependability and sophistication to Hewlett-Packard products.

The market for the company's instruments covers a broad spectrum of science and industry. From electronic development laboratories to radio and TV studios, from chemical research facilities to aircraft plants, from paper mills to medical laboratories, from hi-fi repair shops to space vehicle installations—Hewlett-Packard equipment is found in a wide variety of applications.

To fulfill the varying needs of its many thousands of customers, the company employs a large staff of factory-trained field engineers. These engineers, whose primary responsibility is to provide technical data and assistance to customers, are backed by a Palo Alto-based customer service group including more than 150 technicians and specialists. Together they assure Hewlett-Packard customers of prompt, efficient service in meeting their instrumentation requirements.

As Hewlett-Packard enters its second quarter-century of growth and progress, the company intends to continue providing instruments which represent the utmost in elegant design and fine craftsmanship—a standard of quality unmatched in the electronic test equipment field.



Hewlett-Packard representatives will gladly demonstrate *hp* equipment on your bench. You also may view the latest in precision instrumentation at *hp* exhibits in leading electronic shows.

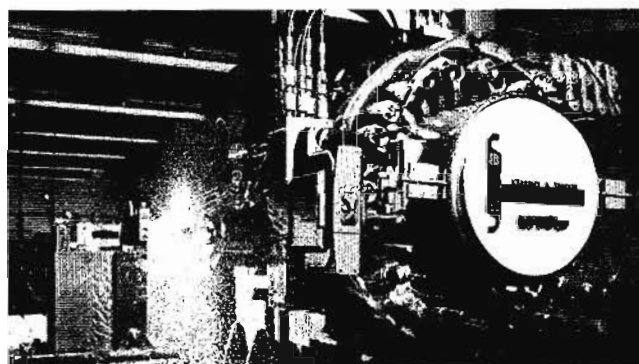

Programmed on tape, this automatic milling machine mills, drills, reams, taps, bores with utmost precision.

Production efficiency is increased with two *hp* innovations shown here, "roller skate" conveyers for handling assemblies between stations, and rotating "lazy susans" to speed wiring.



DIVISIONS and AFFILIATES

To assure that each instrument is the outgrowth of specialized engineering knowledge and manufacturing techniques, Hewlett-Packard has established four major product-oriented divisions — oscilloscopes, audio-video, frequency and time, and microwave. Operations of these four divisions are in Palo Alto, California; Loveland, Colorado; and Colorado Springs, Colorado.

In 1958 the company acquired 80% of the stock of the F. L. Moseley Co. of Pasadena, California. Since then it has acquired several other firms whose activities and products are directly related to the parent company's field of interest. These divisions and affiliates include:

BOONTON RADIO DIVISION — Founded in 1935, this firm was acquired by Hewlett-Packard in 1959. Located in Boonton, New Jersey, the division designs and manufactures instruments for measuring electrical circuit quality and testing aircraft guidance systems. It has gained wide recognition for its top quality impedance measuring equipment, particularly its Q meters.

DYMEC DIVISION — Founded as a separate company in 1956, Dymec became a Hewlett-Packard division in 1959. Located in Palo Alto, the division produces instruments and systems in two broad categories of electronic instrumentation — digital data and radio frequency. Using a unique approach to standard system design, Dymec instruments are combined with other Hewlett-Packard devices to form relatively inexpensive, pre-packaged instrument assemblies.

HP ASSOCIATES — This affiliated organization was formed by Hewlett-Packard in 1961. Headquartered in Palo Alto, it is engaged in a most important activity—solid state research and development. Its prime objective is to apply the highest level of technical competence to solid state R&D problems and to transform the results of its scientific endeavor into new and improved devices for electronic instrumentation. Information on available semiconductor devices can be obtained by writing directly to HP Associates, 2900 Park Boulevard, Palo Alto, California.

HARRISON LABORATORIES DIVISION — Founded in 1954, this firm was originally engaged in the production of television studio equipment. It later entered the power supply field, and today specializes in the design and manufacture of highly regulated dc power supplies. Located in Berkeley Heights, New Jersey, Harrison Laboratories became a division of Hewlett-Packard in 1961.

F. L. MOSELEY CO. — Founded in 1951, F. L. Moseley became an affiliate of Hewlett-Packard in 1958. The company is a leading manufacturer of precision X-Y recorders and related instruments. It is particularly noted for its top-quality line of Autograf recorders and accessory devices. The company has two plants in Pasadena, California.

PAECO DIVISION—Originally founded in 1951 as the Palo Alto Engineering Company, Paeco became a division of Hewlett-Packard in 1962. Located in Palo Alto, the division designs and manufactures Hewlett-Packard ac power supplies, static inverters, voltage regulators and frequency changers.

SANBORN COMPANY — Founded in 1917, this well-established company became an affiliate of Hewlett-Packard in 1961. The firm is a leading producer of medical diagnostic apparatus and since 1949 has also designed and manufactured a broad line of industrial instruments for measuring and recording such physical phenomena as stress, strain, pressure, speed, sound, vibration and temperature. Sanborn is headquartered in Waltham, Massachusetts.

Sanborn Instrumentation for Data Handling, Recording and Readout

Sanborn Co. Industrial Division now supplies more precision oscillographic recording systems and related instruments than ever before in its history. The product line covers the entire recording and data handling process from transducers to readout systems and includes six complete families of amplifiers; eight series of oscillographic, X-Y, event and magnetic tape recording systems, and numerous related instruments. The complete Industrial Division Catalog, available on request, gives detailed specifications and data. Write Industrial Division, Sanborn Company, Waltham 54, Mass.

Single-Channel Portable Direct Writers

Model 299 General Purpose DC Recorder

Reliable, compact, low-cost portable system for dc to 100 cps coverage. Sensitivity 10 mv/div. to 10 v/div., smooth gain control. Input balanced to ground, 5 megohms each side. Frequency response dc to 100 cps within 3 db. Max. non-linearity 1/2%, gain stability better than 1%. Two chart speeds, marker stylus and cal. zero suppression. 7" x 10 1/2" x 12" wide. 21 lbs. Price \$700.

Model 301 Carrier-Type Recorder

Identical package and recorder to 299, but amplifier for inductive transducers and strain gages. Sensitivity 10 μ v rms/div., 8-position attenuator. Frequency response, gain stability, linearity same as 299. Carrier frequency 2400 cps @ 5 v rms. Transducer imped. (incl. other bridge components.) 100 ohms min., input imped. 10,000 ohms. Uncalibrated zero suppression. Output connector for scope, etc. Price \$750.

Model 302 Phase-Sensitive Demodulator Recorder

Useful for testing servo systems and components. Same package and recorder as 299 above but with transistorized phase-sensitive demodulator-amplifier and power supply. DC output to galvanometer proportional to in-phase or 180° out-of-phase ac component with respect to reference. Sensitivity 0.5 mv, 10 atten. ratios, linearity better than 1%. Input impedance 100,000 ohms single-ended. Price \$750.

2-Channel Portables

Model 296 with Versatile 350 Preamplifiers

Model 297 with Miniaturized 850 Preamplifiers

Except for preamplifiers, Models 296 and 297 are essentially the same 2-channel direct writing systems. Model 296 uses the highly developed, max. performance 350 type; Model 297 the miniaturized 850 type (see table on page 10). Both systems offer 0.1 v/mm sensitivity (w/out preamps), freq. response from dc to 125 cps within 3 db, max. non-linearity of 1/2%, low drift and noise, two 50-mm wide channels, 4 chart speeds, paper take-up. Both have forced air cooling, transistorized current feedback power amplifiers and enclosed, velocity-damped galvanometers. Packaging can be in portable case, mobile cart or customer's cabinet. Less Preamps, Model 296, \$1575; Model 297, \$1675.

Model 320 General Purpose DC System

Completely solid state, inputs floating and guarded. Weight 55 lbs., occupies one cu. ft. Current-feedback power amplifiers. Sensitivity 0.5 to 20 mv/mm and v/cm. Input imped. 1/2 meg. on mv/mm ranges, 1 meg. on v/cm ranges. Max. non-linearity 1/2%. Freq. resp. dc to 125 cps within 3 db. Common mode reject. 140 db min. at dc. Operates vertically, horizontal or tilted. Price \$1650; rack mount 320R, \$1800. Model 320-300 Paper Takeup, \$125.

Model 321 Carrier System

Same size, weight and recorder features as Model 320, but provides excitation for and accurately records outputs of resistance bridges, variable reluctance, differential transformers and other ac-excited transducers. Sensitivity 10 μ v rms/mm to 100 mv/mm in 7 ranges. Frequency response dc to 125 cps within 3 db. Max. non-linearity 1/2%. Price \$1495; rack mount 321R, \$1645.

Model 322 General Purpose AC or DC System

Identical package and recorder features as Model 320, but with moderate gain direct-coupled amplifiers. Sensitivities 10 mv to 10 v per mm. Frequency response dc to 125 cps within 3 db. Common mode rejection 50:1. Max. non-linearity 1/2%. Model 322 with zero suppression, \$1395; 322A without z. s., \$1295; rack mount 322R, \$1545; 322AR, \$1445.

Sanborn Medical Instruments

Sanborn helped pioneer "electronic" electrocardiographs in the 1920's and now offers numerous clinical and research instruments. They include visual monitoring systems, cardiac monitors, blood cell counters and a wide variety of physiologic recording systems for teaching, research and surgery. Sanborn medical instruments are sold through branch offices and factory-authorized service agencies. Write Medical Division, Sanborn Company, Waltham 54, Mass., for details.

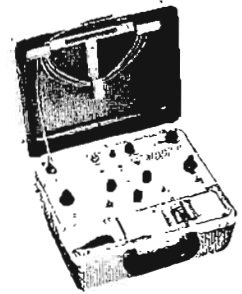

Model 299



Model 296

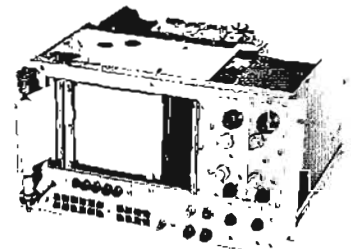

Model 297

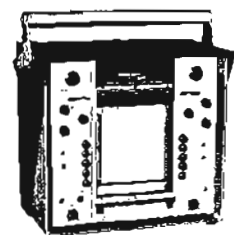

Model 320

Multi-Channel Oscillographs

Rectangular-Coordinate Recording by Heated Stylus

150 Series 1- to 8-Channel Systems

This widely used Sanborn design offers time-proven reliability, a choice of 12 interchangeable tube-type preamplifiers with individual channel plug-in preamps, and choice of upright, portable case or 4-ft. "pulpit" cabinet packaging. Primary features include: response to 100 cps within 2 db; sensitivity 10 $\mu\text{v}/\text{div}$ to 0.1 v/div (depending on preamp used); non-linearity less than 1%; individual-channel current feedback driver amplifiers and power supplies; rugged, high torque galvanometers. Recorders have 9 speeds (0.25 to 100 mm/sec), horiz. chart plane, timer/marker stylus, stylus heat controls, paper take-up and output connector on each channel for scope or meter.



150 Series

350 Series Maximum Performance Systems

These systems use plug-in preamplifiers of max. flexibility and signal handling capability, with flush-front recorders also used in 850 and 950 systems. Preamps with power supplies usable alone to drive scopes, meters, etc. System features: response to 150 cps within 3 db at 10 div peak-to-peak amplitude; sensitivity 2 $\mu\text{v}/\text{div}$ to 5 v/div depending on preamp used; transistorized, plug-in power amplifiers preceded by limiters to prevent loss of galvanometer damping; low voltage, enclosed galvanometers with velocity feedback damping; 9 electrically-shifted chart speeds selected by pushbutton, 9 more optional; 4 cm channel widths in 8-channel systems (5 cm in 6-channel); max. non-linearity less than 1/2%.



350 Series

850 Series Miniaturized Preamp Systems

Preamplifiers only 2" x 7" (eight occupy 7" x 19" of panel space), plus the flush-front recorder described under 350 systems, are the major components of 850 systems. Preamplifiers, while slightly less versatile than 350 types, offer greater economy in space and cost with no sacrifice in reliability or overall performance. They also permit the flexibility of 12-, 14- or 16-channel systems with 6 or 8 channels having interchangeable amplification, the remaining 6 or 8 channels with "all-alike" high, medium or low gain 950 amplification (see 950 description below). Series 850 preamps are also used in the 2-channel Model 297 system and Model 670B X-Y Recorder (see page 11). Max. non-linearity less than 1/2%.

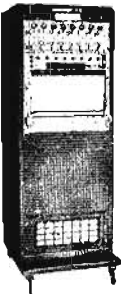

850 Series

950 Series Maximum Economy Systems

6- or 8-channel 350 recorder with 6- or 8-channel 950 amplifier—or 16-channel recorder (20 mm channels) with either two 950 amplifiers or one amplifier module plus eight 850 preamps. High, medium, medium-low or low gain 950 amplifiers have all channels alike on a single chassis. High gain has floating and guarded inputs, 100,000 ohms resistance, max. sensitivity of 10 $\mu\text{v}/\text{div}$, high common mode performance, low noise and drift. Medium gain also has floating and guarded inputs, transistorized circuitry, max. sensitivity of 0.5 mv/div. Medium-low gain has balanced to ground inputs 5 meg. each side, max. sensitivity of 10 mv/div, optional calibrated zero suppression. Economical low gain has single-ended inputs, 100,000 ohm res., 100 mv/div sensitivity, useful for computer and telemetry outputs. A 6- or 8-channel Carrier Amplifier provides 2.4 kc excitation and demodulation for transducers.



950 Series

DIRECT WRITING SYSTEMS SUMMARY

Number of Channels Avail.		150 Series	350 Series	850 Series	950 Series
		1, 2, 4, 6, 8	4, 6 or 8	4, 6 or 8	6, 8, 12, 14 or 16
Basic Assembly Prices (do not include preamps)	4-Channel	\$3250	\$3835	\$3200	Not available
	6-Channel	\$4870 (2 cabinets) \$4705 (single cabinet)	\$5215	\$4625	\$3000
	8-Channel	\$5780 (2 cabinets)	\$6270	\$5300	\$3300
	16-Channel	Not available	Not available	Price on Request	Price on Request
Preamplifier Types: (Add Series No. Prefix)		(Add Total Price of Preamps Chosen to Basic Assy. Price)			
-1000 DC		\$385*	\$265*	\$250*	-2000 Low Gain:
-1100 Carrier		\$425*	\$425*	\$365	6-Channel \$1500
-1200 Phase-Sens. Demod.		\$360	\$445	\$320	8-Channel \$1700
-1300 DC Coupling		\$220*	\$250*	\$225*	-2900 Med.-low Gain:
-1400 Logarithmic		\$305	\$450	Not available	6-Channel \$2200*
-1500 Low Level		\$435*	\$690*	\$435	6-Channel \$1800
-1800 Stabilized DC		\$470*	\$550*	\$375*	8-Channel \$2500*
-2300 AC Wattmeter		\$495	\$600	Not available	8-Channel \$2100
-2500 RMS Volt/Ammeter		\$440	\$600	Not available	-3400 Medium Gain:
-2600 Freq. Deviation		\$360	\$475	\$375	6-Channel \$3000
-2800 Freq. Meter		\$415*	\$425	Price on Request	8-Channel \$3500
					-1500 High Gain:
					6-Channel \$3000
					8-Channel \$3600

*Includes zero suppression

Instrumentation Tape Systems, Other Multichannel Recording Systems, Data Amplifiers and Transducers

650 Series DC—5 KC Optical System

System records 1 to 24 channels of high frequency signals—to 3 kc over full 8" amplitude, to 5 kc over 4" amplitude—with a single set of optical galvanometers. Amplification can be matched to application by choice of high, medium, low gain or carrier amplifiers in 6- or 8- channel 7" high modules. Max. system sensitivities, in order, are 2.5 mv/inch, 50 mv/inch, 0.5 v/inch and 500 μ v rms/inch. Recordings are made on 8" ultraviolet-sensitive paper easily loaded from front in normal room light. Traces fully developed within a few seconds after exposure to room light. Recorder features include 9 chart speeds, auto-printed timing and amplitude lines, viewing periscope, trace identification, marker control, remote control connector. Price 8-channel Optical Oscillograph (less amplifiers) with std. 2000 cps galvanometers, \$4200. 8-channel pre-amp., \$3780. Amplifiers optionally available to drive any optical galvanometer.



650 Series

670B Optical X-Y Recorder

Optical galvanometers and light beam recording on 8" x 8" ultraviolet-sensitive charts permit this system to have writing speeds of 2500"/sec and frequency response to 130 cps within 3 db at 8" peak-to-peak deflections. Such rapidly changing variables as velocity vs. acceleration of mechanical elements are well within the range of this recorder. Paper is daylight loading, reveals traces almost immediately after recording and does not require development. Model 850-1300B DC Coupling Preamps supply input to each axis; other 850 preamps may be used. Optional plug-in 670-800 Time Base Generator available (\$250). System price, including 850-1300B Preamps, \$2635. Optional Model 670-900 Grid Line Generator also available.

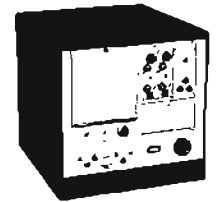

670B

30- to 120-Channel Event Recorders

Accurately record on/off events as brief as 1.3 ns on dry-process, electrically sensitive charts. "Pulsed writing" provides sharp, clean traces, low power consumption and prolonged stylus life. Recorders designed in accordance with MIL I-26600/2, Class 1B, rf Noise Spec. Optional choice of writing controls switch stylus voltages faster than typical relays or switches, eliminating their cost and installation. Model 360 records up to 120 channels on 16" wide charts; has 9 std. speeds, 9 more optional; occupies 14" x 19" panel space. Price \$3900. Model 361 portable or rack mounted 30-channel event recorder has 4 std. speeds, 4 more optional, takes only 8 3/4" of panel space in rack. Wide variety of solid state switching circuits available for use with either recorder. Specifications and prices available on request.

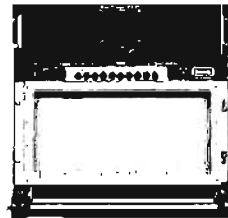

Model 360

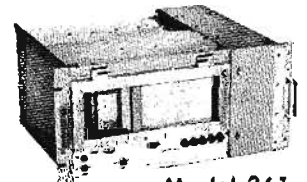

Model 361

Series 2000 Magnetic Tape System

Seven-channel FM or direct record/reproduce recording, 4 speeds, 1% system accuracy, non-linearity less than $\pm 0.5\%$ on dc, $\pm 1\%$ on ac. Transistorized, conforms to IRIG standards. Interchangeable FM and direct electronics for 7 channels, each only 7" high; 31 1/2" total system panel space; vertical cabinet or separate portable cases. Both record and reproduce amplifiers on same plug-in cards. Direct bandwidth 50 kc, fm 5 kc (at 30 ips). Standard 4 speeds 3 3/4 to 30 ips; optional 1 7/8 to 15 or 7 1/2 to 60 ips. Optional: voice channel amplifier, digital input card, push-pull input coupler, precision footage counter, loop adapter, remote control unit. Model 2007 basic assembly, \$5960; direct record/reproduce insert, \$155 ea.; FM insert \$180 ea.; direct equalization plug-in, \$30 ea. (one per channel per speed req.); FM freq. plug-in, \$40 ea. (one per channel per speed req.).



Series 2000

Also, new 7- and 14-channel seven speed tape systems available.

Miniaturized Data Amplifiers

Detailed descriptions on Pages 114 - 116.

Motion, Pressure and Force Transducers

(For complete information, write Transducer Division, Sanborn Co.)

581 Displacement Probe: Displacement Probes give f.s. recording on Sanborn pre-amp and recorder from 0.001" displacement. Max. non-linearity 1/2%. Ten versions, numerous adapters, from \$125 to \$185.

Linearsyn ® D. T.: Linearsyn differential transformers, strokes from $\pm 0.005"$ to $\pm 1.0"$. High sensitivity, shock and vibration immunity; immersible. Many specials available. Prices \$15 to \$60.

267 Pressure Transducers: Differential and single-ended liquid or gas pressure transducers, sensitivities 21 μ v/0.01 psig/volt excitation and 210 μ v/0.01 psig/volt excitation. Prices \$225 and \$250. Other ranges up to 10,000 psi.

FTA Transducer: Low force transducer available in standard ranges from 0-1 gram to 0-10,000 grams. FTA model (less adapter), \$175.

Model 7 DCDT: DC-excited miniature dc differential transformers—can drive dc meters or amplifiers directly. Displacement ranges $\pm 0.050"$ to $\pm 3.0"$. Model 7 DCDT-050 ($\pm 0.050"$ stroke), \$99.

LVsyn: ® LVsyn linear velocity transducers need no excitation. Rugged, immersible, unlimited resolution, linearity better than 1%. Prices from \$40 to \$120.

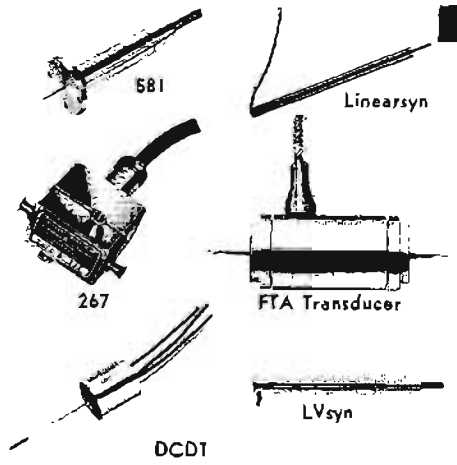

581

Linearsyn

267

FTA Transducer

DCDT

LVsyn

Boonton Impedance Measuring Instruments, FM-AM Signal Generators, Aircraft VOR/ILS/DME Test Equipment

Boonton Radio, established in 1934, has specialized in the design and manufacture of precision electronic laboratory instruments falling into three general areas: impedance measuring equipment, FM-AM signal generators and instruments for the calibration of aircraft navigation systems. Impedance measuring instruments currently manufactured include Q meters, rf bridges, production Q comparators, and transistor test equipment operating in the 1 kc to 610 mc range. FM-AM and sweep signal generators and accessory equipment cover the 100 kc to 500 mc portion of the spectrum and are designed to serve broadcast FM, vhf-tv, and telemetering, as well as general communications applications. Specialized signal generators are provided for the VOR and DME aircraft navigation systems, the ILS aircraft landing system, and the ATC beacon. For information on the entire Boonton line write Boonton Radio Company, Green Pond Road, Rockaway, New Jersey.

Q METERS

Type	RF Range	Total Q Range	Res. C. Range	L Range	Price
260A	50 kc - 50 mc	10 - 675	30 - 460 pf	0.09 μ h - 130 mh	\$ 925
190A	20 mc - 260 mc	5 - 1200	7.5 - 100 pf	4 m μ h - 8.5 μ h	\$ 975
280A	210 mc - 610 mc	10 - 25,000	4 - 25 pf	2.5 - 146 m μ h	\$2610

The Q Meter was first designed and introduced in 1934 as a means of measuring the Q or "Figure of Merit" of coils. Improved models and broadened applications have kept pace with a rapidly growing industry, and the Q Meter is recognized as a flexible, general purpose device with a broad field of application in the measurement of components and systems. The Q Meter consists of a self-contained, continuously variable, stable oscillator, whose controlled and measured output is applied to a calibrated, series-tuned resonant circuit. In the 260A and 190A, a high impedance vacuum tube voltmeter is connected across the internal variable capacitor portion of the tuned circuit to measure the reactive voltage in terms of circuit Q. In the 280A, Q measurements are made by measuring the percentage bandwidth of the resonance curve and the direct reading dials mechanically compute the transfer function and read out directly in circuit Q. Q meter applications include the measurement of coils, capacitors, resistors and dielectric materials.

RX METER

The RX Meter Type 250A is a completely self-contained rf bridge for use in measuring the equivalent parallel resistance and capacitance of two terminal networks. The instru-

ment includes an accurate, continuously tuned oscillator, high-frequency bridge, amplifier-detector, and null indicating meter.

RF Range: 500 kc to 250 mc.

Resistance Range: 15 to 100,000 ohms.

Capacitance Range: 0 to 20 pf (may be extended to 120 pf with auxiliary coils).

Inductance Range: 0.001 μ h to 100 mh (actual range depends upon frequency).

Measurement Voltage Level: 0.05 to 0.75 volts (may be reduced to 20 mv).

Price: \$1,600.

Q COMPARATOR

The Q Comparator Type 265A is designed for the rapid production inspection of coils, capacitors, resistors and other components for both Q and L-C. The instrument is essentially a "production Q meter" and consists of a swept-frequency oscillator, Q meter-type measuring circuit with detector, and CRT indicator which reads out % departure from a standard.

RF Range: 200 kc to 70 mc.

Q Range: 30 to 500.

% Q Range: \pm 25%.

L Range: 0.15 μ h to 15 mh (actual range depends upon frequency).

C Range: 5 pf to 0.01 μ f.

% L-C Range: \pm 5% or \pm 20% of standard, full scale.

Price: \$890.

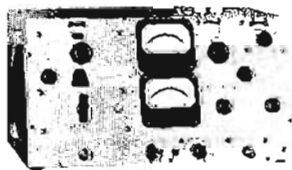

Q Meter
Type 260A

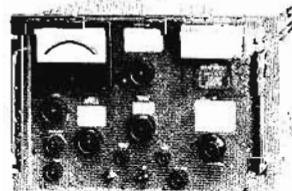

UHF Q Meter
Type 280A

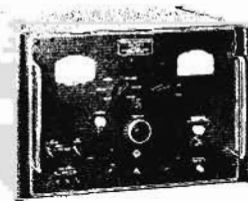

Signal Generator
Type 225A

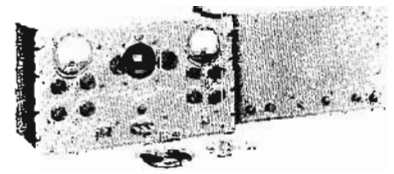

Crystal Monitored Signal Generator
Type 211A



Signal Generator
Power Amplifier
Type 230A

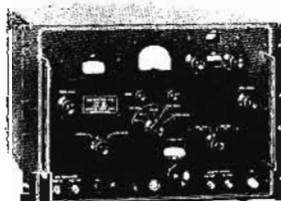

Navigation Aid
Test Set
Type 235A



Q Meter
Type 190A

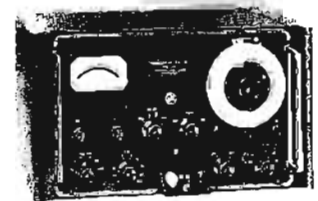

Transistor Test Set
Type 275A

9-76 225A 00225-90014
 41.50

TRANSISTOR TEST SET

The Transistor Test Set Type 275A is a completely self-contained instrument for the precise measurement of basic transistor parameters over a wide range of operating conditions. The test set may also be used to measure the characteristics of diodes and other semiconductor devices. Direct readout of alpha (short circuit current gain, grounded base), beta (short circuit current gain, grounded emitter), and input resistance (output shorted, grounded base) is provided with variable emitter current and collector voltage from the internal supplies.

- Alpha Range: 0.100 to 0.9999.
- Beta Range: 7 to 200.
- Input Resistance Range: 0.30 to 3000 ohms.
- Test Oscillator Frequency: 1000 cps.
- Collector Voltage Range: 0 to 100 volts, dc.
- Emitter Current Range: 0 to 100 ma dc (0 to 5 amps external).
- Price: \$935.

FM-AM SIGNAL GENERATORS

Type	RF Range	RF Output Range	FM Dev. Range	AM Range	Price
202H	54 mc - 216 mc	0.1 μ v - 0.2 v	0 - 250 kc	0 - 100%	\$1,365
202J	195 mc - 270 mc	0.1 μ v - 0.2 v	0 - 300 kc	0 - 100%	\$1,390
225A	10 mc - 500 mc	0.1 μ v - 0.1 v	0 - 60 kc	0 - 30%	\$1,050
240A	4.5 mc - 120 mc	1 μ v - 0.3 v	$\pm 1\%$ - $\pm 30\%$	30%	\$1,910

The Signal Generator, Type 202H, is designed for the testing and calibration of FM receiving systems in the areas of broadcast FM, vhf-tv, and general communications. The Type 202J, essentially identical to the 202H, is specifically designed for coverage of the vhf telemetering band. The Type 225A is a broadband, general-purpose instrument offering exceptional frequency stability. The Type 240A is a sweep signal generator and is designed for the alignment of broadband amplifiers. Univerters, Types 203B and 207H are available as accessories for each of these generators to extend the rf coverage down to 100 kc.

FM STEREO MODULATOR

The FM Stereo Modulator Type 219A is designed to provide a multiplex output signal in accordance with FCC Docket 13506 when fed with Left (L) and Right (R) audio stereo channel inputs and/or subsidiary communications FM sub-carriers (SCA). The output of the modulator may be switched to provide either (L+R), (L-R), 19 kc pilot carrier, or the complete multiplex signal which can either be

used directly or, in turn, to modulate the Type 202H FM-AM Signal Generator.

- (L) and (R) Frequency Range: 50 cps to 15 kc.
- SCA Frequency Range: 20 to 75 kc.
- Internal Oscillator Frequency: 1 kc.
- Output Level: 0 to 7.5 volts peak.
- Residual Hum and Noise: > 60 db below 100% output.
- Crosstalk: > 40 db below 100% output.
- Price: \$915.

SIGNAL GENERATOR POWER AMPLIFIER

The Signal Generator Power Amplifier Type 230A is designed to provide high level rf power from a conventional signal generator for such applications as receiver testing; voltmeter and wattmeter calibration; antenna, filter and component testing; attenuation measurements. The amplifier, because of its inherently low noise may also be used for low-level applications.

- RF Range: 10 to 500 mc.
- RF Output: 0 to 15 volts (across external 50 ohm load)
- RF Gain: 30 db (10-125 mc).
- 27 db (125-250 mc).
- 24 db (250-500 mc).
- RF Bandwidth: > 700 kc (10-150 mc).
- > 1.4 mc (150-500 mc)
- Price: \$1200.

SIGNAL GENERATOR CALIBRATORS

The Signal Generator Calibrators, Types 245C and 245D, are designed to provide a rapid and convenient means for checking and calibrating the rf output and amplitude modulation of signal generators. They will also provide a calibrated low-level rf output voltage for the precision testing of receiver sensitivity.

- RF Range: 500 kc to 1000 mc.
- RF Input Voltage Measurement Levels: 0.025, 0.05, 0.1 volts.
- RF Output Voltage: 5, 10, 20 μ v (245C).
- 0.5, 1, 2 μ v (245D).
- AM Range: 10 to 100%.
- Price: \$415. (245C).
- \$410 (245D).

AIRCRAFT VOR/ILS/DME/ATC BEACON TEST EQUIPMENT

Type	RF Range	RF Output Range	Calibrates	Price
211A	88 mc - 140 mc	0.1 μ v - 0.2 v	VOR & ILS Localizer	\$1,890
232A	329.3 mc - 335 mc	1 μ v - 0.2 v	ILS Glide Slope	\$2,075
235A	962 mc - 1213 mc	-10 to -100 dbm	DME & ATC Transponder	\$4,900



Q Comparator Type 265A

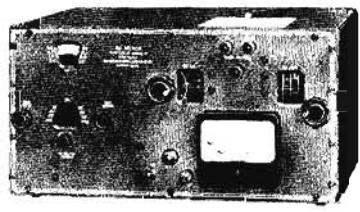

RX Meter Type 250A

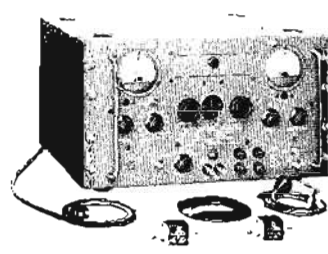

Glide Slope Signal Generator Type 232A

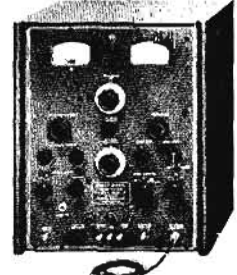

Sweep Signal Generator Type 240A

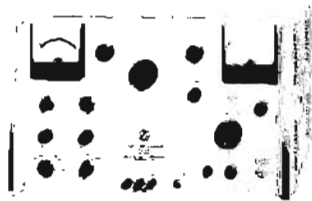

Telemetering Signal Generator Type 202J

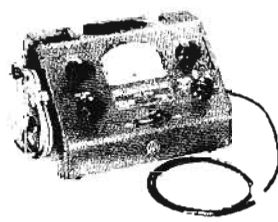

Signal Generator Calibrators Type 246C,D



FM Stereo Modulator Type 219A

DYMEC DIGITAL DATA, RF INSTRUMENTATION

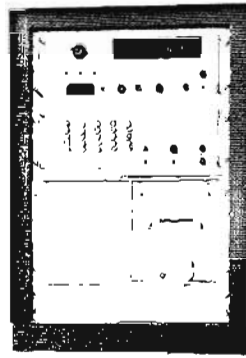

DY-2010A



DY-2010D

Dymec Division of Hewlett-Packard produces instruments for digital data acquisition and rf measurement and control. Designing for compatibility with standard *hp* instruments, Dymec also offers inexpensive packaged systems, engineered and tested for maximum performance and reliability and available at minimum cost with minimum delivery delay. Both the systems and the individual instruments are available from Dymec in the areas of data acquisition, data processing, component testing and rf measurement and control. RF instruments for frequency measurement include the *hp* 2590A Microwave Frequency Converter (page 141) and DY-5796 Transfer Oscillator Synchronizer (page 141). Complete frequency generation and control systems using the DY-2650A Oscillator Synchronizer (page 219) are available. Other elements of Dymec systems are described in appropriate sections of this catalog (pages 103, 117, 183, and 230). Data sheets on all instruments and systems, as well as a Dymec quick reference catalog are available on request.

Dymec Data Acquisition Systems

Here are basic standard systems which offer the common advantages of modest cost, fast delivery, high reliability derived from standard design and construction, and proved performance. The measuring element of each of the systems is the DY-2401A Integrating Digital Voltmeter, which permits accurate low-level measurements in the presence of severe common mode noise and/or superimposed noise. Thus, all Dymec Data Acquisition Systems are ideal for measuring and recording signals in the presence of common mode and superimposed noise caused by severe ground loop currents and other adverse situations. Basic systems measure dc voltage and frequency, with options available for measurement of ac voltage and resistance. All are automatic. Systems are available to provide a wide range of input scanning capabilities, plus a flexible assortment of output recording devices.

Common Specifications, DY-2010 Series

Effective Common Mode Rejection: Up to 130 db
Voltage Range: 0.1 v to 1000 v full scale, 5 ranges. Optional amplifier provides ± 10 mv full scale, 5-digit range. Over ranging to 300% on four most sensitive ranges.
Input Impedance: 10 megohms on 10 v and higher ranges, 1 megohm on 1 v range, 100,000 ohms on 0.1 v range. Optional amplifier provides 10,000 megohms on lower ranges.
Frequency Range: 10 cps to 300 kc, sample period 0.01, 0.1 or 1 sec.

Input: Floated and guarded signal pair for each channel, may be operated up to 500 v above chassis ground.
Display: 5-digit in-line readout; polarity, decimal point, measurement units, overload conditions automatically indicated. Storage holds display between readings.

Individual Systems

DY-2010A: Input: Up to 25 channels, expandable to 100 channels with up to 3 slave scanners. Output: Printed paper tape, up to 5 channels/sec. Effective common mode rejection, 105 db. \$8675.
DY-2010B: Input: Same as 2010A. Output: Perforated tape, up to 10 channels/sec. Effective common mode rejection, 105 db. \$10,800.
DY-2010C: Input: 200 guarded 3-wire inputs or 600 1-wire non-guarded inputs. Output: Printed paper tape, up to 5 channels/sec. Effective common mode rejection, 130 db. \$10,965.
DY-2010D: Input: Same as 2010C. Output: Perforated tape, up to 10 channels/sec. Effective common mode rejection, 130 db. \$12,850.
DY-2010E: Input: Same as DY-2010B. Output: Punched card on IBM 526 Punch, nominally 1 channel/sec. Effective common mode rejection, 105 db. Price on request.
DY-2010F: Input: Same as 2010C. Output: same as 2010E. Effective common mode rejection, 130 db. Price on request.

Data Processing Systems

Dymec Data Processing Systems produce graphical plots from digital information stored in punched cards, perforated tape or magnetic tape.

The DY-6242 accepts data directly from perforated tape or operates from punched card reader. Manual entry of data also is possible with a 10-digit keyboard. Four digit resolution both axes, plotting speed 50 points/min. for punched cards, 80 points/min. for perforated tape. Plot accuracy better than 0.15% of full scale. Price, \$8785.

The DY-6575 operates from binary-coded decimal or binary tapes (as specified). Computer time in preparing tapes is saved by recording tapes at normal writing speed and plotting at 1/25 of this speed. Smooth, continuous curves are produced at 4 in/sec with accuracy of 0.2%. Automatic plotting, automatic search simplifies operation. 15" x 10" standard plot, 30" x 30" optional. Price, \$29,450.

Input Scanners

With Dymec Input Scanners multiple signals may be measured with one measuring instrument or system. All scan-

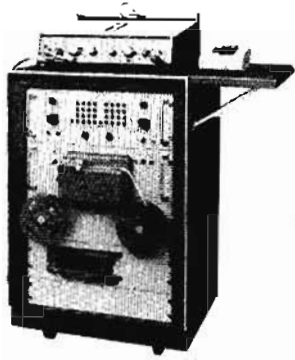

DY-6242



DY-2911



DY-2211B

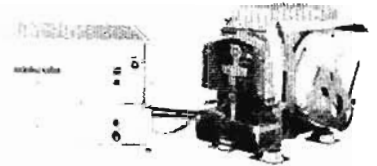

DY-2545

ners can be operated in continuous-scan, single-scan and single-step operating modes, with manual or remote control.

Model DY-2900A scans up to 50 1-wire or 25 2-wire inputs, upper limit selectable at front panel. Channel being measured is indicated by in-line readout and 10-line contact closure output. Price, \$950.

Model DY-2901 scans 25 3-wire inputs and programs all functions of associated system. DY-2902, 3, 4 Slave Scanners may be used to expand capacity to 100 channels. Push-button selection of channels to be scanned. Pinboard inside scanner programs system function and measurement delay for each input channel. Prices, DY-2901, \$1950. DY-2902, 3, 4 (25 channels each), \$1750 each.

Model DY-2911 is a guarded crossbar scanner for rejection of common mode noise, scans 600 1-wire, 300 2-wire, 200 3-wire or 100 6-wire inputs. Lower and upper scan limits selectable at front panel, with random access to any channel. Monitored channel indicated by in-line display and 4-2-2-1 BCD output. Price, \$4650.

Signal Conditioning Devices

Signal conditioners translate the analog signal to a form acceptable by the analog to digital converter. Included are DY-2411A Guarded Data Amplifier (Page 103), and DY-2410A AC/Ohms Converter (Page 103). Both fully programmable, compatible with DY-2401A Integrating Digital Voltmeter (Page 103).

Analog to Digital Converters

Include voltage-to-frequency converters and integrating digital voltmeter. The programmable, floated and guarded DY-2401A Integrating Digital Voltmeter (Page 103) permits accurate low-level voltage measurements even in the presence of severe common mode noise.

Voltage-to-Frequency Converters

Dymec V-F Converters permit voltages to be measured with an electronic counter by converting the signal to a proportional pulse rate. The counter reads the average value of the signal over the sample period, thereby minimizing effects of noise superimposed on the signal. Converter-counter combination may also be used to integrate analog signals over extended periods.

Model DY-2210 accepts dc inputs with full-scale ranges of 1, 10, 100 and 1000 v, for full scale output of 10 kc. 0.1 v range optional. Polarity sensed automatically. Price, \$650. (Cabinet version, \$660.)

Models DY-2211A and B accept dc inputs and offer higher accuracy than the DY-2210. Full scale output of 10 kc

(2211A) or 100 kc (2211B). Both have 1 v full scale input, with ranges up to 1000 v and a 0.1 v range optional. Polarity sensed automatically. Price, \$1250.

Model DY-5207-1 accepts both dc inputs and ac inputs up to 100 kc. Ranges are 0.1 to 1000 v for dc and 1 to 1000 v for ac. Full scale output is 10 kc. Input range and ac/dc operation may be selected manually or by external contact closures. Polarity sensed and indicated automatically. Price, \$1850.

Output Couplers

Dymec Output Couplers transfer and translate data from digital voltmeters, counters and digital clocks to digital recording devices and comparators. Standard input is 4-2-2-1 BCD, others available.

DY-2526 Coupler couples digital voltmeters or electronic counters to IBM 526 Card Punch. Standard model accepts 10 input digits in BCD form, data storage permits high-speed operation. Solid-state. Price on request.

DY-2545 Coupler operates with Teletype BRPE 11 Tape Punch, records at 110 characters/sec. Standard model accepts 10 input digits from digital voltmeter or counter, produces IBM 8-level code. All solid state, features data storage for high-speed operation. Price, including tape punch, \$3900.

DY-2530 Register transfers data from electronic counters, digital voltmeters to parallel-entry card punches, digital comparators and displays. Prices, \$770 to \$1510.

DY-2540 Coupler operates with serial-entry tape punches, card punches, typewriters, Flexowriters. Up to 25 input characters standard, to 50 optional. Max. recording speed, 20 characters/sec. Price, typically, \$1200 to \$2500.

Auxiliary Equipment

DY-2508A Digital Clock supplies time-of-day information to data logging systems or programs external equipment. 24-hour in-line display with 1 sec resolution, also provided as electrical output. Code outputs available: staircase voltage (for the hp 560A Digital Recorder); decimal (10-line) contact closures; binary-coded decimal (4-line) contact closures in 4-2-2-1 or 8-4-2-1 code. Price depends on output code and time reference selected, typically about \$1850.

DY-2532A Digital Comparator can be used in conjunction with DY-2530 Register to compare output of counter or digital voltmeter digit-for-digit against preset upper and lower limits. Limits up to six digits preselected manually. Provides, Hi, Go, or Lo lamp indications and contact-closure outputs. Mounts either in DY-2530 front panel opening or in 19" rack. Price, \$550.

Data subject to change without notice.

MOSELEY AUTOGRAF[®] X-Y, STRIP-CHART RECORDERS, ACCESSORIES

F. L. Moseley Co. offers a complete line of x-y and strip-chart recorders, program controllers, servo voltmeters, digital translators, analog converters and accessories. Data plotted in cartesian coordinate form on graph paper is used today in almost every field of science and industry, and Moseley was a pioneer and today is a leading manufacturer of high accuracy servo driven x-y recorders and strip-chart recorders. Accessories available from Moseley include magnetic and optical line followers, ac/dc and logarithmic converters, character printers and keyboards, all of which greatly increase the flexibility and application of the basic instruments. A complete catalog of instruments is available by writing F. L. Moseley Co., 409 No. Fair Oaks, Pasadena, Calif.

Model 135, 136 Series Recorders

Today's most compact, lightweight, 8½" x 11" x-y recorder, this basic instrument may be used on a bench, rack mounted or carried anywhere. Sixteen calibrated dc input voltage ranges (each axis), 0.5 mv to 50 v/div. Half-second full scale recording speed. Zener reference supply, vacuum paper hold-down, built-in time base on x-axis. Accuracy better than 0.2% of full scale. Model 135, Single-Pen X-Y Recorder, \$1650; simplified Model 135C, \$1190; Model 136, Two-Pen X-Y₁, Y₂ Recorder, \$2650.

Model 2D Series X-Y Recorders

These 11" x 17" X-Y recorders provide 16 dc input ranges, 0.5 mv to 50 v/div. Eight ac input ranges, 0.1 to 20 v/div. Built-in time base on x-axis. Accuracy better than 0.2% of full scale. Zener reference, vacuum paper hold-down. Bench mounting Model 2D, or rack mounting 2DR, \$2450. Without ac ranges, Model 2D-2, or 2DR-2, \$2050. Designed for use with ± 100 v dc computer reference (without ac ranges or time base) Model 2D-3, 2DR-3, \$2050. Simplified Models 2D-4 and 2DR-4, \$1490.

Optional Roll Chart Accessories for Model 2D Series Recorders

Non-rack mounted instruments may be equipped with easily attached accessories allowing use of continuous chart rolls. Type Q-1, Q-2 Hand Crank or Pull Through-Tear Off Roll Chart Accessory, \$85. Type Q-3 Variable Speed Motor Drive Roll Chart Accessory, \$650. Type Q4 Automatic Chart Advance, \$1,000.

Model 2D-5 Transport Delay Simulator

For simulating laboratory or process time delay, the Model 2D-5 combines a Model 2D Series Recorder with roll chart accessory and Type F-3 Line Follower on a second recorder arm. Records, then reads out the data; dc output control voltage is proportional to the y-coordinate. Adjustable delay time from 4 sec to 7 min, \$5900. Also available, Model 685, 5" active paper width, delay time from 4 sec to 2.9 hours, \$1780.

Model 2FR Two-Pen X-Y₁Y₂ Recorder

This instrument plots two dc input signals against a third signal in cartesian coordinates on 11" x 17" graph paper. Ten ranges, 0.5 mv to 50 v/div. Zener reference, vacuum paper hold-down, built-in time base, \$3575.

Model 6S Automatic Chart Advance

Rack mount Model 6S X-Y Recorder has a capacity of 120 10" x 10" charts on a standard roll. The new chart is automatically positioned when desired. Used charts may be stored internally or torn off. Sixteen input ranges, zener reference supply vacuum hold-down, internal time base, \$3150.

Model 7 X-Y Recorder

Model 7 provides a large 30" x 30" recording area, ideal as a plotting table. Designed for table top, console or vertical wall mounting. Modular construction permits rapid change of operating mode to supply time base, ac input or logarithmic conversion capabilities. 13 voltage ranges, 30 mv to 300 v full scale, \$6500.

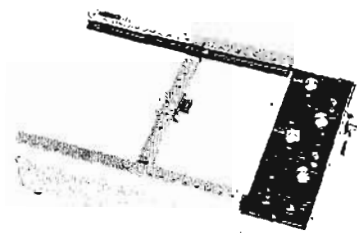

Model 135

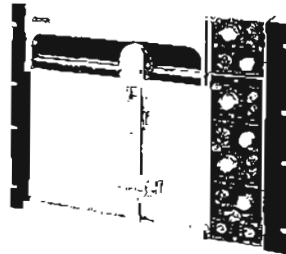

Model 136

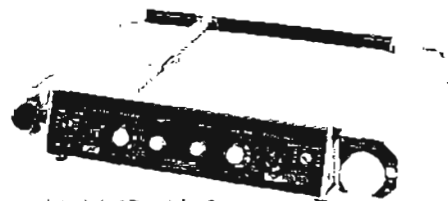

Model 2D with Q-3

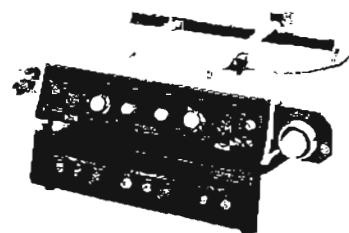

Model 2D-5

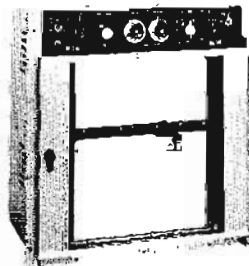

Model 6S



Model 7

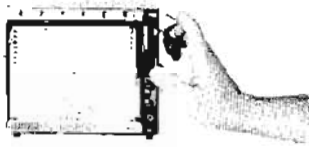

Model 680

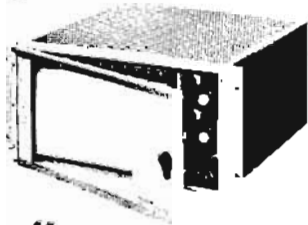

Model 83

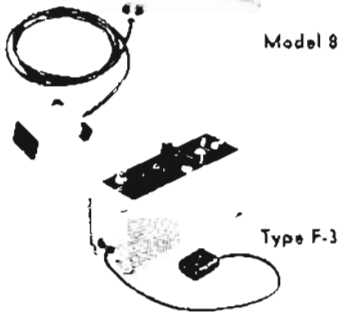

Type F-3



Model 60D

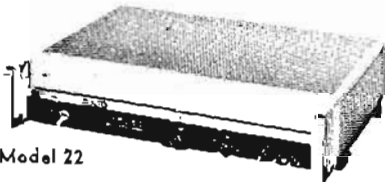

Model 22



Type 101



Character Printer

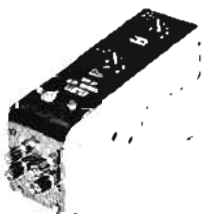

Type A-1

Model 680 Series 6" Strip-Chart Recorders

These compact, modular, solid state, general purpose recorders feature 10 ranges (5 mv to 100 v full scale), zener reference supply, 8 chart speeds, 0.5 sec balance time, 0.2% full scale accuracy, rack or bench mount. Model 680, \$750. Other recorders in the series include Model 681, dual speed, single range, \$625; Model 682, thermocouple operated, \$675; Model 683, current measurement, \$625; Model 680, dc powered, \$975, and Model 685 Transport Delay (see Model 2D-5), \$1780.

Model 83 Two-Pen Strip-Chart Recorder

This two-pen 10" strip-chart recorder offers 15 calibrated ranges, 0.5 mv to 20 v/div.; vernier control. Instant selection of 6 chart speeds, 2, 4, 6, 8, 15 and 60 in/min. 1/4 second full-scale pen response 120-foot chart rolls, local or remote chart and pen controls, \$3450 Model 80A, single pen version, \$2495.

Type F-3 Optical Line Follower

The Type F-3 makes possible optical tracking of almost any high contrast line. Allows pre-recorded curves to 120 feet to be read out from Model 2D, 80A or 680 Recorders. DC output voltage proportional to y-coordinate is available for process or machine control. Follows slopes to 85°, built-in alarm circuit. \$795, plus \$50 installation charge on 2D, \$150 installation charge on 80A. Provided (without error alarm) on 680 Recorders on special order.

Model 60D Logarithmic Converter

This instrument, rack or bench mounted, converts dc or ac to dc proportional to the logarithm of the positive peak amplitude of the input voltage. Better than 60 db dynamic range. 20 to 20,000 cps frequency range. Operating speed 20 db/sec. Output 5, 10 or 20 db/in ± 0.5 db accuracy, \$575.

Model 22 DC Voltmeter

This high accuracy, servo operated voltmeter offers a 14" mirror-backed linear scale, 11 ranges, 3 mv to 300 v full scale. Selectable zero left or zero center. Zener reference, all solid state, \$595.

Type 101 Waveform Translator

Permits plotting of repetitive oscilloscope traces on x-y recorders, automatic or manual sweep, 1 cps to 20 kc, \$575.

Character Printers, Keyboards

Type D-1B individually identifies data points. Three 2-character plungers, solenoid operated. Available as a field kit, \$160. Type D-2 employs six-character print wheel for sequential plotting, \$525. Keyboard for entry of digital data to recorders. Model 40D, \$975.

Type A-1 Dual Channel AC-to-DC Converter

Permits plotting of ac signals, 20 to 200 kc, on dc recorders. Eight ranges each channel, 0.1 v/div to 20 v/div. Accuracy 0.5% to 20 kc, 1% to 50 kc, 2% to 100 kc, \$585.

Data subject to change without notice.

HEWLETT-PACKARD MODULAR ENCLOSURE SYSTEM

The Hewlett-Packard modular enclosure system provides a complete solution to instrument packaging and mounting problems. The system, initiated in 1961, is in accord with the EIA standard rack and panel dimensions, yet each enclosure is equally well suited to bench or field use.

The matching enclosures offer an enviable combination of economy, strength and appearance. They are rugged enough to meet many of the stringent military requirements and are designed to withstand severe shock, vibration and heavy loading. In addition, the larger enclosures are grooved to accommodate gaskets for rf shielding or splash proofing. Attention also has been given to the exterior, resulting in a rich, professional appearance which enhances the value of the instrument.

Two Types of Instruments

Basically instruments enclosed in the modular system fall into two classes:

1. Those units which, by reason of control panel area, volume and/or heat dissipation, require the full EIA rack width. This class of instruments mounts directly in racks with the two brackets and filler-strip included with the instrument; or, if preferred, the feet and tilt stand furnished may be attached for bench use. Accessory panel covers are available for these instruments to protect them when they are transported.
2. Those units which demand a greater height-to-width ratio than the first class, but do not need the full rack

width. These instruments are standardized at $\frac{1}{2}$ or $\frac{1}{3}$ the width of the full module. Because of their size they are easily portable and can readily be used in the field, as well as on the bench. In addition, adapter frames are available to mount these units in the standard EIA racks. The *hp* 1051A, 1052A Combining Cases can also be used with up to twelve sub-module instruments for a multi-instrument package that is both portable and easily rack mounted with the hardware provided. Both combining cases and rack adapter frames use blank panels to fill areas not used by instruments and accept $\frac{1}{3}$ -width drawers for convenient storage of leads, probes, etc. Model 1052A Combining Cases also accept cooling kits to maintain proper ambient temperature. Control panel covers convert the combining cases and full width cabinets to carrying cases.

Characteristic of both classes of modular instruments are the plug-in components that facilitate their maintenance. Top and bottom covers, as well as side panels, are removable to provide access to all adjustments and test points within the instruments.

Specifications

hp 1051A Combining Case (see Figure 3)

Dimensions: $16\frac{3}{4}$ " wide, $7\frac{1}{4}$ " high, $11\frac{1}{4}$ " inside depth, hardware furnished for conversion to 7" by 19" rack mount.



Figure 1. Full rack width cabinets stack one atop the other.

Figure 2. Standard configurations include cabinets one-third and one-half full rack width.

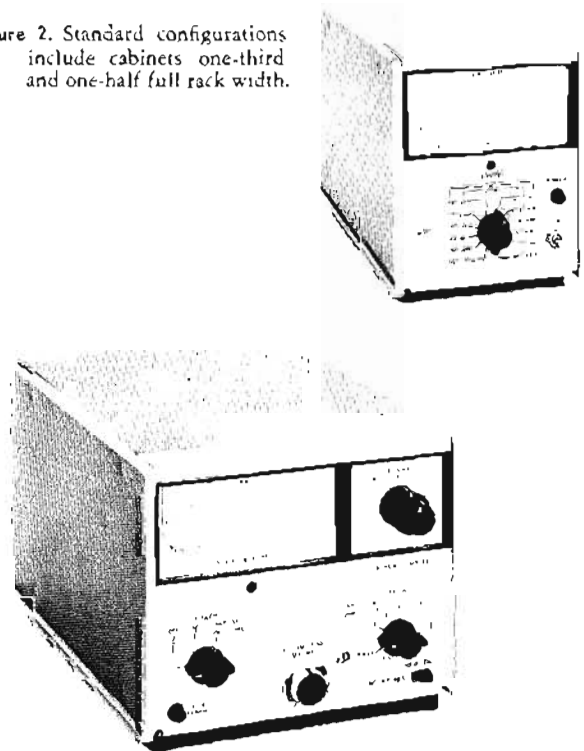

NEW IN THIS CATALOG

Weight: Net 10 lbs. Shipping 19 lbs.
Price: \$78.

Ⓜ 1052A Combining Case (not shown)
Dimensions: 16 $\frac{3}{4}$ " wide, 7 $\frac{1}{4}$ " high, 16 $\frac{3}{8}$ " inside depth,
hardware furnished for conversion to 7" by 19" rack
mount.

Weight: Net 12 lbs. Shipping 27 lbs.
Price: \$82.

Ⓜ Rack Adapter Frame (see Figure 4)
hp 5060-0797: adapter to rack mount 6", 3", or 1 $\frac{1}{2}$ "
high, third width instruments, or 6" high, half width
instruments, or combinations thereof, \$22.50.

Ⓜ Modular Enclosure Accessories (see Figure 7)

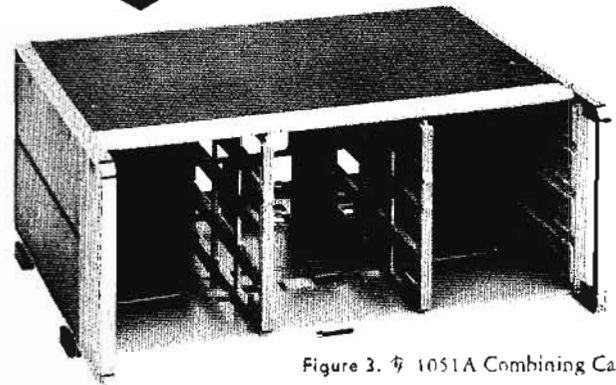

Figure 3. Ⓜ 1051A Combining Case.



Figure 5. Instrument covers quickly convert full width cabinets to easily carried portable units.

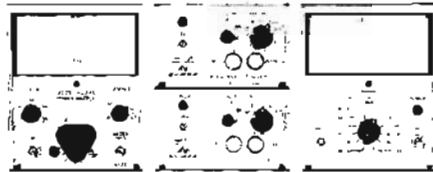

Figure 4. Here one hp instrument, one H Lab instrument and two Dymec instruments are mounted in an hp rack adapter frame.

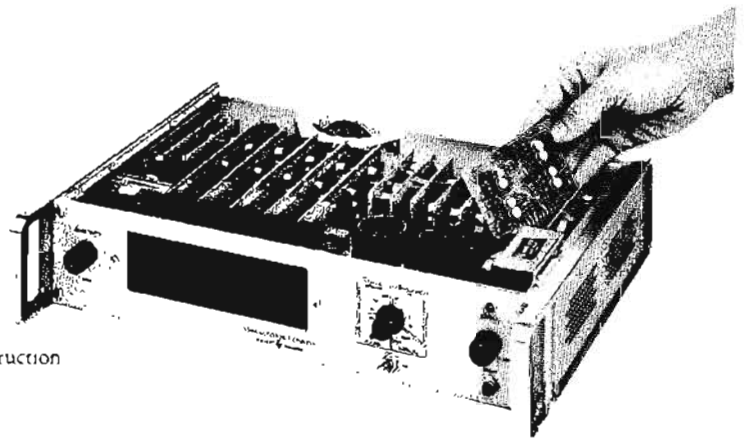
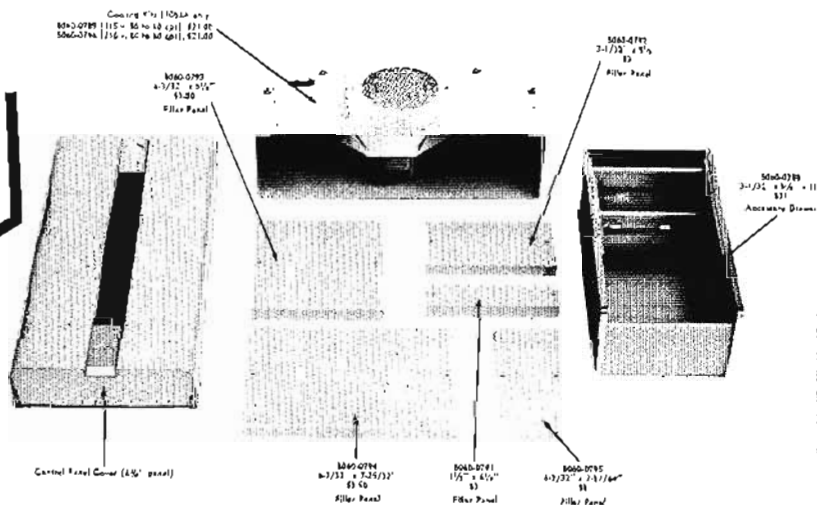

Figure 6. Modular plug-in construction permits easy routine maintenance.

NEW IN THIS CATALOG



Stock Number	EIA Panel Height	Price
5060-0826	3 $\frac{3}{8}$ "	\$22.50
5060-0827	5"	23.00
5060-0828*	6 $\frac{3}{4}$ "	23.00
5060-0829	8 $\frac{1}{2}$ "	23.50
5060-0830	10 $\frac{1}{4}$ "	24.00
5060-0831	12"	24.00

*Also fits Ⓜ 1051A and 1052A.

Data subject to change without notice.

Figure 7. Modular enclosure accessories.

SERVICE INFORMATION

Hewlett-Packard's obligation to provide a reliable instrument for you begins while the instrument is being designed and manufactured, and it continues for as long as you own that instrument. Over the years, Hewlett-Packard has carefully built a service concept second-to-none for providing round-the-world assistance to instrument users. We expect and want to provide those services which will help you keep all of your Hewlett-Packard instruments performing faithfully.

Who to contact

1. Hewlett-Packard engineering representatives are located throughout North America and in major cities around the world. For information, replacement parts, and repair and calibration services for your Hewlett-Packard instruments, please contact the representative nearest you. He is listed on the inside back cover of this catalog.
2. Although your nearby Hewlett-Packard representative offers immediate attention to your needs, you are always welcome to contact the factory:

Customer Service
Hewlett-Packard Company
395 Page Mill Road
Palo Alto, California
TELEPHONE: (Area Code 415) 326-3950
TWX: 415-492-9363
TELEX: 03-3811
CABLE: HEWPACK

What services are available

Training

Hewlett-Packard offers both field service training and factory service training (without charge) for personnel engaged in instrument maintenance. Field service training seminars are arranged by your Hewlett-Packard engineering representative and may be held at his office or at your company location. Factory service training seminars are held at Palo Alto, California; your only cost is for transportation, lodging and meals. Your representative has full information on these seminars.

Publications

In addition to the publications described on page 22 of this catalog, two additional publications are designed specifically to help you with maintenance and service work on your Hewlett-Packard instruments.

Bench Briefs, Customer Service newsletter, published periodically, covering such subjects as new modifications, service shortcuts and other data that will help keep instruments in good operating order. *Bench Briefs* is sent by mail, without charge, to persons directly concerned with repair and maintenance of instruments. Just ask your Hewlett-Packard representative.

Operating and Service Manuals, supplied with each new Hewlett-Packard instrument. Extra copies are available at a nominal charge, usually \$2.50 to \$5.00 each. They may be ordered from your representative or from Customer Service in Palo Alto.

Parts Services

When you need a replacement part, you generally want it fast! That's why Hewlett-Packard engineering representatives maintain Field Service Centers to supplement the Customer Service parts depot at the factory. Both your nearby Field Service Center and Customer Service stand ready to rush parts for your instruments, and orders are usually filled the same day as received.

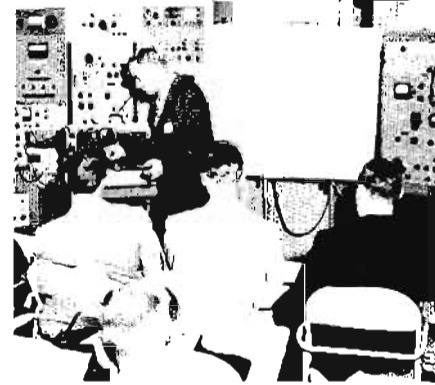

Each year, thousands of Hewlett-Packard equipment users attend Hewlett-Packard Field Service Seminars.

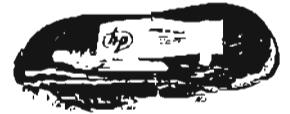

These items make up an isolated service kit for the Hewlett-Packard 410B Vacuum Tube Voltmeter.

Field Service Centers are well equipped to supplement your maintenance activities.



When ordering a replacement part, please specify the following information (see the Operating and Service Manual's "Table of Replaceable Parts") to insure your getting the right part in the shortest possible time.

1. Instrument model number and complete serial number.
2. Hewlett-Packard stock number for the part.
3. The part's circuit reference designator (R3, C7, etc.).
4. A description of the part.

(If for some reason the stock number and circuit reference designator for the desired part are unknown, please include the instrument model and serial numbers — and a complete description of the part, its function and its location within the instrument.)

All replacement parts are carefully packaged to protect the part and prevent shipping or storage damage. These parts can be packaged in rugged military type containers, however, and your representative will be happy to discuss this service with you.

Several types of parts kits are available to assure continuous operation from your instruments when they are being used in an isolated area, or where loss of instrument use would be extremely critical (on a production line, for instance). "Field Repair," "Running Spares," and "Isolated Service" Kits offer varying degrees of completeness, and you can pick the kit that most nearly satisfies your requirements. In addition to spare parts kits, modification kits are available to change the original characteristics or specifications of certain Hewlett-Packard instruments. If you have a requirement for either type of kit, please contact your representative.

Instrument services

Your Hewlett-Packard instruments may be sent to your nearest Field Service Center or to the factory for repair. Complete instructions should be accompanied by a purchase order or other "authorization to proceed." Your instructions should

include "symptoms" if the instrument is not operating properly. Information also should include the address to which the instrument is to be returned and the addresses to use for correspondence and billing purposes. Repair charges are derived from labor plus materials, and charges are the same in the field as at the factory. Repair work is guaranteed, subject to the terms of the standard Hewlett-Packard warranty. Quotations on repair costs can be made before repair is undertaken.

Instrument modification is sometimes made to satisfy special requirements or to up-date instruments that have been in the field for many years. You can easily perform most of these modifications yourself, and modification kits are available for many of them. Or you may request that modifications be made at your Field Service Center or at the factory. New modifications are announced in the Customer Service newsletter, *Bench Briefs*.

Instrument overhaul is possible on older instruments that have been in operation a number of years. If a particular model is no longer manufactured, it can be put in a condition equivalent to that when it was originally purchased. In many cases, you can perform an overhaul yourself, and many representatives also offer an instrument overhaul service. Any Hewlett-Packard instrument can be overhauled at the factory.

The *Operating and Service Manual* for each instrument provides the information required for field recalibration of the instrument. However, your representative will arrange for prompt recalibration of your instrument if it is not convenient for you to undertake the task yourself.

Special "Standards Calibration" services are available in some areas of the United States. In these cases, a report is made describing the measurement conditions, the measurements made and accuracy and, where applicable, traceability to the National Bureau of Standards.

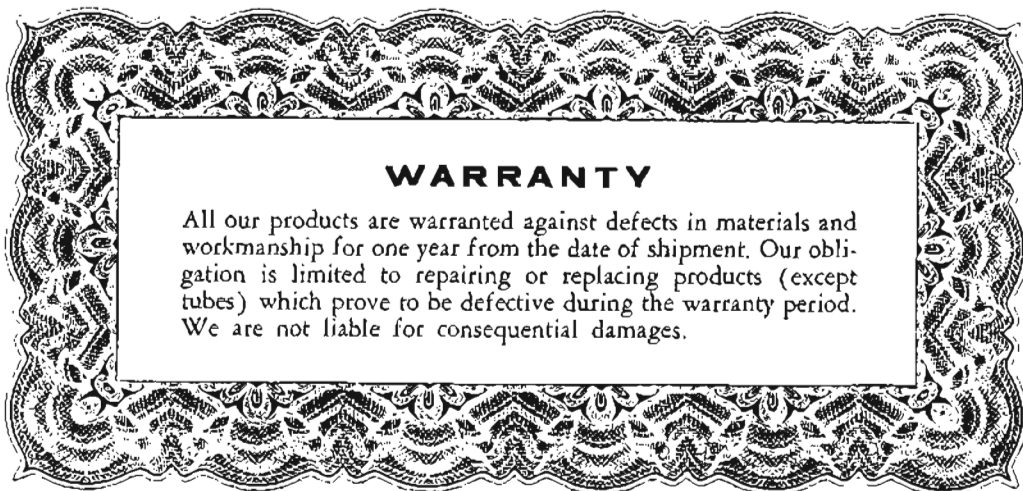

USEFUL INFORMATION AVAILABLE TO YOU ON REQUEST

FROM HEWLETT-PACKARD

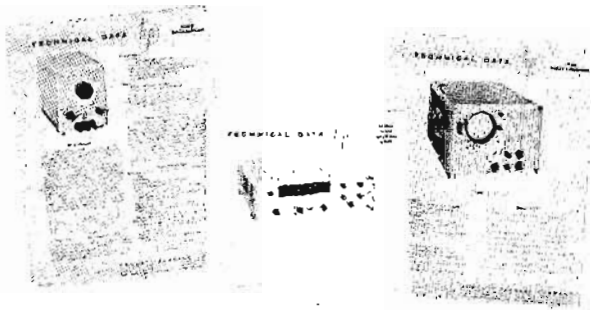

TECHNICAL DATA SHEETS. On standard hp instruments, these sheets contain complete information on instruments described in this catalog. For complete published data on any particular instrument, and for up-to-date data on instruments developed after publication of this catalog, **TECHNICAL DATA SHEETS** are useful. They may be obtained either from your local hp engineering representative, or by writing hp direct.

APPLICATION NOTES. A series of **APPLICATION NOTES** describe measuring methods, techniques, efficient test instrument application. Many **APPLICATION NOTES** are referenced in this catalog; write for an index of all **APPLICATION NOTES** available, or for titles you desire; watch new literature announcements and hp advertising for announcements of other titles.



HEWLETT-PACKARD JOURNAL. Published monthly by the hp R & D laboratories, the Hewlett-Packard **JOURNAL** is devoted to detailed, academic discussion of new measuring approaches, most productive methods of employing test instrumentation, latest instrumentation for complex as well as routine measurements. For your free subscription simply write on your letterhead to Hewlett-Packard **JOURNAL**, Hewlett-Packard Company, 1501 Page Mill Road, Palo Alto, California.

From HEWLETT-PACKARD Divisions and Affiliates

DATA SHEETS, CATALOGS, APPLICATION NOTES. Each of the Hewlett-Packard divisions and affiliates, whose products are briefly described on Pages 9 through 17, publish detailed data sheets and catalog material describing their products. These may be obtained from your nearest Hewlett-Packard sales engineering representative, or by writing directly to Dymec, Boonton Radio Company, F. L. Moseley Company, or Sanborn Company.

SANBORN RIGHT ANGLE. Published periodically by the Sanborn Company as a source of helpful technical information for users and potential users of Sanborn Oscillographic Recording Equipment. For sample copies or a free subscription write directly to the Industrial Division, Sanborn Company, Waltham 54, Massachusetts.

THE BRC NOTEBOOK. Published several times a year by Boonton Radio Company, **THE BRC NOTEBOOK** provides detailed technical information on operation and application of Boonton products. Copies are available by writing directly to Boonton Radio Company, P.O. Box 390, Boonton, New Jersey.

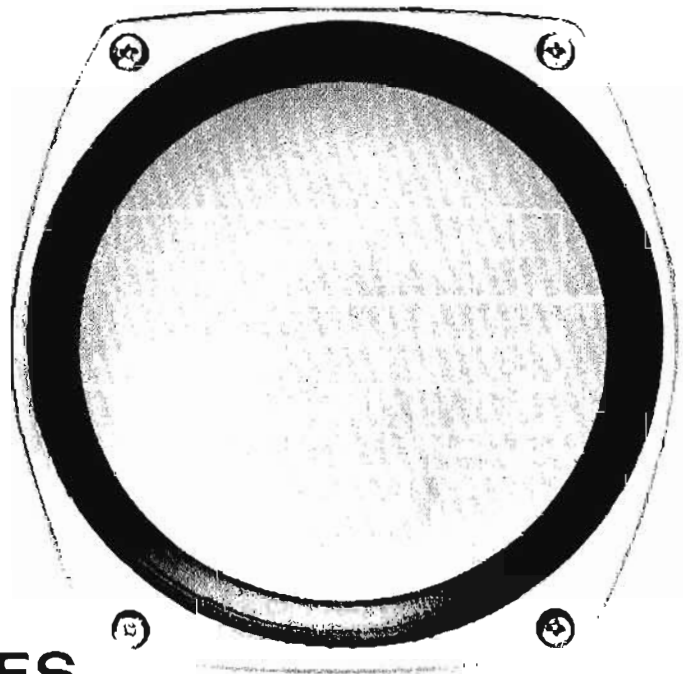

OSCILLOSCOPES

Pulse Generators

- Low Frequency Scopes*
- High Frequency Scopes*
- Sampling Scopes*
- Oscilloscope Cameras*
- Oscilloscope Accessories*
- Pulse Generators*
- Square Wave Generators*
- Digital Delay Generators*

OSCILLOSCOPES

The cathode ray oscilloscope is an extremely fast x-y plotter which plots an input signal vs. another signal or vs. time. The "stylus" is a luminous spot which moves over the display area in response to the input voltages. In the usual scope application, the x-axis input is an internally generated linear ramp voltage which moves the spot uniformly from left to right across the display screen. The voltage being examined is applied to the y-axis input, moving the spot up or down in accordance with its instantaneous value. The spot then traces a curve which shows how the input voltage varies as a function of time.

When the signal being observed is repetitive at a fast enough rate, the display appears as a steady line. The cathode ray oscilloscope thus is a means of visualizing time-varying voltages. As such, it has become a universal tool in all kinds of electronic investigations. In addition to voltages, a scope can present visual representations of a wide variety of dynamic phenomena by the use of transducers for converting current, strain, acceleration, pressure and other physical quantities into voltages.

Stemming from the straightforward ability of an oscilloscope to display signals in a two-dimensional plane, a broad variety of instruments with many special features has been developed by Hewlett-Packard. Some of the fundamental operations of these "real time" cathode ray oscilloscopes are described below. (Sampling oscilloscopes are described on page 44.)

The Cathode Ray Tube

The cathode ray tube (CRT) is the heart of the cathode ray oscilloscope, with the rest of the instrument consisting of circuitry for operating the CRT. As is commonly known, this tube has an electron gun at one end and a phosphor display screen at the other end. The gun has a thermionic cathode, various accelerating electrodes for directing emitted electrons toward the display screen, and a focusing electrode. The resulting narrow beam of electrons from the gun strikes the phosphor in a small spot with enough energy to cause fluorescence.

On leaving the gun, the electron stream passes between each of two pairs of deflection electrodes. Voltages applied to these electrodes bend the beam, voltages on one pair of electrodes moving the beam up and down, and voltages on the other pair moving it from side

to side. These movements are independent of each other so that the spot may be positioned anywhere on the phosphor screen by appropriate voltage inputs.

The accuracy with which the viewed waveform corresponds to the deflection voltages depends in large measure on the performance of the cathode ray tube. Careful design of the electrodes and the precision manufacturing techniques of the Hewlett-Packard cathode ray tube facility insure that the beam moves linearly with respect to the deflection voltages. Hewlett-Packard's precision CRT's make it possible to measure accurately the input voltage amplitude at any point on the waveform by measurement of the amount of deflection of the fluorescent spot.

Internal Graticule

The amount of spot deflection, and thus the input voltage amplitude, is gaged by a rectangular graticule placed on the display area. A significant contribution to precision oscillography was made by Hewlett-Packard with the introduction of the internal graticule tube. In these tubes the graticule of fine, black lines is placed in the same plane as the phosphor. This avoids errors caused by the parallax which otherwise exists when the graticule is external to the tube, separated from the phosphor by the thickness of the glass face-plate.

CRT photography is improved by the internal graticule tube. With the proper techniques, described on page 52, the trace shows white, the graticule shows black, while the background is an intermediate gray. This results in maximum contrast between trace and graticule and at the same time obtains an increase in photographic speed.

Another feature of Hewlett-Packard's internal graticule tube is that the outer surface of the face-plate is etched slightly, thus minimizing glare and bothersome reflections. This face-plate is made of laminated glass, giving superior protection from implosion without the need for an external plastic shield.

CRT Phosphors

The purchaser of an oscilloscope has the option of selecting the phosphor best suited to his primary applications. The various chemical salts used in CRT phosphors have different characteristics affecting the color of fluorescence and its brightness, decay, and speed of response. Unless otherwise specified, most Hewlett-Packard scopes are supplied with the new P31 phosphor. This phos-

phor combines brightness and a spectral response well suited to the eye, with ruggedness and resistance to burning. Phosphor characteristics are discussed in the table on page 26.

The Cathode Ray Oscilloscope

The primary subsystems of a cathode ray oscilloscope are the CRT, the vertical deflection system, the horizontal deflection system and the power supplies. The power supplies include focusing and intensity controls for adjusting the CRT spot.

The horizontal deflection system supplies drive voltages for moving the electron beam horizontally. Since so many measurements are concerned with plotting voltage vs. time, the horizontal deflection system also includes sawtooth waveform generators for sweeping the beam horizontally at a uniform rate, and synchronizing circuits for starting the horizontal sweep at a specific instant with respect to the measured waveform.

The horizontal amplifiers of all Hewlett-Packard scopes may be used separately from the sweep generating circuits for deflecting the horizontal beam in response to external waveforms, a useful technique for making x-y plots.

The vertical deflection system consists of an amplifier chain for amplifying low-level input signals sufficiently to drive the CRT spot. Attenuators are included so that a wide range of input signal amplitudes may be accommodated within the vertical dimension of the display area.

Selecting an Oscilloscope

Choice of an oscilloscope is based largely on considerations of both performance capabilities and versatility. Versatility is greatly enhanced if the scope has plug-in capability, since the scope's performance can be altered by use of the appropriate plug-in. Plug-in capability also enables a scope's performance to be updated as new plug-ins become available. The prospective purchaser should decide first of all whether his applications are broad enough to require plug-in versatility.

Bandwidth and sensitivity of the vertical amplifiers are the primary characteristics which describe an oscilloscope's performance capabilities. Wide bandwidth is obtained at the expense of more complicated circuitry and more expensive cathode ray tubes. High sensitivity requires more amplifier stages and

added refinements for minimizing dc drift and noise.

Detailed discussions of the various Hewlett-Packard oscilloscopes are grouped in later sections according to the capabilities of the vertical amplifier. These discussions are divided as follows: 1) low-frequency scopes (to 500 kc), useful for the majority of industrial and laboratory applications (page 27); 2) high-frequency scopes (to 50 mc) having the additional features required for high frequency or fast pulse work (page 34); and 3) sampling oscilloscopes, which extend scope measurements to frequencies of 1 gc and above and to pulses with rise times measured in nanoseconds while still retaining a large, bright display, high sensitivity and a high input impedance (page 44).

The reader is referred to these sections for detailed discussions of scope characteristics. Certain other features, common to most Hewlett-Packard scopes, are described here.

Features of the Vertical Deflection System

The amplifiers in Hewlett-Packard oscilloscopes are stable enough to permit voltage measurements with confidence to at least $\pm 3\%$ accuracy. To verify amplifier accuracy, all Hewlett-Packard scopes have built-in calibrators which supply precisely controlled signals for use as calibrating test signals.

DC coupling, included on all Hewlett-Packard scopes, preserves the waveform of slowly varying signals and also permits a dc reference line to be established on the display, facilitating precise amplitude measurements. DC coupling is not desirable, though, when a small ac component on a relatively large dc voltage is to be examined. All *hp* scopes (except the Model 185B) have switches for inserting decoupling capacitors into the signal line when dc coupling is not desired.

A widely used option in oscilloscope vertical deflection systems is the provision for two signal channels. Dual channel operation is obtained most conveniently by electronic switching between signal channels, resulting in alternate displays of the two signals. Switching may occur between sweeps so that the waveform of one channel is displayed during one sweep, and the other waveform is displayed on the next sweep; or switching may occur rapidly (40 kc to 1 mc) for displaying samples of both channels during one sweep. This latter method, frequently referred

to as "chopped" presentation, is most often used for low frequency waveforms which otherwise would flicker with alternate sweep presentation.

Dual channel presentation enables comparison studies of two signals, such as phase measurements or studies of an amplifier's output signal vs. its input. The two inputs of dual channel oscilloscopes have separate preamps and attenuators for independent adjustment of the amplitudes of the two signals.

Horizontal Section

Triggered sweeps, used in all Hewlett-Packard oscilloscopes, cycle only in response to a trigger signal, otherwise remaining in a "locked out" state. This is in contrast to the so-called recurrent sweep which operates continuously and is synchronized by varying its repetition rate until it locks in on some submultiple frequency of the triggering waveform.

The advantage of the triggered sweep is that sweep duration can be any fraction or multiple of the input waveform period (recurrent sweeps cannot display less than a whole period). The triggered sweep is most useful when only short segments of the input signal need to be examined in detail, the sweep speed being set so that this small portion of the waveform is expanded to occupy the whole trace.

The fastest horizontal sweep should be commensurate with the vertical amplifier response. That is to say, sweep should be fast enough to "spread out" fast moving changes in vertical deflection. Sweep controls on *hp* scopes are designed to indicate sweep speed directly for ease in trace evaluation. All *hp* scopes have easy-to-use synchronizing controls.

The sweep magnifier, a useful feature found on all *hp* oscilloscopes, expands the sweep width. A x5 magnifier, for instance, expands the normal 10-centimeter trace to 50 centimeters. By moving the horizontal positioning control, any part of the expanded sweep may be brought into the viewing area.

Other features of the horizontal deflection system, such as sweep delay, single-sweep operation and the like, are discussed in later sections.

Other Features

The Beam Finder button, a convenience feature found on Hewlett-Packard scopes, simplifies trace centering. Pressing this button reduces the gain of both horizontal and vertical am-

plifiers while simultaneously brightening and defocusing the trace. In this way, the trace is brought on screen, regardless of the settings of the positioning, intensity and sweep trigger controls.

Reliability through conservative design is built into all Hewlett-Packard scopes. Reduction of tube types to a few reliable frame grid tubes and Nuvistors reduces tube failures, the most common source of instrument breakdown. Silicon rectifiers and transistorized regulators in the power supplies result in less power dissipation and few heat problems.

Hewlett-Packard oscilloscopes are designed for ease of servicing, with all components readily accessible. In particular, the *hp* Model 175A 50-mc oscilloscope eliminates the many distributed amplifier adjustments found on other high-frequency scopes. Late model scopes use edge-on connectors for ease in removal of entire circuit sections for replacement or repair.

The newer *hp* scopes are packaged in the *hp* modular cabinets. These instruments can be stacked on the bench with other *hp* instruments or quickly converted to rack mounting. A tilting bail raises either end for easier viewing on the bench.

Accessories

Accessories for Hewlett-Packard oscilloscopes include probes, viewing hoods and testmobiles (see pages 54, 55). A separate group of accessories is available for making maximum use of the capabilities of the Model 185B Sampling Oscilloscope (see pages 50, 51).

Voltage probes are of the slim, penholder style with pushbutton jaws for easy connection to small contact points in tight places. These probes include one for straight-through connection from circuit to scope and compensated voltage-divider probes for high-impedance input.

Current probes make examination of ac currents as easy as voltage measurements. These probes clamp around the conductor or small component without disturbing the circuit and convert the current to a voltage for oscilloscope display.

The Models 1115A and 1116A Testmobiles accommodate oscilloscopes and other instruments on an easily-rolled cart. The carts have tilting platforms for easy viewing of the CRT.

Oscilloscope cameras and related techniques are discussed on pages 52 and 53.

PHOSPHOR CHARACTERISTICS, HEWLETT-PACKARD CATHODE RAY TUBES

Phosphor	Trace Color		Low Level Persistence ²	Relative Burn Resistance	Relative Visual Brightness				Use
	Under Excitation	After Glow			2.5 kv Non-Alum.	5 kv Alum ³	10 kv Alum ³	12 kv Alum ³	
P1 ¹	Green	Green	180 msec	100	100	600	3000	3600	Visual observation of medium and fast repetitive signals.
P2	Blue	Yellow	1 sec	150	90	550	2000	2400	Visual display and photographic recording of medium and slow repetitive signals.
P7	Blue-White	Yellow	3 sec	75	50	400	1500	1800	Long persistence makes P7 useful for visual observation of slow transients and slow repetitive signals.
P11	Blue	Blue	20 msec	75	20	200	800	950	Best for photographic recordings of fast waveforms and transients, poor for visual work.
P31	Blue-Green	Light Green	500 msec	250	110	1300	5000	6000	Best general purpose phosphor for visual and photographic use on all waveforms, most resistant to burning.

¹P1 phosphor will not fluoresce under ultra violet excitation. Not available with internal graticule.

²Low level persistence is a measure of the time for the after glow to decrease to 0.01% brightness, a level of light intensity which is still visible.

³Aluminized CRT has greater visual brightness and is less susceptible to burning. Typical increase in visual brightness is 2½ times on 5 kv CRT's and 3½ times on 10 kv CRT's.

RACK MOUNT INFORMATION OSCILLOSCOPES AND PULSE GENERATORS

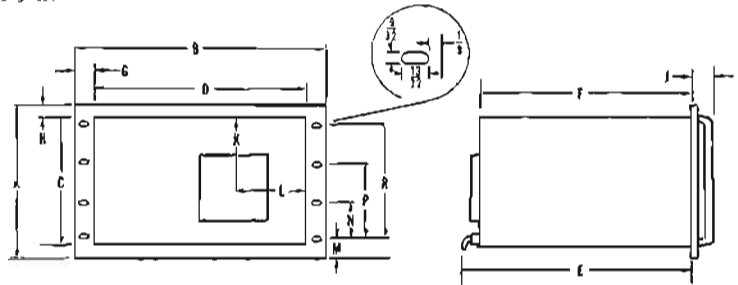

Dimensions in Inches

	120B	122A	130C	140A	160B	170A	175A	185B	214A	215A
A ¹	6-31/32	6-31/32	6-31/32	8-23/32	12-7/32	12-7/32	12-7/32	12-7/32	6-31/32	5-7/32
B ¹	19	19	19	19	19	19	19	19	19	19
C	6-25/32	6½	6-25/32	8-17/32	11-21/32	11-21/32	12-1/32	11-21/32	6-25/32	5-1/32
D	16¾	16¾	16¾	16¾	16-15/16	16-15/16	16¾	16-15/16	16¾	16¾
E	17	19½	17¾	17¾	22¼	22¼	23	22¼	17	17
F	16¾	19	16¾	16¾	20¼	20¼	22¾	20¼	16¾	16¾
G	1½	1½	1½	1½	1-1/16	1-1/16	1½	1-1/16	1½	1½
H	0	¼	0	0	5/16	5/16	0	5/16	0	0
J	2	1¼	2	2	2	2	2	2	2	2
K	—	—	—	4	6⅝	6⅝	7	6⅝	3¼	2⅞
L	—	—	—	9¼	11	11	11½	11	11¾	4¼
M ¹	1-31/64	1-31/64	1-31/64	1-31/64	1-31/64	1-31/64	1-31/64	1-31/64	1-31/64	1-31/64
N ¹	—	—	—	—	3½	3½	3½	3½	—	—
P ¹	—	—	—	—	5¾	5¾	5¾	5¾	—	—
R ¹	4	4	4	5¾	9¼	9¼	9¼	9¼	4	3¼
COOLING										
Type	C	C	C	F. A.	F. A.	F. A.	F. A.	F. A.	F. A.	F. A.
Air In	B	B	B	R	R	R	R	R	R	R
Air Out	S. T. R.	T. R.	S. T. R.	S	S	S	S	S	S	S
CFM ²	25	35	25	60	110	110	90	65	85	15

Abbreviations: C=Convection, F.A.=Forced Air, B=Bottom, R=Rear, S=Sides, T=Top.

¹Conform to EIA standards for rack mounts.

²This is the recommended volume of air, at normal ambient temperature, that should be supplied to the rack mounted instrument for cooling. The following expression may be used as a "rule of thumb" to establish the volume of cooling air required by the entire enclosure:

$Q = 176 \times P$ (kw) where $Q = \text{Cfm}$ (vol. of air); $P(\text{kw}) = \text{kw}$ of input power to the enclosure. Additional air should be supplied if the intake air is not distributed proportionally to each instrument or if it is at a high ambient temperature.

LOW FREQUENCY OSCILLOSCOPES

Oscilloscopes in Hewlett-Packard's low frequency group make accurate voltage and time measurements on a wide variety of waveforms in the sub-sonic, audio, ultrasonic, and low rf ranges. Although many are capable of measurements of signal frequencies up to 500 kc, these instruments are classified arbitrarily as "low frequency" oscilloscopes to distinguish them from the more elaborate "high frequency" scopes that have frequency responses extending into tens of megacycles.

Hewlett-Packard oscilloscopes in the low frequency category are the Models 120B, 122A and 130C. The versatile 140A also may be included here, depending on the plug-ins selected for use with it.

These scopes are intended for analysis of waveforms in which little importance is attached to frequency components beyond 500 kc. The dc amplifiers and long sweep rates are suitable for medical and mechanical studies, as well as for low frequency electrical work. At the same time fast sweep speeds are provided in these instruments for detailed studies of transient phenomena, vibration effects, audio analysis and other higher frequency physical events.

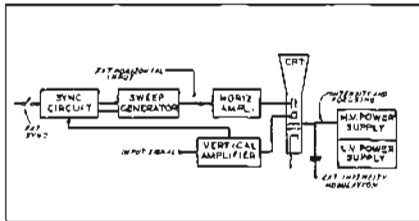

Figure 1. Simplified block diagram of an oscilloscope.

Cathode Ray Tubes

The precision cathode ray tubes in the *hp* low frequency scopes use the phosphors described on page 26 and feature parallax-free internal graticules. The graticules cover a 10 by 10 cm useful display area. A large calibrated display area such as this is especially advantageous for x-y measurements.

The cathode ray tubes of most of these scopes are monoaccelerator types in which all electron acceleration takes place in the gun section. The electron stream is not subjected to any electrostatic fields after leaving the gun section, insuring straight-line travel to the phosphor screen. Accurate deflection factors result and the bright, clear cathode ray trace remains sharply focused throughout the large display area.

Vertical Section

High sensitivity is built into *hp* low-frequency scopes (to 200 $\mu\text{v}/\text{cm}$ in the 130C and to 100 $\mu\text{v}/\text{cm}$ in the 140A plug-in of the 140A scope). High sensitivity enables transducer outputs to be connected directly to the scope, simplifying instrumentation set ups. For instance, dynamic measurements of strain are readily made with the concise instrumentation diagrammed in Figure 2.

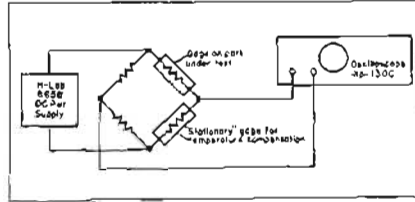

Figure 2. Dynamic strain measurements made with high-sensitivity oscilloscope.

High amplifier gain with minimum drift and noise is obtained in the *hp* scopes by careful circuit design. Large amounts of negative feedback, aided by the use of regulated power supplies, achieves gain stability for measurement accuracy. Excellent dc stability is maintained through the use of balanced amplifiers, regulated dc filament power and conservatively operated components with low coefficients of temperature.

The balanced amplifier design also means that balanced input signals can be connected directly to these scopes. When used in the differential mode, the scope displays the voltage difference between the signals on the two input leads, while canceling "in-phase" (common mode) voltages existing on both leads.

Provision is made for ac coupling in the amplifiers when it is desirable to remove the dc component of a signal.

Horizontal Amplifiers

The amplifiers for horizontal deflection in *hp* low frequency scopes have phase shift characteristics which are matched to the vertical amplifiers up to and beyond 100 kc. In particular, the model 130C features vertical and horizontal amplifiers which have identical characteristics with respect to both phase and sensitivity.

Matched amplifier characteristics enhance the precision of phase measurements in the x-y mode. A typical sine wave phase measurement is diagrammed in Fig. 3. Here, horizontal and vertical amplifier gains are adjusted for equal deflection. The resulting display pattern

is an ellipse whose shape indicates the phase angle between the signals at the scope's input. At one extreme this ellipse becomes a straight line slanting towards the right at 45° (0° phase shift). At the other extreme, it slants to the left at 45° (180° phase shift). Other values of phase shift lie between these extremes; 90° (or 270°) phase shift generates a circle. The phase shift is calculated from measurements of the parameters indicated on the diagram¹. Useful voltage-current phase relationships also can be studied by using an *hp* current probe as one of the input signals (see page 54).

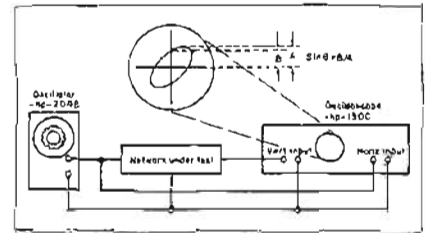

Figure 3. Phase measurement using scope in x-y mode.

Horizontal Sweep

Automatic triggering is selected by a switched position on the trigger level control. This position alters the trigger circuit so that the sweep cycles automatically in the absence of an input signal, at approximately 50 cps. With this feature, a baseline is always present for ease in setting up the scope. The sweep will then trigger on any waveform having sufficient amplitude (1/2 cm of deflection) and having a repetition rate faster than 50 cps.

For more flexible triggering, the trigger level control may be switched out of automatic and positioned so that the scope triggers at any desired point on the input waveform.

These scopes have been designed for "connect-and-read" convenience, as well as having the performance capabilities required for precision measurements. With automatic triggering and direct-reading controls, *hp* low frequency scopes can be operated readily by inexperienced personnel. At the same time, the precision and flexibility required for laboratory use are available.

¹For a direct-reading method of phase shift measurement, the reader is referred to "A Convenient Method for Measuring Phase Shift," *hp* Application Note No. 29.

hp 120B 450 KC OSCILLOSCOPE

Easy-to-Use, General Purpose 450 KC Oscilloscope

Advantages:

Greater accuracy with no parallax, no glare CRT
Beam Finder, automatic triggering simplify operation
Modular cabinet converts quickly from bench to rack
mount
Easy access to circuitry

Uses:

General purpose for lab, production, and systems
View complex waveforms in audio and video devices
Monitor transducer outputs

The hp 120B Oscilloscope offers new features for high accuracy, convenience, ease of operation, and versatility. The no parallax, no-glare cathode ray tube (CRT) and the calibrated sensitivity and sweeps permit more accurate measurements; the beam finder and automatic triggering simplify operation; the modular cabinet is easily converted for rack mounting. Further, the front panel controls are logically arranged, making the 120B easy to operate, even by non-technical personnel.

Automatic triggering provides a clear base line even in the absence of an input signal and eliminates complicated trigger adjustment. If desired, the automatic trigger may be switched out and the trigger level selected manually with a front panel control. A front-panel Beam Finder push button quickly locates an off-screen trace. Controls are color coded and logically arranged for convenient operation.

Specifications

Sweep

Sweep Range: 1 $\mu\text{sec}/\text{cm}$ to at least 0.5 sec/cm . 15 calibrated sweeps, 5 $\mu\text{sec}/\text{cm}$ to 200 ms/cm , accurate to within $\pm 5\%$ (1, 2, 5, 10 . . . sequence); x5 sweep expand. Vernier permits continuous adjustment and extends the 200 ms/cm step to at least 0.5 sec/cm .

Sweep Expand: x5, expands fastest sweep to 1 $\mu\text{sec}/\text{cm}$. Sweep accuracy is $\pm 10\%$.

Automatic Synchronization: *Internal:* From signals 50 cps to 450 kc causing $\frac{1}{2}$ cm vertical deflection, and from line voltage.
External: From signals 50 cps to 450 kc, 1.5 v peak-to-peak, or greater.

Trigger Point: Negative slope of external sync signals, positive or negative slope of vertical deflection signals. Front panel control overrides automatic and sets trigger point from -10 to $+10$ volts.

Vertical Amplifier

Bandwidth: DC coupled; dc to 450 kc; ac coupled: 2 cps to 450 kc.
Sensitivity: 4 steps, 10 mv/cm to 10 v/cm , attenuator accuracy $\pm 3\%$. Vernier permits continuous adjustment and extends 10 v/cm step to at least 100 v/cm .

Internal Calibrator: Accuracy $\pm 2\%$; automatically connected.

Input Impedance: 1 megohm, approximately 50 pf shunt.

Balanced Input: On 10 mv/cm range; input impedance, 2 megohms shunted by approximately 25 pf. Common mode rejection at least 40 db. Common mode signal must not exceed ± 3 volts peak.

Phase Shift: Vertical and horizontal amplifiers have same phase characteristics within $\pm 2^\circ$ to 100 kc when verniers are in CAL.

Horizontal Amplifier

Bandwidth: DC coupled; dc to 300 kc; ac coupled: 2 cps to 300 kc.
Sensitivity: 3 calibrated steps, 0.1 v/cm , 1 v/cm , and 10 v/cm , accurate within $\pm 5\%$. Vernier permits continuous adjustment and extends 10 v/cm step to at least 100 v/cm .

Input Impedance: Approximately 1 megohm, nominal, shunted by 100 pf.

General

Cathode Ray Tube: hp (P31 phosphor) internal graticule, mono-accelerator; 2700-volt accelerating potential. Face plate eliminates glare and reduces hazard of implosion. P2, P7, and P11 phosphors are available.

Internal Graticule: 10 cm x 10 cm marked in cm squares. Major horizontal and vertical axes have 2 mm subdivisions. Eliminates parallax error.

Intensity Modulation: Front panel terminals; +20 volt pulse blanks normal trace.

Dimensions: 16 $\frac{3}{4}$ " wide, 6 $\frac{3}{4}$ " high, 18 $\frac{3}{8}$ " deep overall; hardware furnished for quick conversion to rack mount (7" x 19" panel, 17" deep behind panel).

Weight: Net 32 lbs. Shipping 45 lbs.

Power: 115 or 230 v $\pm 10\%$, 50 to 1000 cps; approximately 95 watts.

Accessories Available: See Pages 54-55.

Price: hp Model 120B. \$475.

Options (no extra charge):

- 02. P2 in lieu of P31 phosphor
- 07. P7 in lieu of P31 phosphor
- 11. P11 in lieu of P31 phosphor

Data subject to change without notice.

NEW IN THIS
CATALOG

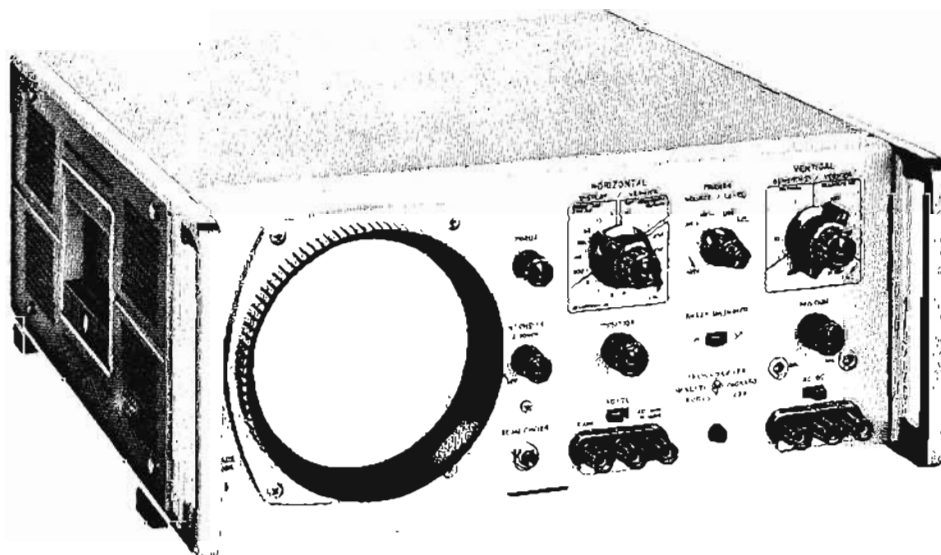

hp 122A, AR DUAL TRACE 200 KC OSCILLOSCOPES

Advantages:

- Internal graticule, glare free CRT
- Twin vertical amplifiers, for simultaneous comparison of signals
- Differential input rejects unwanted signals
- Direct reading calibration, automatic sync
- Simple operation, easily used by non-technical personnel

Models 122A, AR Dual Trace Oscilloscopes provide calibrated dual trace capabilities with highly linear sweeps and are simple to operate even by non-technical personnel.

Accurate phase shift measurements also are easily made. Relative phase shift between vertical and horizontal amplifiers is less than 2° at 100 kc.

The 122A will accept either single-ended or balanced input signals. For balanced input, a front panel switch connects the outputs from both vertical sensitivity switches to one amplifier, so that differential and balanced signals may be examined. Since each attenuator operates independently, signals of differing amplitudes may be studied.

Automatic triggering, which provides a clear baseline in the absence of an input signal, eliminates complicated trigger adjustments and speeds operation. If desired, it may be locked out and the triggering level selected manually with a front panel control. For added convenience, the new hp-developed internal graticule which eliminates parallax is used.

A "times - 5" sweep expander speeds observation and analysis of transients by expanding any 2 cm segment of a trace to 10 cm.

Specifications

Model 122A, AR

Sweep

- Sweep Range:** 15 sweeps, 5 μ sec/cm to 200 ms/cm, calibrated within $\pm 5\%$. Vernier extends the 200 ms/cm step to at least 0.5 sec/cm.
- Synchronization:** Automatic from 50 cps to 250 kc; internally from vertical deflection signals causing 0.5 cm or more deflection; externally from 2.5 volts peak-to-peak or greater; line voltage.
- Trigger Point:** Negative slope of external sync signals, positive or negative slope of vertical deflection signals. Control overrides automatic for setting trigger point between -10 and $+10$ volts.

Vertical Amplifiers

- Bandwidth:** DC coupled; dc to 200 kc. AC coupled; 2 cps to 200 kc.
- Sensitivity:** 4 calibrated steps; 10 mv/cm, 100 mv/cm, 1 v/cm, and 10 v/cm, accurate within $\pm 5\%$. Vernier permits continuous adjustment and extends 10 v/cm step to at least 100 v/cm.
- Internal Calibrator:** Accuracy $\pm 2\%$. Automatically connected.
- Input Impedance:** 1 megohm, approximately 50 pf shunt.
- Phase Shift:** Vertical and horizontal amplifiers have same phase characteristics within $\pm 2^\circ$ to 100 kc when verniers are in CAL.
- Balanced Input:** On 10 mv/cm range on both amplifiers. Input impedance, 2 megohms shunted by approximately 25 pf. Common mode rejection is at least 40 db. Common signal must not exceed ± 3 volts peak.
- Difference Input:** Both input signals may be switched to one channel to give differential input on all vertical sensitivity ranges.
- Vertical Presentation:** A only, B only, B-A, Alternate or Chopped.

Horizontal Amplifier

- Bandwidth:** DC coupled; dc to 200 kc. AC coupled; 2 cps to 200 kc.
- Sensitivity:** 3 calibrated steps; 0.1 v/cm, 1 v/cm, and 10 v/cm, accurate within $\pm 5\%$. Vernier permits continuous adjustment and extends 10 v/cm step to at least 100 v/cm.
- Input Impedance:** 1 megohm, nominal, shunted by approximately 100 pf.

General

- Cathode Ray Tube:** hp mono-accelerator. P31 phosphor normally supplied with internal graticule; P2, P7 and P11 phosphors available. Accelerating potential, 3000 v.
- CRT Plates:** Direct connection to deflection plates via terminals on rear. Sensitivity approximately 20 v/cm.
- Intensity Modulated:** Terminals on rear. $+20$ v pulse will blank trace of normal intensity.
- Dimensions:** Cabinet: $9\frac{3}{4}$ " wide, 15" high, $21\frac{1}{4}$ " deep. Rack Mount: 19" wide, 7" high, $19\frac{1}{2}$ " deep behind panel.
- Weight:** Net 35 lbs. Shipping 51 lbs. (cabinet). Net 33 lbs. Shipping 48 lbs. (rack mount).
- Power:** 115 or 230 v $\pm 10\%$, 50 to 1000 cps, approx. 150 w.
- Price:** hp 122A or 122AR (cabinet or rack mount), \$695. For single sweep operation specify H15-122A or H15-122AR, add \$70.
- Options (no extra charge):**
 - 02. P2 in lieu of P31 phosphor.
 - 05. External graticule crt in lieu of internal graticule.
 - 07. P7 in lieu of P31 phosphor.
 - 11. P11 in lieu of P31 phosphor.

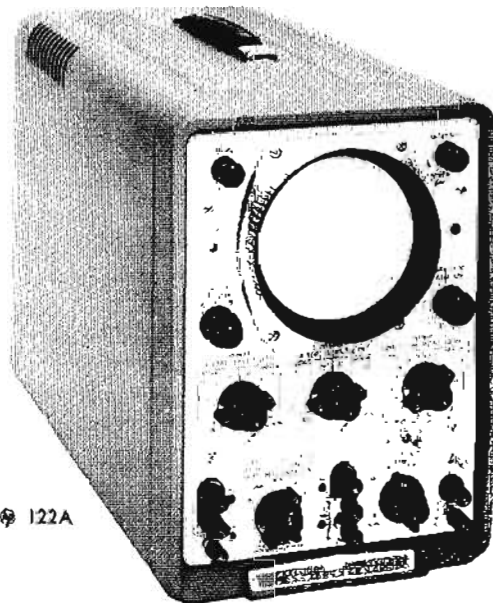

122A

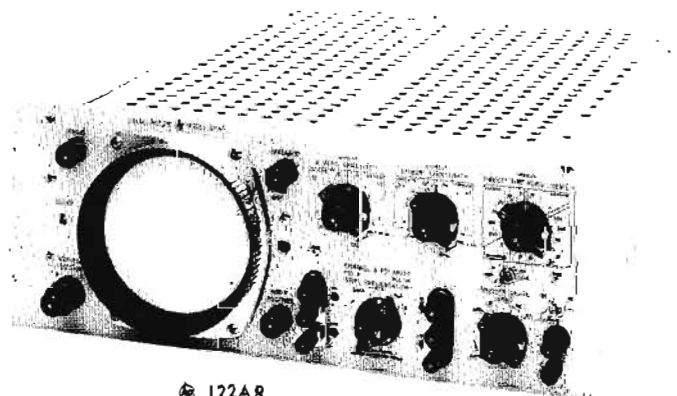

122AR

hp 130C 200 $\mu\text{v}/\text{cm}$ OSCILLOSCOPE

Features Identical Amplifiers for X-Y Plots

Advantages:

- 200 $\mu\text{v}/\text{cm}$ sensitivity eliminates preamplifiers
- 500 kc bandwidth all ranges
- Identical X and Y amplifiers for phase measurements
- Constant impedance and balanced input on all ranges
- x2 to x50 sweep magnification for viewing waveform detail
- Automatic triggering, beam finder simplify operation
- No-parallax, non-glare CRT
- One instrument for rack and bench

Uses:

- General purpose for lab, production and medical applications
- Accurately measures phase shift and time
- Observe output directly from rf detectors, strain gages, transducers
- View complex waveforms

The *hp* Model 130C Oscilloscope, which has identical 200 $\mu\text{v}/\text{cm}$ vertical and horizontal amplifiers with 500 kc bandwidth on all sensitivity settings, is a versatile all-purpose instrument for laboratory, production line, industrial process measurements and medical applications. A x2 to x50 sweep magnifier effectively expands the sweep up to 500 cm for measurement of waveform detail. In addition, a front panel switch allows observation of single shot phenomena or random events by providing single sweep operation. Through the use of both solid state and vacuum tube circuits, the 130C has superior performance, excellent reliability and low power consumption.

Model 130C is easy to operate even by inexperienced personnel. Controls are color coded to front panel markings and are logically arranged by function. An internal graticule CRT provides a bright, clear, non-glare display without parallax. Automatic triggering minimizes adjustments. A positive pushbutton beam finder immediately locates an off-screen trace.

Identical Amplifiers

Identical horizontal and vertical amplifiers provide a high sensitivity of 200 $\mu\text{v}/\text{cm}$ from dc to 500 kc and balanced inputs on all ranges. Balanced output signals from low level transducers such as those used in industrial and medical fields can be measured directly without external amplification. The amplifiers may also be used single ended with ac or dc coupling. Regulated power supplies, high stability components and extensive feedback insure excellent gain stability and low noise even on the most sensitive ranges. A front panel switch (Amplifier AC-DC) provides ac coupling between amplifier stages and virtually eliminates all drift—even on the most sensitive range. Phase shift between amplifiers is held to less than $\pm 1^\circ$ up to 100 kc for accurate phase measurements.

Probes may be used with both the horizontal and vertical amplifiers, and since the input impedance is constant, the probes will not require recompensation between sensitivity ranges.

Automatic Triggering

Trigger adjustments are minimized with the 130C by the "automatic" triggering feature. This feature provides a base

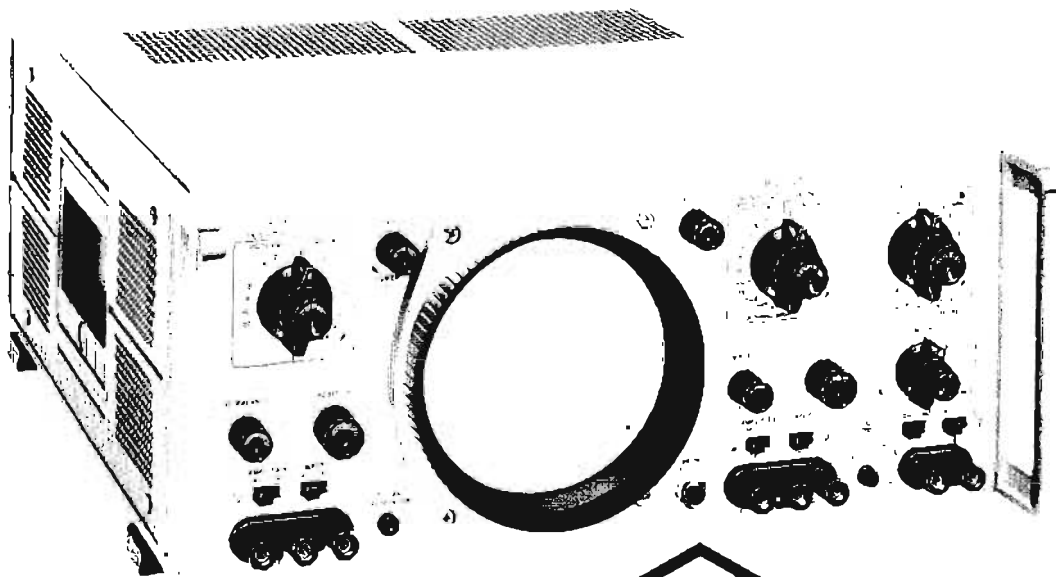

**NEW IN THIS
CATALOG**

line in the absence of an input signal. For fast expanded sweep times where the automatic base line would be too dim for observation, a free run mode establishes a bright base line. A trigger level control is located on the front panel so that automatic triggering may be easily locked out if desired, and a preset trigger level established.

Versatile Sweeps

For versatility, twenty-one linear direct reading sweep times from 1 $\mu\text{sec}/\text{cm}$ to 5 sec/cm are available, accurate within $\pm 3\%$. A calibrated $\times 2$ to $\times 50$ magnifier expands the sweep up to 0.2 $\mu\text{sec}/\text{cm}$, accurate within $\pm 5\%$. A vernier control permits continuous adjustment between calibrated ranges and extends the slowest sweep speed to at least 12.5 sec/cm . In addition, a front panel switch for either normal or single sweep permits observation of single shot phenomena or random events. Switching to single sweep will disable the sweep circuit after a single sweep so that it can not be re-triggered until manually rearmed. A front panel sweep "armed" light indicates when the sweep is armed and ready to be triggered.

No Parallax CRT

The internal graticule of the *hp* Model 130C CRT is in the same plane as the phosphor and trace. In this way the usual vertical and horizontal parallax error, which is inherent in conventional CRT's, is avoided. Waveform measurements are easier, quicker and more accurate since the ambiguity caused by the parallax is eliminated. In addition, the etched safety glass face plate on the CRT of the 130C minimizes reflections and glare which are common in conventional CRT filter and face plates.

Modular Cabinet

The 130C is packaged in the modular cabinet which gives maximum versatility for either bench or rack mounts. Rack mounting brackets (supplied with the instrument) may be quickly attached to convert the unit from bench to a sturdy rack mount. Top and bottom cabinet covers may be quickly removed giving complete access to the components and adjustments within the instrument. When used on the bench, other instruments may be stacked on the top surface.

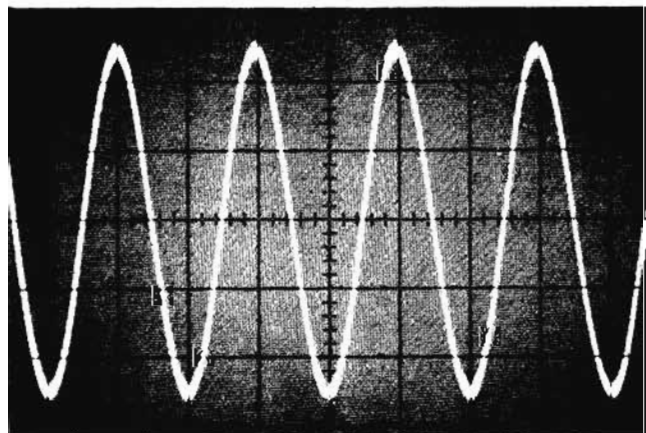

Figure 1. Strain gage output showing resonance in a part (200 $\mu\text{v}/\text{cm}$ sensitivity).

Specifications

Sweep Generator

Internal Sweep: 21 ranges, 1 $\mu\text{sec}/\text{cm}$ to 5 sec/cm , accuracy within $\pm 3\%$. Vernier provides continuous adjustment between ranges and extends slowest sweep to at least 12.5 sec/cm .

Magnification: $\times 2$, $\times 5$, $\times 10$, $\times 20$, $\times 50$, accuracy of magnified sweeps $\pm 5\%$ for sweep rates slower than 0.2 $\mu\text{sec}/\text{cm}$.

Automatic Triggering: Base line is displayed in the absence of an input signal.

Internal: 50 cps to 500 kc signal causing 0.5 cm or more vertical deflection and also from line voltage.

External: 50 cps to 500 kc, 0.5 volts peak-to-peak or more.

Trigger Slope: Positive or negative slope of external sync signals or internal vertical deflection signals.

Amplitude Selection Triggering:

Internal: 10 cps to 500 kc, 0.5 cm or more vertical deflection signal.

External: DC coupled: dc to 500 kc, 0.5 v peak-to-peak or more; ac coupled: 20 cps to 500 kc, 0.5 v peak-to-peak or more.

Trigger Point and Slope: Internally from any point of the vertical waveform presented on screen or continuously variable from + 10 volts to - 10 volts on either positive or negative slope of external signal.

Single Sweep: Front-panel switch permits single sweep operation.

Vertical and Horizontal Amplifiers

Bandwidth:

DC Coupled: DC to 500 kc.

AC Coupled (Input): 10 cps to 500 kc.

AC Coupled (Amplifier): 25 cps to 500 kc at 0.2 mv/cm sensitivity. Lower cut-off frequency is reduced as sensitivity is reduced. At 20 mv/cm the cut-off frequency is 0.25 cps. At lower sensitivities, amplifier is automatically dc coupled.

Sensitivity: 0.2 mv/cm to 20 v/cm . 16 ranges in 1, 2, 5, 10 sequence with an attenuator accuracy within $\pm 3\%$. Vernier permits continuous adjustment of sensitivity between ranges and extends minimum sensitivity to at least 50 v/cm .

Internal Calibrator: Approximately 350 cps square wave; 5 $\text{mv} \pm 3\%$. Automatically connected for checking gain when the sensitivity is switched to CAL.

Input Impedance: 1 megohm shunted by 45 pf, constant on all sensitivity ranges.

Input Capacitor Rating: 600 v peak (dc + ac).

Balanced Input: On all sensitivity ranges.

Common Mode Rejection: At least 40 db from 0.2 mv/cm to 0.2 v/cm sensitivity; common mode signal not to exceed 4 volts peak-to-peak. At least 30 db from 0.5 volts/cm to 20 volts/cm; common mode signal not to exceed 40 v peak-to-peak from 0.5 v/cm to 2 v/cm sensitivities and 400 v peak-to-peak from 5 v/cm to 20 v/cm sensitivities. Specified rejection from dc to at least 50 kc.

Phase Shift: Within $\pm 1^\circ$ relative phase shift at frequencies up to 100 kc with verniers in CAL position and equal input sensitivities.

General

Calibrator: Approximately 350 cps, 500 $\text{mv} \pm 2\%$ available at front panel.

Cathode Ray Tube: *hp* type, (P31) internal graticule, monoaccelerator, 3000 volts accelerating potential. P2, P7, and P11 phosphors are available. Equipped with non-glare safety glass faceplate.

Internal Graticule: Parallax-free 10 cm x 10 cm, marked in cm squares. 2 mm subdivisions on major horizontal and vertical axis and at the 10% and 90% amplitudes (1st and 9th cm) of full scale to facilitate rise-time measurements.

Beam Finder: Depressing beam finder control brings trace on CRT screen regardless of setting of balance, position or intensity controls.

Intensity Modulation: Terminals on rear; + 20 volt pulse blanks CRT at normal intensity.

Power: 115 or 230 volts $\pm 10\%$, 50 to 1000 cps, approximately 90 watts.

Dimensions: 16 $\frac{3}{4}$ " wide, 7-5/16" high, 18 $\frac{3}{8}$ " deep overall; hardware furnished for quick conversion to 7" x 19" rack mount. Rack mount depth, 16 $\frac{3}{8}$ ".

Weight: Net 32 lbs. Shipping 45 lbs.

Accessories Available: A complete line of accessories, including voltage divider probes, current probe and amplifier, test mobiles, and adapters is listed on pages 54-55.

Price: \$695.

Options (no extra charge):

02-P2 in lieu of P31.

07-P7 in lieu of P31.

11-P11 in lieu of P31.

Data subject to change without notice.

AVAILABLE
FALL 1963

hp 140A OSCILLOSCOPE

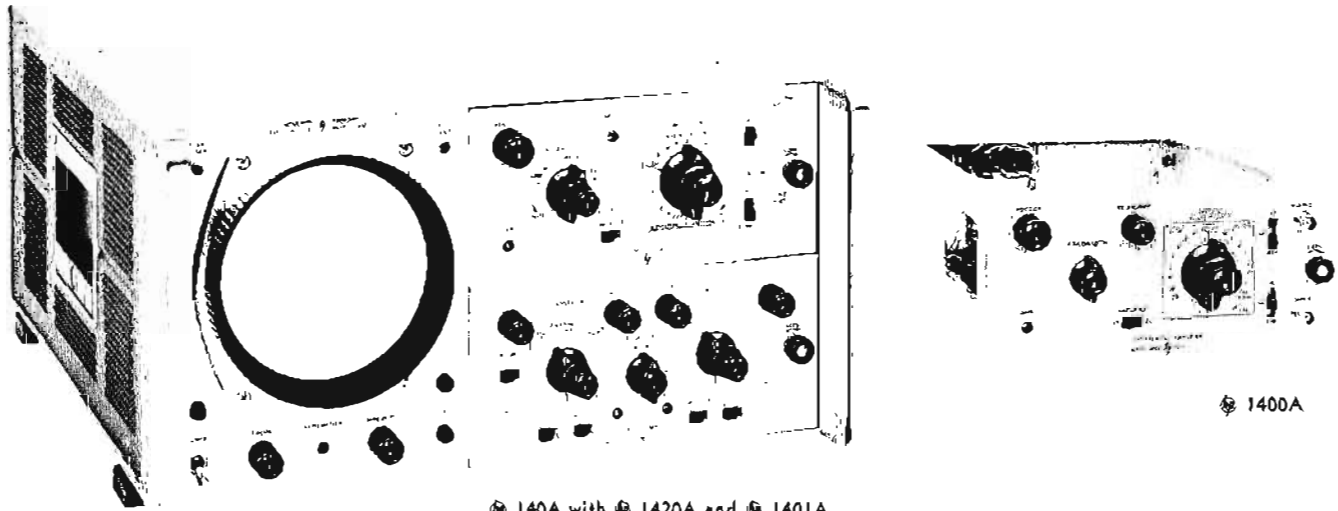

Ⓢ 140A with Ⓢ 1420A and Ⓢ 1401A

Advantages:

- Accepts one dual or two single plug-ins
- 7.5 kv CRT provides bright, clear trace
- Internal graticule eliminates parallax error
- 1% calibrator for accurate sensitivity check
- High sensitivity, wide band

Uses:

- General-purpose lab and production oscilloscope
- X-Y, phase shift measurements
- Strain gage measurements, medical applications

Unique dual plug-in design in the 140A Oscilloscope provides maximum measurement capability, with all active functions except for power supplies, calibrator and cathode ray tube provided by the plug-in units. For normal operation a sweep generator is installed in the upper plug-in receptacle and an amplifier in the lower receptacle. Since the receptacles are identical in size, two vertical amplifiers may be installed to provide x-y measurement capability.

Future plug-in design is not limited to the size of a single plug-in, since the center shield between the compartments may be removed to accept a double-size plug-in unit¹.

A newly developed 7.5 kv internal graticule CRT provides bright, clear, parallax-free traces on the large 10 x 10 cm display area. Improved characteristics of this new CRT give the 140A high frequency as well as high sensitivity capabilities. Front panel controls include a beam finder for fast, positive location of an off-screen trace. A 1 v and 10 v calibrator, accurate to 1%, provides a convenient means of checking sensitivity of the plug-ins and compensating probes.

¹For information regarding additional plug-ins, including those for wide band applications, consult your *hp* sales representative.

Specifications

Plug-Ins: Accepts 1400 series plug-ins. Upper compartment for horizontal axis and lower compartment for vertical axis. Center shield may be removed to provide double-size compartment for use with single, dual-axis 1400 series plug-ins.

Beam Finder: Pressing beam finder control brings trace on screen regardless of settings of horizontal or vertical position control.

Calibrator: 1 v and 10 v peak-to-peak line frequency rectangular signal, 0.5 μ sec rise time. Amplitude is accurate to $\pm 1\%$ + 15°C to + 35°C, $\pm 3\%$ 0°C to + 55°C.

Intensity Modulation: Approximately + 20 volts pulse will blank trace of normal intensity. Terminals on rear panel.

Cathode Ray Tube: Hewlett-Packard post accelerator, 7.5 kv accelerating potential, aluminized P31 phosphor standard (P2, P7 and P11 are available at no extra charge). Equipped with non-glare safety-glass faceplate. Graticule: Parallax-free, 10 x 10 cm marked in cm squares; 0.2 mm subdivisions on major horizontal and vertical axis.

Power: 115 or 230 v $\pm 10\%$, 50 to 60 cps, 285 watts maximum (varies with plug-ins used).

Weight: 37 lbs., without plug-ins.

Dimensions: 16 $\frac{3}{4}$ " wide, 9" high, 18 $\frac{3}{8}$ " deep overall. Hardware furnished for quick conversion to 8 $\frac{3}{4}$ " x 19" rack mount, 16 $\frac{3}{8}$ " deep behind panel.

Accessories Available: A complete line of accessories including voltage divider probes, current probe and amplifier and adapters is listed on pages 54 and 55.

Price: Price on request.

Options: 02. CRT with internal graticule and P2 phosphor installed.

07. CRT with internal graticule and P7 phosphor installed.

11. CRT with internal graticule and P11 phosphor installed.

Ⓢ 1400A Differential Amplifier

Advantages:

- 100 μ v/cm sensitivity eliminates need for preamps
- Noise elimination through selectable bandwidths
- Differential input for suppressing common modes
- Low dc drift

The Model 1400A Differential Amplifier, with a sensitivity of 100 μ v/cm and dc to 400 kc bandwidth, measures outputs from strain gages and transducers without preamplification. This plug-in is particularly suited for laboratory, production, industrial process measurements, and medical applications where small signals are likely to be measured.

Two of the Model 1400A differential amplifiers may be used in the *hp* Model 140A Oscilloscope for x-y presentations. Accurate phase measurements can be made, since the relative phase shift between amplifiers is typically 1° or less to 100 kc.

Specifications

Bandwidth:

Upper Limit: 400 kc, 40 kc, 4 kc, selectable with front panel switch.

Lower Limit: DC with amplifier and input coupling in dc. AC coupled (input); 2 cps. AC coupled (amplifier); dc from 20 v/cm to 50 mv/cm sensitivities. Approx. 0.1 cps on 20 mv/cm sensitivity, increasing with sensitivity to approximately 20 cps at 0.1 mv/cm.

Sensitivity: 0.1 mv/cm to 20 v/cm in 17 calibrated ranges in a 1, 2, 5, 10 sequence. Vernier allows continuous adjustment between calibrated ranges and extends minimum sensitivity to at least 50 v/cm.

Attenuator Accuracy: $\pm 3\%$.

Internal Calibrator: 6 cm line frequency rectangular signal when attenuator switched to CAL. Accuracy $\pm 3\%$.

Input Impedance: 1 megohm shunted by 45 pf, constant on all attenuator ranges.

Input Capacitor Rating: 600 volts dc (input ac coupled).

Dual Inputs: Two signal input jacks (BNC, \pm polarity). AC, DC, or OFF on either input selectable with front panel switches. Isolation between inputs at least 80 db.

Differential Input: Differential input may be selected on all attenuator ranges. Common mode rejection at least 40 db on 0.1 mv/cm to 0.2 v/cm ranges, signal not to exceed 4 v p-p. On 0.5 v/cm to 20 v/cm ranges, at least 30 db, signal not to exceed 40 v p-p on 0.5, 1 and 2 v/cm ranges and 400 v p-p on 5, 10, and 20 v/cm ranges. Measured at 1 kc.

Phase Shift: When used with another 1400A plug-in, typically within $\pm 1^\circ$ relative phase shift at frequencies up to 100 kc with x and y sensitivities the same and verniers in CAL.

Power: Supplied by 140A Oscilloscope.

Weight: Net 4 lbs.

Price: Price on request.

1401A Dual Trace Amplifier

Advantages:

- 1 mv/cm sensitivity for low level measurements
- Dual channel for time and waveform comparisons
- Differential input suppresses common mode signals

The Model 1401A permits simultaneous comparison of two electrical signals, such as input and output of amplifiers and filters, with ease and accuracy. Its two 450 kc channels, each with a sensitivity of 1 mv/cm, may be used independently, together in chopped or alternate modes for simultaneous display of two signals, or in a differential mode of operation for measurements on balanced lines when common mode suppression is desired.

Specifications

Mode of Operation:

Channel A alone. Channel B alone. Channels A and B displayed on alternate sweeps. Channels A and B displayed by switching at approximately 100 kc rate, with blanking during switching. Channel A minus Channel B (differential input).

Each Channel:

Sensitivity: 1 mv/cm to 10 v/cm in 13 calibrated ranges in a 1, 2, 5, 10 sequence. Vernier allows continuous adjustment between calibrated ranges and extends minimum sensitivity to at least 25 v/cm.

Attenuator Accuracy: $\pm 3\%$.

Pass Band:

Upper Limit: 450 kc all sensitivities.

Lower Limit: DC with amplifier and input coupling in dc.

AC coupled (input): 2 cps.

AC coupled (amplifier): DC on 10 v/cm to 20 mv/cm sensitivity ranges. Approx. 1 cps at 10 mv/cm increasing with sensitivity to approx. 10 cps at 1 mv/cm.

Input Impedance: 1 megohm shunted by 45 pf, constant on all attenuator ranges.

Input Capacitor Rating: 600 volts dc (ac coupled input).

Polarity of Presentation: + up or - up selectable for A Channel.

Differential Input:

Both channels, with their input attenuators, may be switched to one channel to give differential input.

Amplifier: Channel A.

Display: A minus B.

Common Mode Rejection: Common mode rejection at least 40 db on 1 mv/cm to 0.1 v/cm ranges, signal not to exceed 4 v p-p. On 0.2 v/cm to 10 v/cm, at least 30 db, signal not to exceed 40 v p-p on 0.2, 0.5, and 1 v/cm ranges and 400 v p-p on 2, 5, 10 v/cm ranges. Measured at 1 kc.

General:

Internal Calibrator: 6 cm line frequency rectangular wave when sensitivity switch at CAL. Accuracy $\pm 3\%$.

Weight: 5 lbs.

Power: Supplied by 140A Oscilloscope.

Price: Price on request.

1420A Time Base

Advantages:

- Stable triggering to greater than 10 mc
- Automatic triggering locks in waveforms
- Sweep speeds to 0.1 μ sec/cm for fast phenomena
- Single sweep for observing transients

The Model 1420A Time Base supplies sweep time, trigger and horizontal input functions to the 140A Oscilloscope. Sweep speeds from 0.5 μ sec/cm to 5 sec/cm are provided on the sweep time switch and a x5 magnifier increases fastest speed to 0.1 μ sec/cm. The magnifier expands the trace that is around the center of the CRT permitting examination of waveform detail. Adjusting the horizontal position control allows examination of any portion of the trace.

Both automatic triggering, for connect and read convenience from 40 cps to 500 kc, and amplitude selection triggering are employed. In amplitude selection triggering the instrument has trigger capabilities from dc to greater than 10 mc. Single sweep operation for viewing transients and single shot phenomena is established by a front panel switch.

Specifications

Internal Sweep: 22 ranges. 0.5 μ sec/cm to 5 sec/cm, accuracy within $\pm 3\%$. Vernier provides continuous adjustment between ranges and extends slowest sweep to at least 12.5 sec/cm.

Magnification: x5, accuracy $\pm 5\%$. Expands fastest sweep to 0.1 μ sec/cm.

Automatic Triggering: Base line displayed in the absence of an input signal.

Internal: 40 cps to 500 kc signal causing 0.5 cm or more vertical deflection; also from line voltage.

External: 40 cps to 500 kc, 0.5 volts peak-to-peak or more.

Trigger Slope: Positive or negative slope of external trigger source signals or internal vertical deflection signals.

Amplitude Selection Triggering:

Internal: 10 cps to greater than 10 mc. 0.5 cm or more vertical deflection at approximately 1 mc and below. Increasing to 2 cm at 10 mc.

External: DC coupled: DC to 10 mc with 0.5 v peak-to-peak or more. AC coupled: 10 cps to 10 mc with 0.5 v peak-to-peak or more.

Trigger Point and Slope: Internally from any point of the vertical waveform presented on screen or continuously variable from + 10 volts to - 10 volts on external signal; positive or negative slope.

Single Sweep: Front panel switch permits single sweep operation.

Horizontal Input: DC coupled. Approximately 1 v/cm or 5 v/cm sensitivity depending on magnifier setting. Input impedance 1 megohm shunted by less than 50 pf.

Weight: 5 lbs.

Power: Supplied by 140A Oscilloscope.

Price: Price on request.

Data subject to change without notice.

HIGH FREQUENCY OSCILLOSCOPES

Hewlett-Packard high frequency oscilloscopes have vertical deflection amplifiers with passbands extending from dc to as high as 50 mc. Because of the broader range of applications for these scopes, plug-ins are provided for both the vertical and horizontal deflection systems.

Three Hewlett-Packard scopes are included in the high frequency category, the rugged 160B and 170A military scopes and the Model 175A general purpose laboratory and production line scope, a versatile, general purpose instrument.

Cathode Ray Tubes

High frequency oscilloscopes require cathode ray tubes with higher electron beam energies to accommodate the faster deflection speeds. An additional accelerating potential, known as a post-acceleration voltage, is applied between the gun and phosphor screen regions to obtain the higher electron energies.

The newly-designed cathode ray tube in the *hp* Model 175A Oscilloscope uses a total of 12 kv of accelerating potential for a bright display. The tube has 6 cm of vertical deflection and virtually uniform focus throughout the display area, while achieving a twofold increase in deflection sensitivity.

The Hewlett-Packard developed cathode ray tube obtains this improved performance by using a shaped electrostatic post-accelerating field. The ground level equipotential surface is established by a curved high-transmission mesh at the exit side of the deflection region (the electron beam passes through the mesh). The field distribution is further controlled by a high-resistive path, painted along the inside of the bulb in a carefully dimensioned pattern. This path establishes a potential gradient, in conjunction with the mesh, which develops a radial electrostatic field, i.e., the equipotential surfaces are spherical. The electron beam does not curve inwards while traveling through this field, as it does in other types of CRT's with post-acceleration. Furthermore, the lower deflection voltages required by this tube cause less defocusing of the beam towards the edges of the display area.

Sweep magnification can be used with the new tube without causing uneven illumination of the display area. In other tubes, this illumination is caused by secondary electrons from the deflection plates. The mesh rejects most secondaries, minimizing stray illumination of the screen.

A thin aluminum film on the inner face of the phosphor enhances the bril-

liance of all *hp* high-frequency scopes. This film acts as a mirror to reflect inward-directed phosphor light, light which otherwise would be absorbed in the interior of the tube.

Vertical Section

Plug-in pre-amplifiers add to the versatility of *hp*'s high frequency scopes by adapting the vertical deflection amplifiers to various measurement tasks. The series of plug-ins includes broadband units (to 50 mc), high gain units (to 5 mv/cm), and two- and four-channel units.

The simplified main vertical amplifier of the 175A achieves broadband performance through a fresh approach to an old technique. The old technique concerns the use of cathode-followers as low impedance drivers for each stage of amplification, allowing reliable, frame-grid triodes to be used as amplifiers in spite of their relatively high input capacitance. The fresh approach is to cross-couple the cathode-followers, as shown in Figure 1, to lower the output impedance of the cathode-followers even further. The main amplifier has only 10 tubes and but 4 adjustments for frequency response.

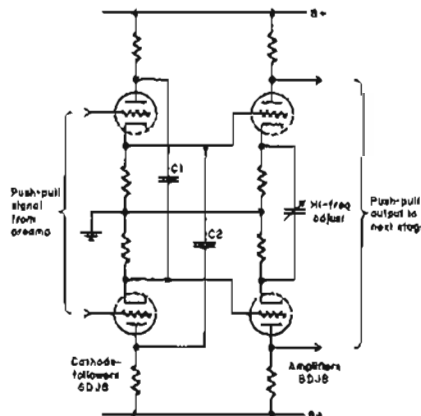

Figure 1. Simplified schematic of one amplifier stage in *hp* 175 oscilloscope vertical amplifier chain. Cathode-followers are cross-coupled by capacitors C1 and C2.

Freedom from overshoot permits the convenient relationship between rise time and bandwidth, $t_r \approx 0.35/BW$, to be applied here. For instance, the 1751A fast rise vertical plug-in with the 175A oscilloscope has a bandwidth of 50 mc; rise time then approximately equals $0.35/50 \times 10^6$, which yields 7 nsec.

Delay lines in the vertical amplifier enable viewing of the leading edge of the waveform which triggers the sweep. Sync takeoff occurs ahead of the delay line, allowing the sweep circuit sufficient time to get under way before the

leading edge is actually displayed. The *hp* high frequency scopes use a coaxial cable delay line requiring no frequency compensating adjustments, rather than lumped-element delay lines which have many interacting adjustments.

Compensated Probe

Coaxial cables are used to take the test signal into a high frequency oscilloscope because of the shielding that coaxial cables provide. To compensate for the loss in high frequency performance arising from cable capacitance, the probe end of the cable has a compensated resistive divider. As shown in Figure 2, the probe's series resistance

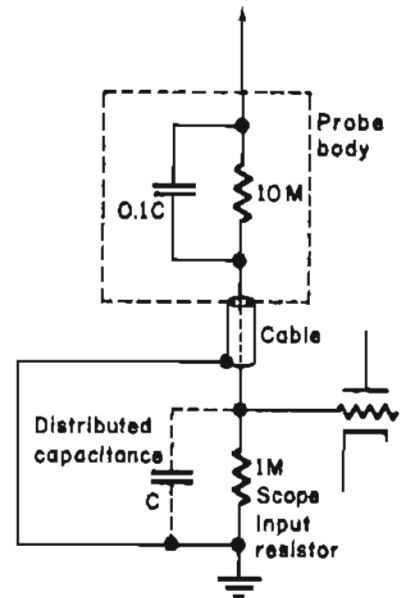

Figure 2. Representation of compensated 10:1 divider probe.

is bypassed by a small capacitor having one-tenth the value of the distributed capacitance. The high frequency impedance of this capacitor is 10 times as high as the impedance of the distributed capacitance, corresponding to the probe's resistance being 10 times as high as the input resistance of the scope. The signal division ratio, therefore, remains constant throughout a broad range of frequencies while the effective probe input capacitance is far less than the cable capacitance.

Horizontal Section

The sweep generator, triggering circuits and related controls are all included in the main frame of *hp* high frequency oscilloscopes. The synchronizing circuits differ from those in the low frequency scopes, though, because of the faster repetition rates encountered in high frequency work.

The *hp* 175A has a sensitive tunnel-diode trigger circuit which generates sharp, jitter-free triggers far more reliably than other trigger circuits. The tunnel-diode circuit maintains constant amplitude at high repetition rates and also counts down on high frequency signals. Internal triggers, therefore, are never so closely spaced that sweep jitter results. Consequently, the 175A provides stable displays even when triggering on signals with repetition rates higher than 50 mc (Figure 3).

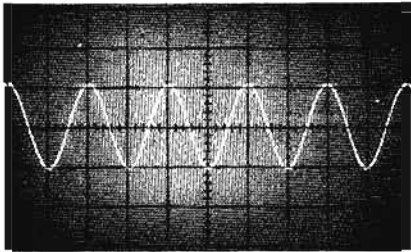

Figure 3. Recurrent trace exposure of 50 mc signal displayed on *hp* 175A shows freedom from jitter when syncing on high frequency signals.

Horizontal Plug-Ins

The horizontal plug-ins add special capabilities to scope performance at the user's option. For instance, the basic instrument can be purchased without a delaying sweep, but this unit may be added later if required by unforeseen applications.

The auxiliary plug-in is a basic, low-cost unit which supplements the normal oscilloscope sweep circuits by providing single-sweep capability. The marker generator plug-in simplifies measurements of time intervals by providing closely spaced time interval markers. These markers brighten the trace momentarily at 0.1, 1, or 10 μ sec intervals, as selected by a front panel control.

The display scanner plug-in enables recording of fast, repetitive waveforms at slow speed on an x-y or strip-chart recorder. This plug-in uses the sampling technique (described more fully on page 44) to obtain a slow-speed reconstruction of the waveform appearing on the crt. Besides driving a recorder, the "slowed-down" waveform may be fed to tape recorders or wave analyzers for further detailed analysis.

A manual scan provision allows the display scanner to "stop" at any part of the waveform for precision measurement of the waveform amplitude with a digital voltmeter.

The delay generator is another plug-in sweep generator, similar in operation to the scope's main sweep. It has pick-off circuitry for generating a delayed

trigger pulse when the delaying sweep waveform reaches a selected amplitude level (point B, Figure 4). The delayed

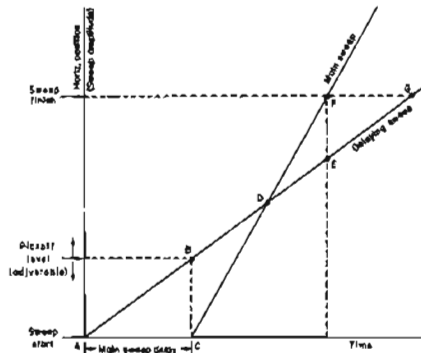

Figure 4. Representation of electron beam horizontal position vs time in oscilloscope using delaying sweep generator.

trigger may then be used to start the scope's main sweep. This capability is used in a variety of ways for the study of complex waveforms.

The delay generator's sweep selector has four modes. On "Main Sweep," the scope's main sweep generator drives the horizontal deflection in conventional manner, as represented by the line CDE in Figure 4. On "Delaying Sweep," the plug-in's sweep generator operates the deflection circuits (line ABDEG, Figure 4). Also, the delayed trigger starts the main sweep and the unblanking pulse from the main sweep

brightens the trace (segment BDE) for the duration of the faster main sweep. This feature allows the operator to select a portion of the total waveform for further study.

Switching to Main Sweep Delayed now places the main sweep generator in control of the horizontal deflection circuit (line CDE), but it continues to be triggered by the delaying sweep trigger. Thus, the brightened portion of the previous display is now expanded to fill the CRT screen.

"Mixed Sweep" operation transfers control of the horizontal deflection from the delaying sweep to the main sweep when they reach the same amplitude (point D). The sweep waveform now corresponds to the bent line ABDE, so that the latter part of the trace is expanded. Thus, pulses in a complex train may be analyzed individually in the expanded part of the sweep while earlier portions of the pulse train are retained for reference.

Militarized Oscilloscopes

The *hp* Models 160B and 170A are general purpose high frequency scopes for both military and commercial applications where extreme environments are encountered. These instruments were designed for military acceptance using MIL-E-16400 as design guide. A condensed listing of the environmental specifications which these scopes must meet follows:

SUMMARY OF ENVIRONMENTAL SPECIFICATIONS FOR MODELS 160B, 170A and PLUG-IN UNITS

TEST	APPLICABLE MIL SPECIFICATION	BRIEF DESCRIPTION
Preconditioning	MIL-T-945 ¶ 4.4.1	Storage from -65°C (-85°F) to 85°C (185°F) at altitudes up to 50,000 feet (3.4" Hg).
Temperature, Humidity and Altitude	MIL-O-22237 ¶ 4.5.5.4.5	Satisfactory operation from -28°C (-18°F) to 50°C (122°F) at altitudes up to 10,000 feet (20.6" Hg) and under humidity up to 95%.
Vibration	MIL-T-945 ¶ 4.4.5	Vibration with 0.060" excursion 10 to 33 cps and 0.030" excursion 10 to 55 cps, three principal axes. Three minute vibration at each of the 4 most severe resonant frequencies.
Shock	MIL-T-945 ¶ 4.4.6	Hammer drop blows 1, 2 and 3 feet, 2 horizontal axes. Blows of 2, 3, and 4 feet on vertical axes.
Drip-proof Test for Combination Case	MIL-E-16400 ¶ 3.11.9	Storage under a 1" diameter spray nozzle in upright position and with 4 sides tilted 15° from vertical; 5 minute exposure per side with front cover in place.
Salt Spray Test	MIL-T-945 ¶ 3.35 and MIL-E-16400 ¶ 4.5.16	Parts not covered by MIL-E-16400 or MIL-T-945 shall be given a 100 hour salt spray test per Federal STD No. 151.
Conducted Interference, Radiated Interference	MIL-I-16910 ¶ 3.6.1.1.5	Tests are conducted as described in MIL-I-16910; limits for portable equipment apply.
Susceptibility to Conducted Noise	MIL-O-22237 ¶ 4.5.5.4.10.4	Instrument performs normally with external signal applied.
Fungus Test	MIL-E-16400 ¶ 3.5.2	Materials selected per MIL-E-16400, ¶ 3.5.2.

hp 160B AND hp 170A OSCILLOSCOPES

Militarized High Frequency Oscilloscopes Offer Plug-In Versatility

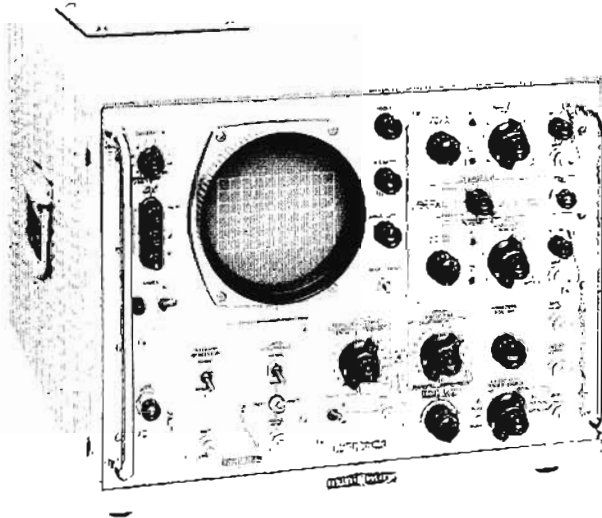

hp 160B with 162A and 166A plug-ins

Models 160B (15 mc) and 170A (30 mc) Oscilloscopes combine militarized design with conventional controls and dual plug-in capability for ruggedness, versatility and utmost convenience—making them ideally suited for shipboard use, mobile calibration vans and system checkout installations. See page 35 for applicable military specifications.

Plug-In Versatility

Changeable vertical and time-axis plug-ins provide expandable measurement capability as it is needed. Selection of plug-ins includes dual channel, high sensitivity and low cost single channel for the vertical axis; auxiliary, time mark and sweep delay for the time axis.

Calibration adjustments are materially reduced in Models 160B and 170A by the elimination of the multi-section delay lines and distributed amplifiers usually associated with high frequency oscilloscopes, simplifying maintenance. Improved preset triggering insures optimum operation for almost all conditions with just one adjustment — even on signals down to 2 mm deflection. A pushbutton beam finder automatically locates off-screen beam or trace greatly facilitating operation, especially by inexperienced personnel.

Specifications

Sweep Generator with hp 166A Auxiliary Plug-In

Internal Sweep: 24 ranges, 0.1 μ sec/cm to 5 sec/cm \pm 3%. Vernier extends slowest sweep to 15 sec/cm.

Magnification: 7 calibrated ranges, x1, x2, x5, x10, x20, x50 and x100. Increases fastest calibrated sweep speed to 0.02 μ sec/cm. Accuracy: x1, x2, x5, \pm 3%; x10 and x20, \pm 5% to 0.02 μ sec/cm; x50 and x100, \pm 10% to 0.02 μ sec/cm.

Triggering: Internal, power line or vertical input signal (2 mm or more vertical deflection). External ($\frac{1}{2}$ v p-p or more).

Trigger Point: Positive or negative going voltage. Trigger level of external sync signal adjustable — 30 to + 30 v.

Sawtooth Output: Approximately — 40 to + 40 volts.

Gate Output: Approximately + 45 volt pulse.

Horizontal Amplifier with hp 166A Auxiliary Plug-In

Bandwidth: dc to 1 mc.

Sensitivity: 7 calibrated ranges 0.1 v/cm to 10 v/cm. Vernier extends minimum sensitivity to 25 v/cm.

Input Impedance: 1 megohm shunted by 30 pf.

Main Vertical Amplifier

Bandwidth Capability: 160B, rise time less than 23 nsec (dc to 15 mc). 170A, rise time less than 12 nsec (dc to 30 mc).

Calibrator

Type: 1000 cycle square wave, 1 μ sec rise and decay time.

Voltage: 18 calibrated ranges 0.2 mv to 100 v peak-to-peak, \pm 3%.

Current: 5 ma peak-to-peak, \pm 3%.

Cathode Ray Tube

Type: Model 160B: 5AM mono-accelerator, aluminized, 5 kv accelerating potential. Model 170A: 5 BH post-accelerator, 10 kv accelerating potential, P31-AL phosphor. P2-AL, P7-AL, P11-AL also available.

Filter Supplied: Compatible with phosphor, green with P2 and P31, amber with P7 and blue with P11.

Graticule: External, 10 cm long x 6 cm high (160B) 10 cm x 4 cm (170A) marked in centimeter squares; 2 mm subdivisions on horizontal, vertical axes. Controlled edge lighting. Internal graticule, which eliminates parallax error, optional.

Deflection Plate Connection: Pin type terminals.

Intensity Modulation: + 20 v pulse will blank CRT trace of normal intensity.

General

Power Requirements: 115 or 230 volts \pm 10%, 50 to 440 cps.

Model 160B approx. 480 watts; Model 170A approx. 500 watts.

Color: Grey enamel in accordance with Type III Class 2 of specification MIL-E-15090.

Dimensions: 14 $\frac{3}{8}$ " high, 19" wide, 22 $\frac{1}{8}$ " deep (cabinet); 12 $\frac{1}{4}$ " high, 19" wide, 22" deep behind panel (rack mount).

Weight: Net 85 lbs. Shipping 108 lbs. (cabinet and rack mount).

Accessories Available: hp 10165A front cover to provide drip proofing for the instrument. Includes two UG 255/U adapters (uhf female-to-BNC male), two UG 273/U adapters (uhf male-to-BNC female), four 10110A adapters (dual banana plug female-to-BNC male), two UG 274B/U connectors (BNC female tees), and two 160B-16T cables (8 ft. long, male BNC connectors). The cover also provides space for the furnished accessories and the instruction manual, \$100. A complete series of accessories including voltage and current probes, current amplifiers, viewing hoods, testmobiles, special adapters, and service aids are also available to provide maximum versatility of the 160B, 170A Oscilloscopes. These accessories are listed on pages 54 and 55.

Accessories Furnished: One each hp 10001A,B Probes, 10:1 voltage division; Power Cable Assembly, 90" min.

Options: 02. P2-AL in lieu of standard phosphor, no extra cost;

03. internal graticule CRT in lieu of standard CRT, P2, P7, P11,

P31 phosphors available, add \$30; 04. ac fan in lieu of dc fan,

no extra cost; 07. P7-AL in lieu of standard phosphor, no extra

cost; 11. P11-AL in lieu of standard phosphor, no extra cost.

Price: 160B (cabinet), 160BR (rack mount), \$2050. With all

tubes and semiconductors MIL approved, \$2250 (specify H02-

160B). 170A (cabinet), 170AR (rack mount), \$2150. With all

tubes and transistors MIL approved, \$2350 (specify H02-170A).

Note: Both the standard and the H02 versions meet the environ-

mental specifications.

See "Environmental Specifications for hp Models 160B and 170A

Oscilloscopes and Plug-in Units" for detailed specifications. Avail-

able from Hewlett-Packard Company or your Hewlett-Packard

representative.

Militarized Vertical and Time Axis

Plug-Ins for hp 160B, 170A

Oscilloscopes

Four vertical amplifier plug-ins and three time axis plug-ins are available. These plug-ins are designed to the same strict military specifications that guide the design of the 160B and 170A Scopes.

hp 162A Dual Trace Amplifier

This vertical plug-in provides sensitivity to 20 mv/cm, permits viewing of two signals simultaneously in either a

chopped or alternate presentation and offers differential input for common mode rejection.

Specifications

Each Channel

Sensitivity Range: 0.02 v/cm to 20 v/cm, 10 calibrated ranges in 1, 2, 5, 10 sequence. Vernier to at least 50 v/cm.
Attenuator Accuracy: $\pm 3\%$.
Pass Band: With 170A: dc coupled, dc to 22 mc; ac coupled; 2 cps to 22 mc. With 160B: dc coupled, dc to 14 mc; ac coupled, 2 cps to 14 mc.
Rise Time: Less than 16 nsec in 170A and 25 nsec in 160B.
Input Impedance: 1 megohm (nominal) shunted by less than 30 pf.
Polarity of Presentation: + up or - up, selectable.
Differential Input: Both input attenuators may be switched to one channel to give differential input. The input attenuators may be set separately to allow mixing signals of different levels.
Common Mode Rejection: At least 40 db at maximum sensitivity, at least 30 db when using attenuators.
Price: \$375; with all tubes and semiconductors MIL approved \$420 (specify H02-162A).

162B Dual Trace Vertical Amplifier

Model 162B permits dual channel measurements over the full bandwidth of the 160B (15 mc) and 170A (30 mc). Maximum accuracy and reliability is obtained through the use of simplified circuitry. Chopped, alternate and differential inputs provide maximum user versatility.

Specifications

Each Channel

Sensitivity Range: 0.05 v/cm to 20 v/cm. Nine calibrated ranges in 1, 2, 5, 10 sequence. Vernier extends minimum sensitivity to at least 50 v/cm and provides continuous adjustment between ranges.
Attenuator Accuracy: $\pm 3\%$.
Pass Band: In 170A: dc coupled, dc to 30 mc, ac coupled, 2 cps to 30 mc. In 160B: dc coupled, dc to 15 mc; ac coupled, 2 cps to 15 mc.
Rise Time: Less than 12 nsec in 170A, 23 nsec in 160B.
Dynamic Range: Input amplifiers may be overloaded by 18 cm signal without causing noticeable signal distortion.
Vertical Position Control Range: ± 9 cm.
Input Impedance: 1 megohm (nominal) shunted by 28 pf.
Input Capacitor Rating: 600 v dc.
Polarity of Presentation: + up or - up, selectable.
Differential Input: Both inputs, with their associated attenuators, may be switched to one channel to give differential input. The input attenuators may be set separately to allow mixing signals of different levels.
Common Mode Rejection: At least 40 db at maximum sensitivity up to 1 mc, or 30 db when using attenuators.
Price: \$350; with all tubes and semiconductors MIL approved \$390 (specify H02-162B).

162D High Gain Vertical Amplifier

Sensitivity of the 160B or 170A is increased to 5 mv/cm with this versatile plug-in. At this sensitivity the 162D, 170A combination has a rise time of less than 19 nsec. Differential input is included.

Specifications

Sensitivity: 5 mv/cm to 20 v/cm, 12 ranges in 1, 2, 5, 10 sequence. Vernier extends minimum sensitivity to at least 50 v/cm.
Attenuator Accuracy: $\pm 3\%$.
Dual Inputs: Two jacks (BNC); ac or dc coupling, isolation between inputs at least 80 db.
Differential Input: 5 mv/cm to 50 mv/cm, common mode rejection at least 40 db.
Pass Band:

With 170A:	DC Coupled	AC Coupled
50 mv/cm and above:	dc to 22 mc	2 cps to 22 mc
20 mv/cm to 5 mv/cm:	dc to 18 mc	2 cps to 18 mc
With 160B:		
50 mv/cm and above:	dc to 14 mc	2 cps to 14 mc
20 mv/cm to 5 mv/cm:	dc to 12 mc	2 cps to 12 mc

Rise Time: In 170A: 20 mv/cm range and below, 19 nsec; 50 mv/cm range and above, 16 nsec. In 160B: 20 mv/cm range and below, 29 nsec; 50 mv/cm range and above, 25 nsec.
Price: \$250; with all tubes and semiconductors MIL approved \$260 (specify H02-162D).

162F Fast Rise Preamplifier

The low cost 162F allows full use of the excellent transient response of the 160B and 170A main vertical amplifiers. Rise time with the 170A is 12 nsec, bandpass dc to 30 mc (3 db points). With the 160B, rise time is 23 nsec,

bandwidth dc to 15 mc. Sensitivity is 50 mv/cm with either 170A or 160B.

Specifications

Pass Band: With 170A: dc coupled, dc to 30 mc; ac coupled, 2 cps to 30 mc. With 160B: dc coupled, dc to 15 mc; ac coupled, 2 cps to 15 mc.
Rise Time: Less than 12 nsec in the 170A, 23 nsec in the 160B.
Sensitivity Ranges: 0.05 v/cm to 20 v/cm. Nine ranges in 1, 2, 5, 10 sequence. Vernier to at least 50 v/cm.
Attenuator Accuracy: $\pm 3\%$.
Input Impedance: 1 megohm (nominal) shunted by 25 pf.
Price: \$170; with all tubes and semiconductors MIL approved \$185 (specify H02-162F).

166A Auxiliary Plug-In

The 166A Auxiliary Plug-in fits into the receptacle for 160B and 170A time axis plug-in units and provides the connections for normal oscilloscope operation. This plug-in also provides single sweep capability with provisions for either manual or electrical arming.

Specifications

Intensity Modulation: Normal or external; + 20 v pulse will blank CRT trace of normal intensity.
Sweep Occurrence: Normal or single sweep.
Sweep Arming: Internal or external pulse.
External Arming Pulse Required: 1 to 200 μ sec, approximately + 15 to + 25 volts peak.
Price: \$35; with MIL approved components \$35 (specify H02-166A).

166B Marker Generator

Precise time measurements are easy to make with the 166B Marker Generator, which provides intensity modulated time markers on the oscilloscope trace. External output features make possible the use of markers as triggers or for calibration of other devices.

Specifications

Intensity Modulation Markers

Range: 10 μ sec, 1 μ sec, or 0.1 μ sec intervals.
Accuracy: $\pm 0.5\%$.

Presentation: Trace-intensifying marks with duration a function of intensity, but always less than 40% of marker interval.
Synchronization: Triggered by sweep gate; synchronized to CRT presentation.

External Output Markers

Range: 10 μ sec, 1 μ sec, or 0.1 μ sec intervals.
Accuracy: $\pm 0.5\%$.

Amplitude: 0 to 1 volt peak (positive) into open circuit, adjustable.
Waveform: Positive polarity clipped sine wave with duration a function of amplitude, but always less than 40% of marker interval.

Output Impedance: Approximately 75 ohms.

Price: \$155; with tubes and semiconductors MIL approved \$165 (specify H02-166B).

166D Sweep Delay Generator

Detailed examination of a complex signal or pulse train is possible with this time-axis plug-in. A unique mixed sweep feature permits viewing of an expanded waveform segment while still retaining a presentation of earlier portions of the waveform.

Specifications

Delay Time: 1 μ sec to 10 sec.

Delaying Sweep: 18 calibrated ranges from 2 μ sec/cm to 1 sec/cm in 1, 2, 5, 10 sequence.

Delayed Length: 0 to 10 cm.

Accuracy: $\pm 1\%$ on 2 μ sec to 0.1 sec ranges; $\pm 3\%$ on 0.2, 0.5, 1 sec ranges. $\pm 0.2\%$ linearity, all but 2, 5, and 10 μ sec ranges. $\pm 0.5\%$ linearity, 2, 5, and 10 μ sec ranges.

Jitter: Less than 0.01 μ sec or $\pm 0.005\%$ of total delay.

Delay Functions: (a) Trigger main sweep; (b) Arm main sweep.
Triggering: Internal, power line or vertical input signal ($1/2$ cm or more vertical deflection). External, $1/2$ volt peak-to-peak or more.

Triggering Point: Positive or negative going voltage. Trigger level of external sync signal adjustable from - 30 to + 30 volts.

Sweep Selector: (a) Main Sweep; (b) Delaying Sweep, brightened segment of trace indicates time relationship between Delaying Sweep display and Main Sweep display; (c) Main Sweep Delayed; (d) Mixed Sweep.

Delayed Trigger Output: Approximately 20 volts positive.

Price: \$400; with all tubes and semiconductors MIL approved \$435 (specify H02-166D).

Data subject to change without notice.

hp 175A 50 MC OSCILLOSCOPE

Versatile 50 MC Scope Provides Large, Bright 6 x 10 CM Display

**NEW IN THIS
CATALOG**

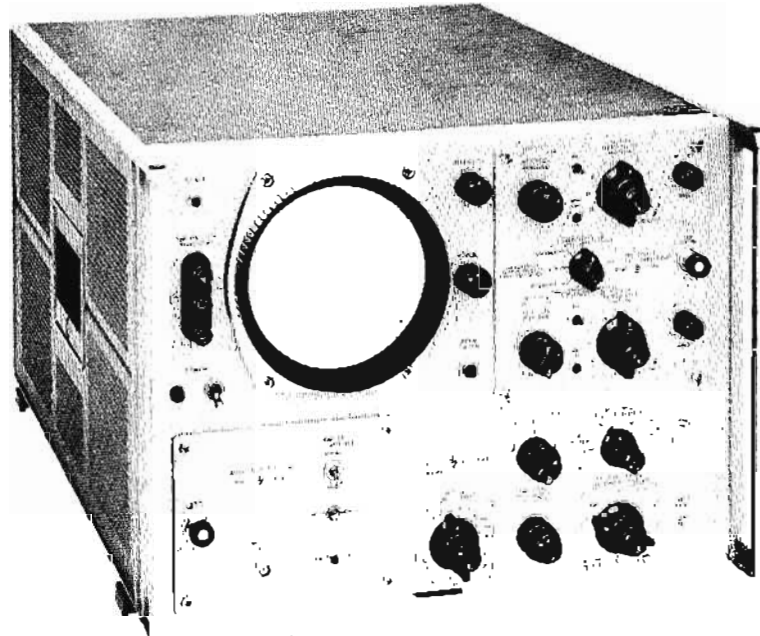

Ⓢ 175A with 1750A and 1780A plugged in

Advantages:

- Bright, sharp trace, 6 x 10 cm display
- Plug-ins provide bandwidths to 50 mc
- No-parallax, non-glare CRT increases accuracy
- Vertical and time axis plug-ins for specific applications
- Eight plug-ins provide maximum versatility
- Easy to calibrate and maintain, few adjustments, no distributed amplifiers or delay line adjustments
- Positive syncing over entire bandwidth

Using a Hewlett-Packard-developed post-accelerator cathode ray tube with large 6 x 10 cm display area, the *hp* 175A represents a major advance in oscilloscope design. Model 175A has provisions for both vertical amplifier and time axis plug-ins. Eight currently available plug-ins, including a 50 mc single channel amplifier and a 40 mc dual channel amplifier, insure versatility. Circuitry has been simplified, making it easier to adjust and maintain. In addition, extra features such as the improved triggering, logically arranged controls and convenient beam finder make the oscilloscope easier to use.

New Cathode Ray Tube

The CRT, developed by *hp* especially for the Model 175A, gives 6 cm of vertical deflection (a 50% increase in viewing area over previously available high frequency tubes) and thus provides bigger, clearer pictures. An additional feature of this CRT is its low level of distortion. Deflection defocusing, which causes widening of the trace at extremes of deflection, is so low that no front panel astigmatism control is necessary, and pin cushion or barrel distortion is virtually unmeasurable. The tube provides clear, sharp traces over the entire display area, making the signals much easier to read and photograph.

This CRT is operated with a 12-kv accelerating potential that with the P31 aluminized phosphor, insures brightness and a more-than-adequate writing rate. Thus the oscilloscope is convenient for observing or recording single-shot phenomena.

In addition, the tube is equipped with an internal graticule which eliminates parallax error, and an optically flat non-glare faceplate reduces reflections to a minimum.

Vertical Amplifier

The vertical amplifier in the 175A provides over 50 mc of bandwidth and is easier to maintain and simpler to adjust than previously available designs. Difficult to adjust distributed amplifier techniques and lumped constant delay lines are not used; an *hp*-developed coaxial delay line is used in conjunction with conventional circuitry to achieve wide bandwidth. The main vertical amplifier has only seven tubes, and all of these are a rugged frame grid type. Such simplified circuitry reduces calibration time and increases reliability.

Two Sets of Plug-Ins

In addition to accepting plug-in vertical amplifiers, the 175A also accepts a series of time axis plug-ins which greatly extend its versatility. This added versatility enables you to add such features as sweep delay or display scanning when needed and adapts one instrument for several widely differing measurements. Four vertical and four horizontal plug-ins are presently available. In different combinations they equip the 175A for almost any test application.

Simple, Accessible Circuits

Maximum emphasis has been given to ease of service and maintenance. Component and test-point accessibility is extremely good; tubes and other components are easy to remove

and replace if necessary; all etched circuit boards are connected into the circuit with solderless "edge-on" connections (see Fig. 1) simplifying their removal and replacement. Wherever practical, reliable frame grid triodes have been used in preference to other types. The Model 175A uses a total of only seven vacuum tube and five transistor types, thus minimizing the number of spares required in maintenance or service shops.

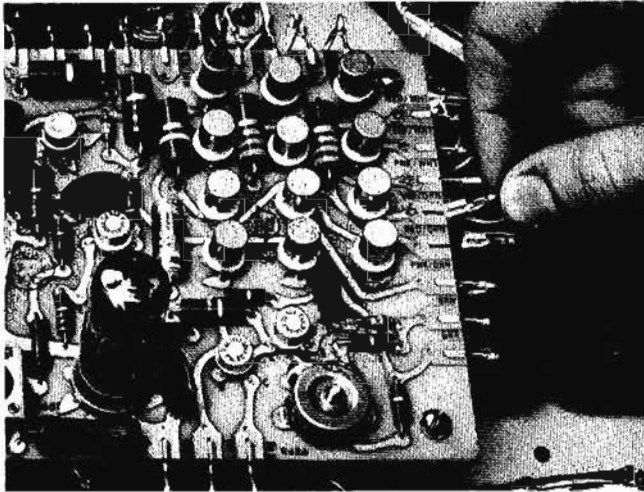

Figure 1. Etched circuitry with solderless connectors simplifies servicing and maintenance.

User Conveniences

A single preset adjustment establishes optimum triggering for almost any signal within the instrument's bandwidth. Employing a newly developed tunnel diode circuit to achieve this performance, the preset synchronization eliminates most adjustments while, and even before, signals are applied and makes possible simpler and faster measurements.

Another feature of the *hp* 175A is a pushbutton beam finder which automatically locates the off-screen spot or trace.

The horizontal amplifier of the 175A provides two sweep magnifications; $\times 1$ for normal operation, and $\times 10$ for examining any 1 cm section of the normal display. The expanded section is selected by centering it with the horizontal position controls. Further, the horizontal amplifier also can be used as an external sweep amplifier and has calibrated sensitivities of 1 v/cm and 0.1 v/cm.

New Cabinetry

Advanced cabinet design, also featured in the 175A, contributes both to ease of use and ease of maintenance. The oscilloscope is equally suited for bench use or for rack mounting and is easily converted from one to the other whenever desired. The top and bottom cabinet covers can be quickly removed for access to all the components and adjustments. When rack mounted, the dimensions are EIA standard (12 $\frac{1}{4}$ " x 19" and 22 $\frac{3}{8}$ " deep behind panel); when used on the bench, other instruments may be stacked on the top.

Specifications

Sweep Generator

Range: 0.1 μ sec/cm to 5 sec/cm in 1, 2, 5 sequence, 24 steps. Vernier provides continuous adjustment between ranges and extends slowest sweep to at least 12.5 sec/cm.

Magnification: $\times 10$: increases maximum sweep speed to 10 nsec/cm.

Accuracy: $\pm 3\%$, $\pm 5\%$ with $\times 10$ magnifier.

Triggering: Internal: ac coupled, power line; external: ac or dc coupled.

Triggering Sensitivity: Internal, approx. 2 mm vertical deflection at 1 mc, 2 cm at 50 mc. External, approx. 0.25 volts peak-to-peak at 1 mc, approx. 0.5 volts peak-to-peak at 50 mc.

Triggering Point: Controls allow selection of level and slope.

Horizontal Amplifier

Bandwidth: DC coupled, dc to 500 kc; ac coupled, 2 cps to 500 kc.

Sensitivity: 2 ranges; 0.1 v/cm and 1 v/cm. Vernier provides continuous adjustment between the ranges and extends minimum sensitivity to 10 v/cm.

Input Impedance: 1 megohm shunted by approx. 30 pf.

Main Vertical Amplifier

Rise Time: Less than 7 nsec.

Calibrator

Type: 1 kc square wave, approx. 3 μ sec rise time.

Voltage: 2 ranges, 1 v and 10 v peak-to-peak $\pm 1\%$ from $+15\%$ to $+35\%$ ambient temperature, $\pm 3\%$ 0°C to 55°C ambient temperature.

Cathode Ray Tube

Type: Post accelerator, 12 kv accelerating potential. P31 aluminized phosphor standard, other phosphors (P2, P7, and P11) are available at no extra charge. Equipped with non-glare safety glass face plate.

Writing Rate: A single 6 cm step function displaying 7 nsec main vertical amplifier rise time can be photographed with the *hp* 196B Oscilloscope Camera.

Graticule: Internal, parallax-free 6 x 10 cm, marked in cm squares. 2 mm subdivisions on major axis, and also 6 mm above bottom graticule line and 6 mm below top graticule line (10% and 90% points for rise time measurements).

Beam Finder: Depressing beam finder control brings trace on CRT screen regardless of setting of horizontal or vertical position controls or intensity control.

Intensity Modulation: Approximately $+20$ volt pulse will blank trace of normal intensity (BNC connector on rear panel).

General

Power: 115 or 230 v $\pm 10\%$, 50 to 60 cps. 425 watts max. (depends on plug-ins used).

Dimensions: 16 $\frac{3}{4}$ " wide, 12 $\frac{1}{4}$ " high, 24 $\frac{3}{8}$ " deep overall; hardware furnished for quick conversion to 12 $\frac{1}{4}$ " x 19" rack mount, 22 $\frac{3}{8}$ " deep behind panel.

Weight: Net approx. 70 lbs. max. (with heaviest plug-ins installed). Shipping 84 lbs.

Accessories Furnished: One each *hp* 10003A,C Probes 10:1 voltage dividers; detachable power cord; rack mounting hardware.

Accessories Available: Testmobiles, viewing hoods, current probe and amplifier and adapters are some of the many accessories available. A complete selection of accessories is listed on pages 54 and 55.

Price: \$1325. (without plug-ins).

Options: 02. CRT with internal graticule and P2 phosphor, installed, no extra charge; 07. CRT with internal graticule and P7 phosphor installed, no extra charge; 08. Unblanking gate (approx. 4 v for duration of sweep) and sweep sawtooth (approx. -2.5 v to $+2.5$ v) outputs on rear panel, add \$25; 11. CRT with internal graticule and P11 phosphor installed, no extra charge.

Data subject to change without notice.

VERTICAL PLUG-INS FOR 175A OSCILLOSCOPE

NEW IN THIS
 CATALOG

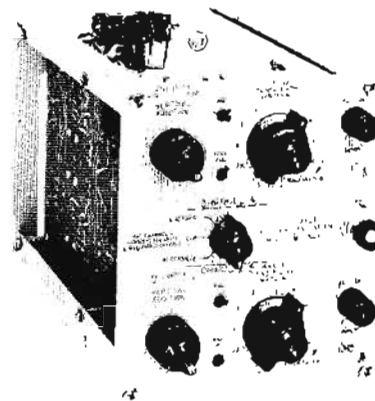

 1750A

1750A Dual Trace Vertical Amplifier

The 1750A permits direct comparison of two electrical signals with ease and accuracy. Its independent vertical input amplifiers, each with a bandwidth of 40 mc and a maximum sensitivity of 50 mv/cm, can be used separately or together in five different modes of operation. In all five of these modes each channel attenuator operates separately, allowing comparison of signals of widely differing magnitudes. Each channel has independent positioning controls, so the base lines of waveforms can be superimposed for comparison or separated for easy viewing.

An outstanding feature of the 1750A is its provision for differential operation at frequencies from dc to 40 mc. In this mode the output from both input attenuators is connected to the Channel A amplifier, and the difference between them displayed on the oscilloscope. This makes possible the examination of differential or balanced signals, and at the same time attenuates undesirable common mode signals such as hum. In differential operation, the A and B channel input attenuators may be set separately to allow mixing of different level signals.

Specifications

(Installed in the Model 175A)

Mode of Operation

(1) Channel A alone; (2) Channel B alone; (3) Channels A and B displayed on alternate sweeps; (4) Channels A and B displayed by switching at 200 kc rate, with blanking during switching; (5) Channel A minus Channel B (differential input).

Each Channel

Sensitivity Range: 0.05 v/cm to 20 v/cm. Nine calibrated ranges in 1, 2, 5, 10 sequence. Vernier extends minimum sensitivity to at least 50 v/cm.

Attenuator Accuracy: $\pm 3\%$.

Pass Band: DC coupled, dc to 40 mc; ac coupled, 2 cps to 40 mc.

Rise Time: Less than 9 nsec.

Dynamic Range: Input amplifiers may be overloaded by 18 cm signal without causing noticeable signal distortion.

Vertical Position Control Range: ± 9 cm.

Input Impedance: 1 megohm shunted by approx. 28 pf.

Input Capacitor Rating: 600 v dc (ac coupled input).

Polarity of Presentation: + up or - up, selectable for each channel.

Differential Input

Both inputs, with their associated attenuators, may be switched to one channel to give differential input. The input attenuators may be set separately to allow mixing signals of different levels.

Amplifier: Channel A.

Amplifier Input: A minus B.

Common Mode Rejection: At least 40 db at maximum sensitivity or 30 db when using attenuators at frequencies to 1 mc.

Display: Input A minus Input B.

General

Weight: Net 5 lbs. Shipping 7 lbs.

Power: Supplied by *hp* 175A Oscilloscope.

Price: \$285.*

1751A 50 MC Single Channel Vertical Amplifier

The *hp* 1751A combines 50 mc bandwidth with 50 mv/cm sensitivity. Because of the excellent transient response of the 175A Main Vertical Amplifier, the 1751A-175A combination provides less than 7 nsec rise time for accurate measurement of fast waveforms. Simplified, stable circuitry is used in the 1751A to minimize adjustments and simplify calibration and maintenance.

Specifications

(Installed in the Model 175A)

Pass Band: DC coupled, dc to 50 mc; ac coupled, 2 cps to 50 mc.

Rise Time: Less than 7 nsec.

Sensitivity: Nine calibrated ranges in 1, 2, 5, 10 sequence from 0.05 v/cm to 20 v/cm. Vernier provides continuous adjustment between ranges, extends minimum sensitivity to at least 50 v/cm.

Attenuator Accuracy: $\pm 3\%$.

Input Impedance: 1 megohm (nominal) shunted by approx. 22 pf.

Input Capacitor Rating: 600 v dc (ac coupled input).

Power: Supplied by *hp* 175A Oscilloscope.

Weight: Net 5 lbs. Shipping 7 lbs.

Price: \$160.*

1752A High Gain Vertical Amplifier

Model 1752A plug-in increases sensitivity of the 175A to 5 mv/cm. Calibrated ranges include 5 mv/cm through 20 v/cm, with a vernier providing continuous adjustment between ranges. At maximum sensitivity the rise time of the

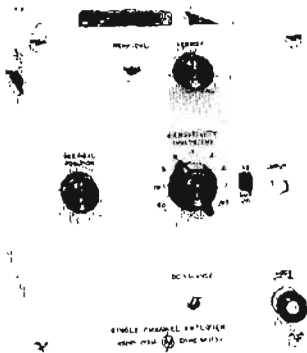

hp 1751A

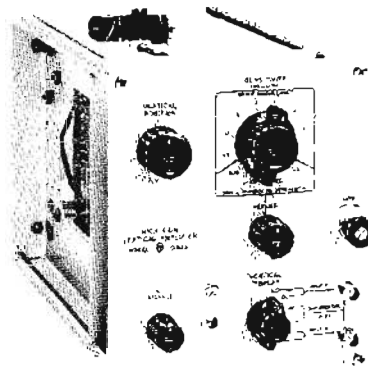

hp 1752A

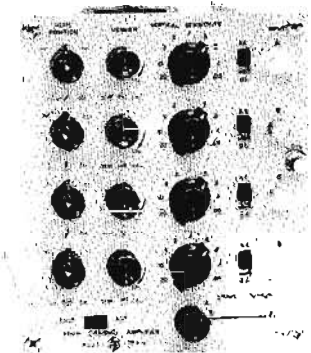

hp 1754A

1752A-175A combination is less than 20 nsec, improving to approximately 16 nsec on the less sensitive ranges. Differential input with at least 40 db common mode rejection is included for the ranges 5 mv/cm through 50 mv/cm. Either ac or dc coupling is selected by a vertical display switch, which also selects input A, input B or differential. Substantial feedback in the transistor amplifier stage provides unusually high stability for a high gain amplifier.

Specifications

(Installed in the Model 175A)

- Sensitivity:** 5 mv/cm to 20 v/cm in 12 calibrated ranges in 1, 2, 5, 10 sequence. Vernier allows continuous adjustment between calibrated ranges and extends minimum sensitivity to at least 50 v/cm. A sensitivity calibration adjustment is provided on the front panel.
- Attenuator Accuracy:** $\pm 3\%$.
- Dual Inputs:** Two signal input jacks (BNC), ac or dc coupling of either input selectable with front panel switch. Isolation between inputs at least 80 db.
- Differential Input:** AC or dc differential input may be selected in the ranges of 5 mv/cm to 50 mv/cm. Common mode rejection at least 40 db. Common mode signal should not exceed 4 volts p-p.
- Pass Band:** DC coupled: 50 mv/cm range and above, dc to 22 mc; 20 mv/cm to 5 mv/cm range, dc to 18 mc. AC coupled: identical except down 3 db at 2 cps.
- Rise Time:** 50 mv range and above, less than 16 nsec; 20 mv range and below, less than 20 nsec.
- Input Impedance:** Approximately 1 megohm with less than 35 pf shunt capacitance.
- Input Capacitor Rating:** 600 v dc (ac coupled input).
- Weight:** Net 5 lbs. Shipping 7 lbs.
- Power:** Supplied by hp 175A Oscilloscope.
- Price:** \$225.*

hp 1754A Four Channel Vertical Amplifier

The hp 1754A permits direct comparison of four signals simultaneously on the large 6 x 10 cm display of the 175A Oscilloscope, making it ideal for observing signals in computer logic. Each of its vertical amplifiers has a bandwidth of 40 mc, sensitivity of 50 mv/cm, and independent positioning controls so that waveforms can be superimposed for easy comparison. Switching between channels is either at a free-running rate of 1 mc or alternately on successive sweeps. For accurate timing measurements the 175A can be triggered from any of the vertical channels.

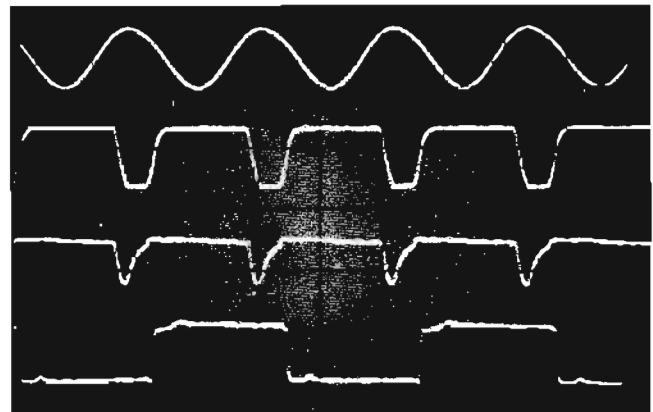

Four fast signals displayed on the hp 175A

Specifications

(Installed in Model 175A)

Mode of Operation

Channels may be displayed individually or together on successive sweeps or by switching between channels at a 1 mc rate, with blanking during switching.

Each Channel

- Sensitivity Range:** 0.05 v/cm to 20 v/cm. Nine calibrated ranges in 1, 2, 5, 10 sequence. Vernier extends minimum sensitivity to at least 50 v/cm.
- Attenuator Accuracy:** $\pm 3\%$.
- Pass Band:** DC coupled, dc to 40 mc; ac coupled, 2 cps to 40 mc.
- Rise Time:** Less than 9 nsec.
- Input Impedance:** 1 megohm shunted by approx. 20 pf.
- Input Capacitor Rating:** 600 v dc (ac coupled input).
- Polarity of Presentation:** + up or - up, selectable for each channel.
- Triggering Output:** Output suitable to trigger 175A externally.

General

- Weight:** Net 7 lbs. Shipping 9 lbs.
- Power:** Supplied by hp 175A Oscilloscope.
- Price:** \$595.*
- *Accessories Available: See pages 54 and 55 for voltage divider probes, current probe and amplifier and adapters.

Data subject to change without notice.

HORIZONTAL PLUG-INS FOR hp 175A OSCILLOSCOPE

NEW IN THIS
CATALOG



hp 1781B

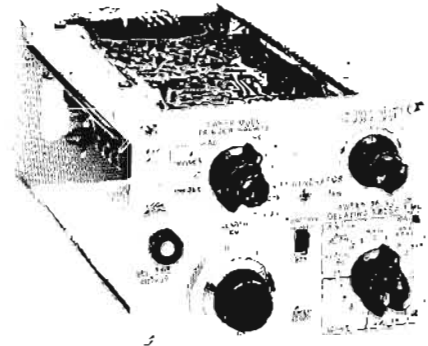

hp 1780A

hp 1780A Auxiliary Plug-In

The hp 1780A allows the 175A Oscilloscope to perform all the functions of a standard instrument. With the 1780A the scope offers repetitive sweep operation, plus single sweep operation, with either internal or external arming.

Specifications

(Installed in the Model 175A)

Sweep Occurrence: Normal or Single Sweep.
Sweep Arming: Manual (pushbutton) or by external pulse.
External Arming Pulse Required: 1 to 200 μ sec, approximately + 15 to + 25 volts peak.
Input Connector: BNC.
Weight: Net 1 lb. Shipping 4 lbs.
Price: \$25.

hp 1781B Sweep Delay Generator

This versatile plug-in offers a variety of sweep delay capabilities and permits measurement of the time delay between a reference signal and a particular point on a complex signal or a train of pulses, measurement of pulse-to-pulse intervals on a pulse train, time-jitter measurements and, with mixed sweep, observation of signals at both slow and fast sweep speeds.

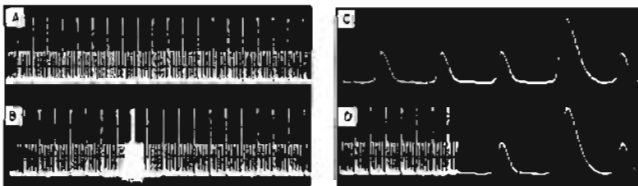

Figure 1. Four types of sweeps possible with the Model 1781B are shown in the photographs above. They are: (a) Main Sweep, (b) Delaying Sweep (with the section covered by the delayed main sweep intensified); (c) Main Delayed Sweep (with the intensified section expanded to fill the entire horizontal 10 cm); and (d) Mixed Sweep (in which the trace is initially driven by the delaying sweep and then by the fast main sweep).

Main Sweep: This function "locks out" the 1781B Sweep Delay Generator allowing the 175A to perform as a normal oscilloscope.
Delaying Sweep: Provides fast setup by intensity modulating those pulses to be displayed in Main Delayed position.

Main Delayed Sweep: Two modes of operation are provided. (1) The start of the scope trace is delayed from the reference signal by an amount determined by the settings of the front-panel delay controls; thus, time jitter between the reference signal and the

observed signal can be conveniently measured since the observed signal can be magnified using a fast main sweep. (2) The 175A sweep generator may be armed, but not triggered, at the end of the selected delay interval. The next signal (the signal under observation) triggers the 175A sweep. The resulting trace is steady and free from jitter even when jitter is present in the signal being observed. Thus, accurate measurements of pulse-to-pulse spacing may be made easily.

Mixed Sweep: In this function the display is presented, using two separate sweep speeds, the slower speed determined by the sweep in the 1781B plug-in and the faster speed by the sweep generator in the 175A Oscilloscope. The point in time at which the sweep converts from slow sweep to fast sweep is determined by the delay settings on the 1781B. In this function it is possible to view simultaneously the character of a pulse train and also "peel off" and expand individual pulses, for minute inspection, at the end of the train.

Main Single Sweep: A switch on the hp 1781B allows single sweep operation of the 175A sweep generator for displaying transient and other single-shot phenomena. The sweep may be armed either manually with a push button or electrically. A sweep armed light indicates when the sweep is ready to be triggered.

Specifications

(Installed in the Model 175A)

Delay Time: 1 μ sec to 10 sec Delay Time (the product of the Delaying Sweep setting in sec/cm, and the Delay Length setting in cm).
Delaying Sweep: 2 μ sec/cm to 1 sec/cm. 18 calibrated ranges in a 1, 2, 5, 10 sequence.
Delay Length (the distance from the beginning of the trace, to the point at which the main sweep is triggered): 0 to 10 cm.
Accuracy: $\pm 1\%$, 2 μ sec/cm to 0.1 sec/cm ranges; $\pm 3\%$, 0.2, 0.5, 1 sec/cm ranges.
Linearity: $\pm 0.2\%$.
Jitter: Less than $\pm 0.002\%$ of maximum delay of each range.
Delay Functions: (a) Trigger main sweep; (b) Arm main sweep.
Triggering: Internal, ac coupled (2 mm or more vertical deflection), power line; external, ac or dc coupled ($\frac{1}{4}$ volt p-p or more).
Triggering Point: Controls allow selection of level and slope. Trigger level of external sync signal adjustable.
Sweep Selector: (a) Main Sweep (b) Delaying Sweep; brightened segment of trace indicates time relationship between delaying sweep display and Main Sweep display (c) Main Delayed Sweep (d) Mixed Sweep. (e) Single Sweep of main sweep.
Delayed Trigger Output: Approximately 10 volts positive.
Power: Supplied by hp 175A Oscilloscope.
Weight: Net 4 $\frac{1}{2}$ lbs. Shipping 7 lbs.
Price: \$375.

hp 1782A Display Scanner

Used with an x-y recorder, the Model 1782A Display Scanner permits permanent recordings of the waveform

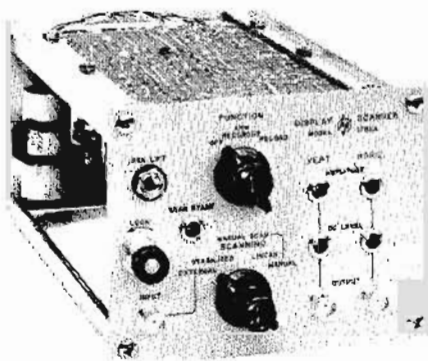

1782A

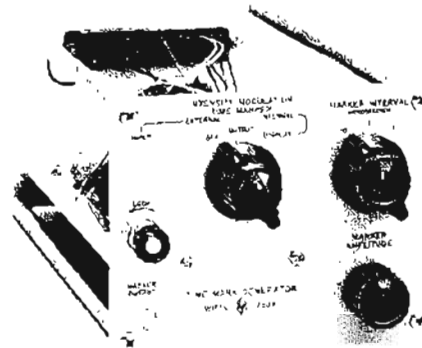

1783A

displayed on the scope CRT. These high resolution recordings are not limited by the width or height of the CRT display, but may be as large as the physical size and sensitivity of the recorder will allow.

The 1782A employs sampling techniques to transform high speed phenomena to the bandwidth of conventional x-y recorders such as the Moseley 135 or 2D (See pages 16 and 17). An automatic pen stabilizer provides a nearly constant writing rate to the recorder so that fast pulses may be recorded faithfully in minimum time. For quick correlation of time between the CRT trace and recorder, the recorder pen position is identified by an intensity change on the CRT trace.

This plug-in also may be used with auxiliary equipment to digitize a CRT display. The desired portion of the trace is scanned once or repeatedly and the output reduced in frequency for recording or analysis. To digitize the display you can monitor the output with a digital voltmeter. Or by scanning with an external sawtooth you can use the 1782A to reduce high speed signals to low speed signals for recording on audio tape recorders.

Specifications

(Installed in the Model 175A)

Vertical Output: Approximately 200 mv/cm, gain and dc level independently adjustable.

Horizontal Output: Output level (dc) adjustable to 0 volts. Output amplitude adjustable from 0 v to + 15 v.

Bandwidth: At least 30 mc when installed in Model 175A with a 40 mc vertical plug-in.

Scanning: Manual, internal (with pen speed either stabilized or linear), or external (External scan voltage approx. 0 to + 15 v).

Scanning Time: Internal, linear: approx. 1½ minutes. Internal, with pen speed stabilized: approx. 25 seconds when displaying time base only.

Oscilloscope Sweep Speed: From fastest sweep to 5 msec/cm; signal repetition rate greater than 20 cps.

Remote Pen Lift: Contact opening provided to lift x-y recorder pen when switching from Record to Arm Recorder.

Power: Supplied by hp 175A Oscilloscope.

Weight: Net 5 lbs. Shipping 7 lbs.

Price: \$425.

1783A Time Mark Generator

The 1783A Time Mark Generator provides synchronized intensity modulated time markers on the 175A Oscilloscope trace. The markers simplify rise time and pulse duration

measurement and are also useful for scope photographs, for calibrating certain sweeps or for operation between calibrated sweep ranges.

The time mark generator is triggered by the sweep gate of the oscilloscope and thus is synchronized to the CRT trace. Markers are selectable at 10, 1 or 0.1 μ sec intervals, accuracy $\pm 0.5\%$. Marker duration is a function of the adjustable intensity but always less than 40% of marker interval. The time markers also may be switched to a front panel BNC output jack, a feature useful for calibrating oscilloscope sweep speeds or external equipment.

Specifications

(Installed in hp 175A)

Functions

Time Marker: Off: marker de-energized. Output: markers provided at BNC output jack. Display: markers provide synchronized intensity modulation of display (intensity modulation control set to Internal).

Intensity Modulation: External: provide input for normal intensity modulation. Internal: allows intensity modulation of trace. (Time markers set to Display.)

Intensity Modulation

Range: 10 μ sec, 1 μ sec, or 0.1 μ sec intervals.

Accuracy: $\pm 0.5\%$.

Presentation: Trace-intensifying marks with duration a function of intensity, but always less than 40% of marker interval.

Synchronization: Triggered by sweep gate; synchronized to CRT presentation.

External Output Markers

Range: 10 μ sec, 1 μ sec, or 0.1 μ sec intervals.

Accuracy: $\pm 0.5\%$.

Amplitude: 0 to 1 v peak (positive) into open circuit, adjustable.

Waveform: Positive polarity clipped sine wave with duration a function of amplitude, but always less than 40% of marker interval.

Output Impedance: Approximately 75 ohms.

General

Power: Supplied by hp 175A Oscilloscope.

Weight: Net 3½ lbs. Shipping 6 lbs.

Price: \$130.

Data subject to change without notice.

SAMPLING OSCILLOSCOPES

Sampling oscilloscopes use a stroboscopic approach to reconstruct the input waveform from samples taken during many recurrences of the waveform, thereby circumventing the bandwidth limitations of conventional cathode ray tubes and amplifiers. This technique is illustrated by the waveforms of Figure 1. In reconstructing a waveform, the sampling pulse "turns on" the sampling circuit for an extremely short interval (less than 1/2 nsec) and the waveform voltage at that instant, shown by the dots on the waveform, is measured. The CRT spot is positioned vertically to the corresponding voltage amplitude.

The next sample is taken during a subsequent cycle at a slightly later point in the input waveform. The CRT spot moves horizontally a short distance and is repositioned vertically to the new voltage. In this way, the scope plots the waveform point-by-point, as many as 1000 samples being used to reconstruct the waveform.

A bright trace is obtained regardless of sampling rate, sweep speed or waveform duty cycle, since each CRT spot remains "on" during the full interval between samples. Also, small fluctuations on large signals may be examined in detail because of the exceptional non-overloading characteristics of the sampling scope. For instance, any part of a 2 v signal may be viewed on the 4 mv/cm range by adjusting vertical position.

The progressive delay in the sampling pulses is derived from the other waveforms shown in Figure 1. Trigger pulses initiate the "real time" ramp, which functions during the portion of the input waveform being examined. When the ramp reaches the voltage level being held by the horizontal deflection circuits, a comparator

circuit generates a pulse which initiates the sampling pulse. The horizontal waveform then steps to a higher level.

The "real time" ramp controls the time base of the reconstructed display. The sweep speed control is labeled in nsec or μ sec per cm and is operated in conventional fashion. Sampling density is determined by the voltage change between steps of the horizontal deflection waveform. Sampling density, therefore, remains constant despite any changes in the sweep speed or sweep magnifier controls, even on the fastest sweeps.

Flexible scanning control allows slow speed scanning, so that the reconstructed waveform may be traced by an x-y recorder. Scanning also may be performed under manual control, permitting point-by-point waveform examination.

Sampling Circuit

The unique sampling circuit outlined in Figure 2, developed by Hew-

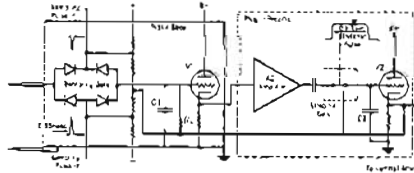

Figure 2. Representation of sampling circuitry in hp 185B Sampling Oscilloscope.

lett-Packard, achieves the high impedance input and minimum circuit loading necessary for circuit probing. During a sampling interval, sampling pulses momentarily bias the four diodes of the balanced sampling gate in the forward direction, briefly connecting input capacitance C_1 to the test point (the balanced bridge minimizes coupling of the sampling pulses back into the test circuit). C_1 which consists only of stray capacitance, is charged toward the new voltage level.

Any voltage change at C_1 is amplified and applied to storage capacitor C_2 through the stretcher gate, represented here as a switch. C_1 accepts only an infinitesimal charge from the test circuit but this voltage step is amplified so that the voltage change at C_2

is the same as the original input waveform change.

The voltage at C_2 is fed back to input resistor R_1 . Because of this feedback, C_1 charges between sampling pulses to the same voltage level that input voltage had during the previous sampling pulse. In effect, the circuit detects the "error" signal between the previous and the new samples and nulls out the difference. High sensitivity and gain stability are achieved. Even though the test circuit supplies only a small charge to C_1 , the display moves completely to a new amplitude level during one sampling interval.

Dual Trace Operation

Separate sampling circuitry and input probes are provided for each channel of the 187B dual-trace plug-in preamplifier. Sampling and "stretching" operations are carried out in both channels simultaneously. This allows simultaneous display of two input waveforms with no displacement in their phase relationship.

Other vertical channel options include the hp 186A Switching Time Tester plug-in, a self-contained test system for evaluating transistor, diode and tunnel diode switching times, and for other pulse response measurements.

Circuit Measurement Considerations

The high impedance probes supplied as integral parts of 187B dual trace preamplifier enable circuit probing in the usual sense with minimum circuit disturbance. When working with fast pulse or high frequency circuits, however, the inductance of any conductor can have an appreciable effect (about 0.025 microhenries per inch) and stray capacitance can resonate with this inductance. The 187B probes have short, low inductance probe pins and spring-loaded ground pins to minimize this effect. Compatible accessories, such as dc blocking capacitors and voltage dividers, are available for extending the usefulness of the probes.

The probe's high input impedance is also advantageous in 50-ohm coaxial systems, since the system does not have to terminate at the probe. The probe can "bridge" the system at any point through the use of a coaxial tee which connects the probe pin to the coaxial center conductor. Other accessories include adapters, which mate the probe directly to BNC or Type N connectors, and sockets which mount directly over routine test points for guiding the probe to the proper point. Accessories are available separately or as a kit.

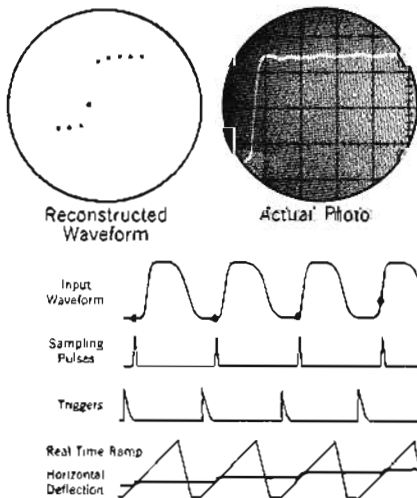

Figure 1. Waveforms pertinent to operation of sampling oscilloscope. Actual photo has 1000 samples which blend into continuous line.

TIME DOMAIN REFLECTOMETRY

Time domain reflectometry is a technique for locating and analyzing discontinuities or mismatches in high-frequency transmission systems. To apply time domain reflectometry, a fast-rise voltage step is fed into the transmission system. Each time that the step encounters an impedance mismatch or discontinuity as it travels through the system, some of its energy is reflected towards the source. The reflections are displayed for evaluation as voltage steps on an oscilloscope.

Examination of the reflections not only makes it possible to identify the location of each individual discontinuity, but the nature of the discontinuity also can be recognized at a glance. Time domain reflectometry makes it possible to measure cable impedances without interference from mismatched connectors, to tune antennas for optimum impedance matching, to adjust attenuators for broadband response, and to perform a host of other measurements on high-frequency components in greater detail and in less time than with standing-wave techniques.

Recent developments in fast pulse generation and observation now enable these measurements to be made in the nanosecond time domain, providing exceptionally fine detail. A typical setup using the *hp* Model 215A Pulse Generator and 185B, 187B Sampling Oscilloscope is shown in Figure 1. Here, the

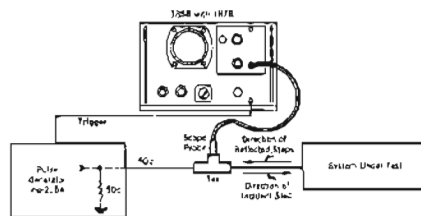

Figure 1. Basic time domain reflectometry setup.

pulse generator repetitively launches fast rise time voltage steps down the transmission system. Energy reflected back toward the pulse generator by impedance discontinuities is absorbed by the 50-ohm termination within the generator. The incident step and returning reflections are observed by the oscilloscope as they pass through the tee where the probe is attached to the system.

Since the voltage step propagates along the system at a finite speed, discontinuities which are separated in distance produce reflections which are separated in time. Each discontinuity can be identified separately on the oscilloscope display and its exact location

determined by evaluation of the corresponding time separation. In addition, the magnitude of the impedance mismatch and its resistive, capacitive, or inductive nature can be determined from the magnitude and shape of the reflection.

Electromagnetic energy travels through most coaxial cables (polyethylene) at a speed about two-thirds of the speed of light, roughly 20 cm per nanosecond. Since the voltage step makes a round trip before returning to the oscilloscope observation point, voltage steps caused by discontinuities spaced 10 cm apart will appear separated by 1 nanosecond on the oscilloscope screen. When the 185B Sampling Oscilloscope sweep speed is set at 0.1 nsec/cm, the display's horizontal scale is equal to distance along the system, indicating the resolution that is possible with this system.

The character of the reflection describes the nature of the cable mismatch, as shown in Figure 2. A purely resistive

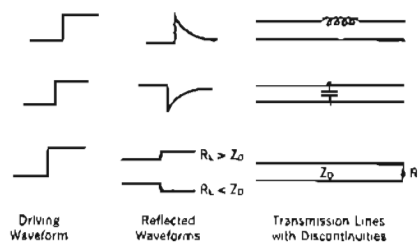

Figure 2. Reflections obtained from impedance discontinuities on transmission lines.

mismatch returns a step identical in shape to the driving waveform; the amplitude of the returned step is proportional to the ratio of characteristic impedances on either side of the discontinuity for small differences. If system impedance following the discontinuity is greater than the preceding section, the step is reflected with the same polarity.

Pure inductance at the mismatch causes a voltage spike to be returned with the same polarity as the driving step, whereas capacitance causes an opposite-going spike.

Of special significance is the fact that the impedance of a cable or other device can be identified separately from intervening connector impedances. This separation means that impedances can be determined with a precision never before possible. As shown in Figure 3, the oscilloscope vertical scale can be calibrated by using cable terminations whose resistance has been precisely measured at dc. The characteristic im-

pedance of a device can then be determined by this calibration. Figure 4

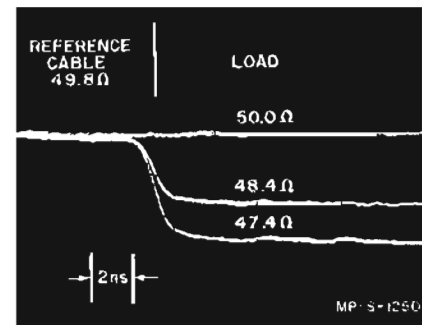

Figure 3. Calibration of oscilloscope vertical scale with known cable terminations.

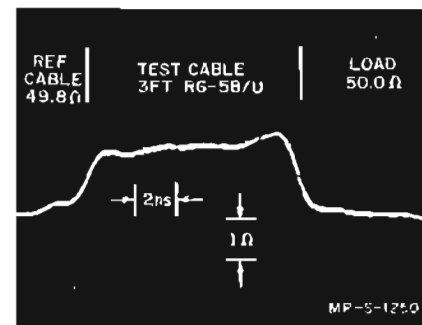

Figure 4. Reflection from 3 feet of RG-58/U cable. Reference cable impedance is 49.8 ohms and termination is 50 ohms.

shows the measurement of a cable where the connector discontinuity, which would have affected a standing-wave measurement, is separated from the actual cable impedance by the pulse reflection technique.¹



For wider divergencies of impedance, this fact is noted: an open-ended cable causes complete reflection, resulting in an oscilloscope deflection that is twice the amplitude of the incident step. The amplitude of this reflection indicates the level of infinite resistance on the oscilloscope vertical scale. A short-circuit termination results in an opposite-going reflection, causing complete cancellation of the driving step. The voltage step baseline therefore establishes the zero resistance level. The mid-center of the vertical scale represents the driving cable impedance. The vertical scale now corresponds to an ohmmeter scale with infinite resistance at the top, zero resistance at the bottom, and a mid-scale range determined by the driving cable impedance.

¹For a complete discussion of the theoretical aspects of time domain reflectometry, please refer to Hewlett-Packard Application Note No. 53, "Transmission Line Testing Using the Sampling Oscilloscope."

185B 1000 MC OSCILLOSCOPE

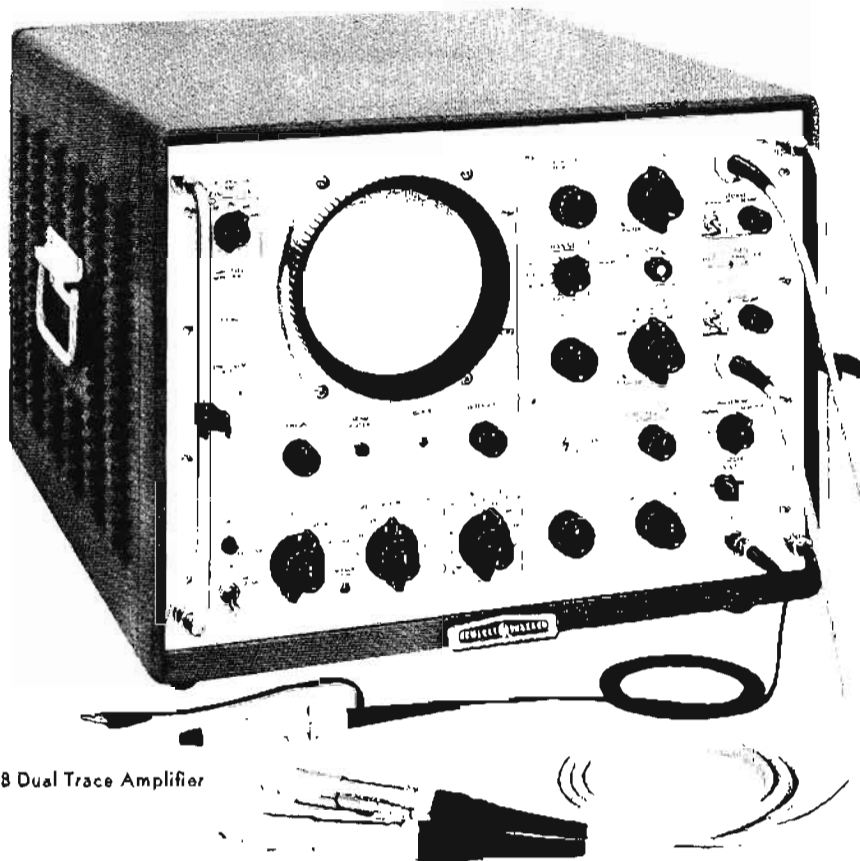
Convenient, Versatile Scope for Nanosecond Measurements



 185B with  187B Dual Trace Amplifier

Advantages

- Bright 10 x 10 cm display of nanosecond signals
- Vertical plug-ins provide bandwidths over 1000 mc while maintaining high sensitivity and wide dynamic range
- Plug-ins for dual trace, fast rise and switching time measurements increase versatility
- High impedance probes minimize loading in dual channel plug-in
- Sweep speeds to 0.04 nsec/cm for extreme time resolution
- Bright, steady traces even at low repetition rates
- Positive synchronizing up to 1000 mc
- X-Y recorder output; time, amplitude calibrators; beam finder; conventional scope controls

Uses

- Measure transistor, diode, computer memory element switching speeds
- Analyze nanosecond and microsecond pulses with one instrument
- Make time comparisons to a fraction of a nanosecond
- Analyze coaxial connectors, cable attenuators, other devices
- Analyze carrier signals by viewing rf directly
- Measure phase angle on signals to 1000 mc through dual channel viewing

The *hp* Model 185B Oscilloscope brings low frequency scope convenience to high frequency measurements. Employing a sampling technique using special Hewlett-Packard high speed diodes, the *hp* 185B offers extremely wide bandwidth while maintaining large bright, easy-to-read displays. Two plug-ins are available for the Model 185B giving it added versatility for fast measurements. In addition to the Model 187B 1000 mc Dual Trace Amplifier plug-in for use where fast rise and minimum loading is important, a Model 186A Switching Time Tester plug-in is offered for semiconductor and general-purpose measurements.

Direct Reading Conventional Controls

With the 185B, direct observation of fast pulse phenomena on a 5" CRT is possible without optical magnification or use of photography because of the full 10 cm x 10 cm display area, fast sweep speeds and high brightness independent of duty cycle. Bright traces are obtained for pulse rates as low as 50 cps. And the *hp* internal graticule completely eliminates parallax error and minimizes glare.

A calibrated 10-position sweep time selector and 7-position sweep magnifier provide direct reading of time. Because sample density and trace duty cycle are independent of magnifier setting, there is no decrease in brightness and accuracy with magnification. For convenience, a beam finder control

quickly locates off screen traces and facilitates its positioning to center screen, no matter how far the position or intensity controls may have been misadjusted.

Versatile Triggering

The Model 185B Oscilloscope will synchronize on signals with repetition rates from 50 cps to 1000 mc. At most sweep speeds the maximum sampling rate is 100 kc, and on these sweeps the oscilloscope synchronizes independently on each input signal from 50 cps to 100 kc. The instrument will thus present a steady display even when signals are randomly spaced. Above 100 kc, hold-off and count-down circuitry is used to provide synchronization on a sub-harmonic of the input wave at a frequency less than 100 kc.

The Model 1100A Delay Line is available for viewing the leading edge of the signal used to trigger the 185B. Versatility can be further increased with a combination of the delay line and a resistive divider probe that increases input resistance. Trigger sensitivity of the 185B is such that "internal" triggering can be obtained over the entire dynamic range of the 187B amplifier.

Recorder Output

Because of the sampling method used in synthesizing the 185B display, it is possible to reduce the rate of advance of the x-axis scan to a speed low enough so that even a relatively slow-speed x-y recorder can follow the trace. X-axis and y-axis recorder outputs are provided, as are three types of scanning: Record, x-axis automatically scanned over a 60-second interval; Manual, scanning by a front-panel control; and, for special applications, External, scanning programmed with external voltages fed to rear panel terminals.

Sync Pulse Output

A fast-rise 1.5 v sync pulse at the oscilloscope's sampling rate, suitably delayed from the start of the scope trace, is available for triggering or testing external circuits. Where this pulse triggers the circuit under test, the leading edge of the output signal may be viewed on the screen without the need for a delay line.

Specifications

Horizontal

Sweep Speeds: 10 ranges, 10 nsec/cm to 10 μ sec/cm, calibrated to $\pm 5\%$. Vernier gives continuous adjustment between ranges and increases fastest unmagnified sweep speed to 4 nsec/cm. Accuracy of the basic sweep is maintained at all magnifier settings with the exception of time represented by first $\frac{1}{4}$ cm of the unmagnified sweep.

Magnification: 7 calibrated ranges x1, x2, x5, x10, x20, x50 and x100. Increases maximum calibrated sweep speed to 0.1 nsec/cm; with vernier, maximum sweep speed is further extended to 0.04 nsec/cm. Intensity and sample density are not affected by magnification.

Delay Control: Three-turn variable delay control is available when using magnified sweep. Permits any magnified portion of unmagnified trace to be viewed.

Minimum Delay (input trigger to start of trace): Less than 120 nsec at 100 nsec/cm sweep and faster. On slower sweep speeds, minimum delay increases to a maximum of approximately 5 μ sec on the 10 μ sec/cm range.

Sample Density: Continuously adjustable from approximately 70 samples per trace to 1000 samples per trace.

Scanning Functions: Internal: x-axis driven by internal staircase for normal viewing. Record: x-axis driven by internal slow ramp; approximately 60 seconds for one trace. Manual: x-axis driven by manual scan control knob. External: x-axis driven by external voltage; approx. 12 v for 10 cm deflection, input impedance $> 25K$.

Trigger Functions

Normal-External Trigger:

Amplitude: ± 150 mv to ± 2 v pk. Up to 5 v rms or 100 v pk will not damage input circuit.

Width: 5 nsec at minimum amplitude.

Rate: 50 cps to 1 mc on the 10 μ sec/cm sweep speed setting. Maximum rate increases to 100 mc on the 200 nsec/cm and faster ranges.

Jitter: Less than 0.03 nsec or 0.02% of the time represented by the unmagnified sweep, whichever is greater (fast rise trigger signals). Reduced approx. 5:1 in the "smoothed" response position.

Input Impedance: 50 ohms nominal, dc coupled. Reflection from a step of $\frac{1}{2}$ nsec rise time is less than 8%.

Sensitive-External Trigger:

Amplitude: ± 15 mv to ± 200 mv pk. Up to 5 v rms or 10 v peak will not damage input circuit.

Width: 5 nsec at minimum amplitude.

Rate: Same as normal.

Jitter: Same as normal.

Input Impedance: 50 ohms nominal, dc coupled.

High Frequency:

Input Frequency: 50 mc to 1000 mc for sweep speeds of 200 nsec/cm and faster.

Sensitivity: 200 mv p-p. Operates from smaller signals at some increase in jitter. Up to 5 v rms or 15 v peak will not damage the input circuit.

Jitter: 5% of cycle from 50 to 400 mc; 8% of cycle from 400 to 1000 mc.

Internal Signal appearing at Input Connector: Less than 15 mv p-p, approx. 10 mc.

Input Impedance: 50 ohms nominal, ac coupled. Reflection from a step of $\frac{1}{2}$ nsec rise time is less than 8%.

Sync Probe

The 10200B (use with any trigger function) increases input impedance to more than 750 ohms, ac coupled; reduces sensitivity by approximately 4:1 at 10 mc and higher and by approximately 20:1 at low frequencies.

Sync Pulse Output

Amplitude: Positive. At least 1.5 v into 50 ohms.

Rise Time: Less than 2 nsec.

Width: Approximately 5 μ sec.

Recurrence: One pulse per sample.

General

Calibrator:

Voltage: 20 mv, 100 mv, 200 mv and 1000 mv; $\pm 3\%$.

Time: Approximately 5 μ sec burst of 50 mc sine wave. Frequency accuracy $\pm 2\%$.

X-Y Recorder Output: X- and y-axis signals are available at rear terminals in all positions of the Scanning Control. In the Manual and Record positions the voltage can be used to make pen recordings with a conventional x-y recorder.

Horizontal Output: Approximately 0 v at start of sweep to $+13$ v at end of sweep (1.2 v/cm). Source impedance approximately 20,000 ohms.

Vertical Output: Approximately $+1$ v at top of graticule, -1 v at bottom (0.2 v/cm). Source impedance approximately 10,000 ohms.

Cathode Ray Tube: *hp* 3 kv mono-accelerator CRT with P2 phosphor. Other phosphors are optional.

Internal Graticule (Standard): Graticule in same plane as phosphor eliminates parallax. 10 cm x 10 cm, major axes and 1st and 9th cm lines (10% and 90%) have 2 mm subdivisions.

Power: 115 or 230 volts $\pm 10\%$. 50 to 60 cps, approx. 300 watts.

Dimensions: Cabinet: 14 $\frac{3}{8}$ " high, 19" wide, 22 $\frac{1}{8}$ " deep. Rack Mount: 12 $\frac{1}{4}$ " high, 19" wide, 21" deep behind panel.

Weight: Net, 75 lbs. Shipping, 99 lbs.

Accessories Furnished: 10200B Sync Probe.

Price: *hp* 185B (cabinet) or 185BR (rack mount), \$2300 (vertical plug-in required).

Options (no extra charge):

01. P1 in lieu of P2 phosphor (not available with internal graticule CRT).
05. External graticule CRT in lieu of internal graticule CRT.
07. P7 in lieu of P2 phosphor.
11. P11 in lieu of P2 phosphor.
31. P31 in lieu of P2 phosphor (not available with external graticule CRT).

PLUG-INS FOR 185B OSCILLOSCOPE

hp 187B Dual Trace Amplifier

Model 187B Dual Trace Amplifier provides over 1000 mc bandwidth while maintaining high input impedance for accurate circuit probing. These compact probes are arranged for easy application to the circuit under test with an input impedance of 100,000 ohms shunted by 2 picofarads for minimum loading. Normal input is through a small probe pin in conjunction with a spring-loaded ground pin. Probe adapters are available and a special 50-ohm tee can be used to view signals on coaxial lines.

A maximum sensitivity of 4 mv/cm facilitates measurements of small signals while a wide dynamic range permits viewing millivolt disturbances on 2 volt pulses. Where less sensitivity is desired the *hp* 10202B 10:1 Divider Probe and 10203A 100:1 Divider are available to extend the maximum signal level to 2 v/cm and 20 v/cm respectively and to increase input impedance.

Simultaneous sampling of the two channels permits accurate time comparisons between events viewed on Channel A and events viewed on Channel B. The trace is time-shared in such a way that there is no reduction in the rate of information presentation and a minimum loss of brightness when shifting from single- to dual-channel operation. The scope also can be used to view differential signals, facilitating analysis of signals containing common mode elements.

Specifications **hp** 187B

Vertical (Dual Channel)

Rise Time: Less than 350 psec using a Model 10204B 50-ohm Tee connector in a 50-ohm system. (Pass Band: dc to greater than 1000 mc.)

Overshoot or Undershoot: Less than 5%.

Sensitivity: Calibrated ranges from 10 mv/cm to 200 mv/cm in 1, 2, 5 sequence. Vernier control provides

continuous adjustment between ranges and increases maximum sensitivity to 4 mv/cm.

Attenuator Accuracy: $\pm 3\%$.

Noise: Approximately 2 mv p-p, reduced by approximately 5:1 in smoothed (noise-compensation) position of response switch.

Input Impedance: 100K shunted by 2 pf, nominal.

Power: Supplied by *hp* 185B.

Weight: Net 5 lbs. (approx.). Shipping 14 lbs.

Accessories Furnished: *hp* 10207A BNC Adapter, 2 supplied. *hp* 10206A Type N and Probe Adapter, 2 supplied. 187B-21A-11 Probe Sleeve, 2 supplied.

Price: \$1000.

hp 186A Switching Time Tester

Description

The *hp* 186A Switching Time Tester, used with the *hp* 185A,B Sampling Oscilloscopes, provides a visual display of transistor, diode, and tunnel diode switching characteristics, and also permits use of the 185 as a general purpose, single channel sampling oscilloscope. It is actually four instruments in one: a driving pulse generator with a rise time of less than 1 nsec, a sensitive (10 mv/cm) viewing channel for the 185A,B Oscilloscopes, and two bias supplies for the component or circuit under test.

This plug-in permits exact measurement of transistor rise and fall times, diode forward switching and reverse recovery times and tunnel diode switching times on the 10 cm x 10 cm display of the 185A,B Oscilloscopes. The high rep rate built-in pulse generator (up to 50 kc) insures that the display will

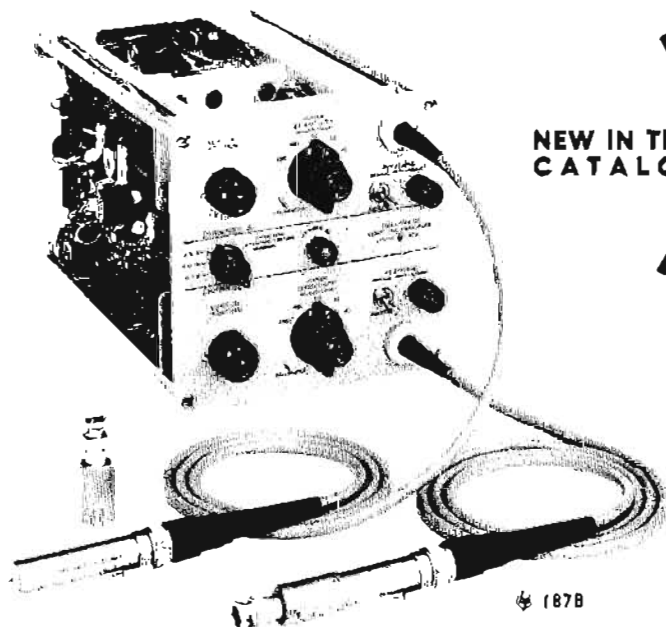

NEW IN THIS
CATALOG

hp 187B

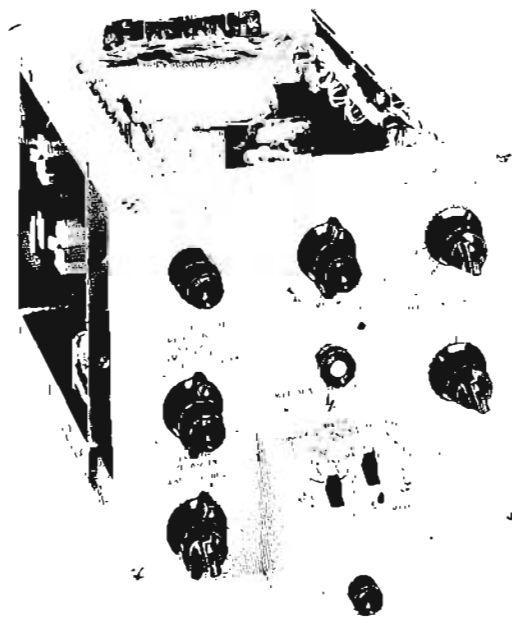

Figure 1. *hp* 186A Switching Time Tester with the Test Board Adapter and Transistor Test Board in position.

be continuous and flicker-free. A low noise level of less than 3 mv further increases the accuracy and convenience of measurements.

A number of test boards attach to the adapter in the plug-in and adapt the *hp* 186A for almost any switching element or network test. These boards simply slip into place so that the test setup may be changed in seconds. Furthermore, the circuit components may be easily changed for special applications.

Specifications *hp* 186A

Pulse Generator

Rise Time: Less than 1 nsec.

Fall Time: Less than 3 nsec for 0.2 μ sec pulse; less than 4 nsec for 1 μ sec pulse.

Overshoot and Ringing: Less than 10% peak-to-peak.

Width: 0.2 μ sec or 1 μ sec, switch selected (set at factory; each is adjustable from approximately 0.2 μ sec to 1 μ sec internally).

Amplitude: 0.1 v to 20 v peak into 50 ohms, in a 1, 2, 5, 10 sequence, either polarity.

Output Impedance: 50 ohms, except on 20 v range.

Repetition Rate: Approximately 5 kc to 50 kc, continuously variable.

Trigger Out: Triggers the *hp* 185A,B Oscilloscopes approximately 120 nsec in advance of the pulse output.

Vertical Amplifier Channel

Sensitivity: 10 mv/cm to 10 v/cm, in a 1, 2, 5, 10 sequence; vernier provides continuous adjustment between steps and increases maximum sensitivity to 4 mv/cm.

Rise Time: Less than 0.5 nsec.

Overshoot: Less than 5%.

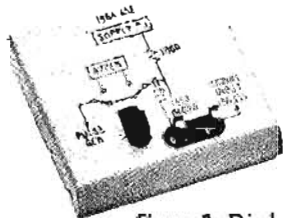

Figure 2: Diode Test Board. The Diode Test Board (Figure 2) and the Tunnel Diode Test Board (Figure 3) incorporate a 100 ohm loop impedance configuration.

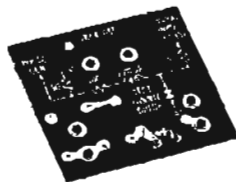

Figure 3: Tunnel Diode Test Board.

Noise: Less than 3 mv.
Input Impedance: 50 ohms.

Bias Supplies

Supply No. 1 (Emitter-Collector): \pm 30 v; 50 ma maximum average current (1 amp peak with 5% duty cycle).

Supply No. 2 (Base-Emitter): 0 to \pm 10 v, referable either to ground or to the emitter-collector supply voltage; 10 ma maximum average current (0.2 amp peak with 5% duty cycle).

Accessories Furnished (See Figure 1).

Test Board Adapter.

Transistor Test Board.

Diode Test Board (see Figure 2).

Tunnel Diode Test Board (see Figure 3).

Pulse Test Board (for observing the *hp* 186A output pulse).

Sync Cable, *hp* 10121A, 8" BNC-to-BNC, 50-ohm.

Accessory Case.

Accessories Available

Model 10225A Universal Adapter (for circuit tests, see Figure 4), \$45.

Model 10227A Extender cable for remote operation of Adapter and Test Board. Price, \$50.

General

Power: Provided by *hp* 185A,B Oscilloscopes.

Weight: Net 5 lbs. Shipping 13 lbs.

Price: \$1500.

Data subject to change without notice.

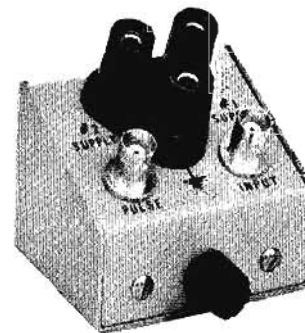
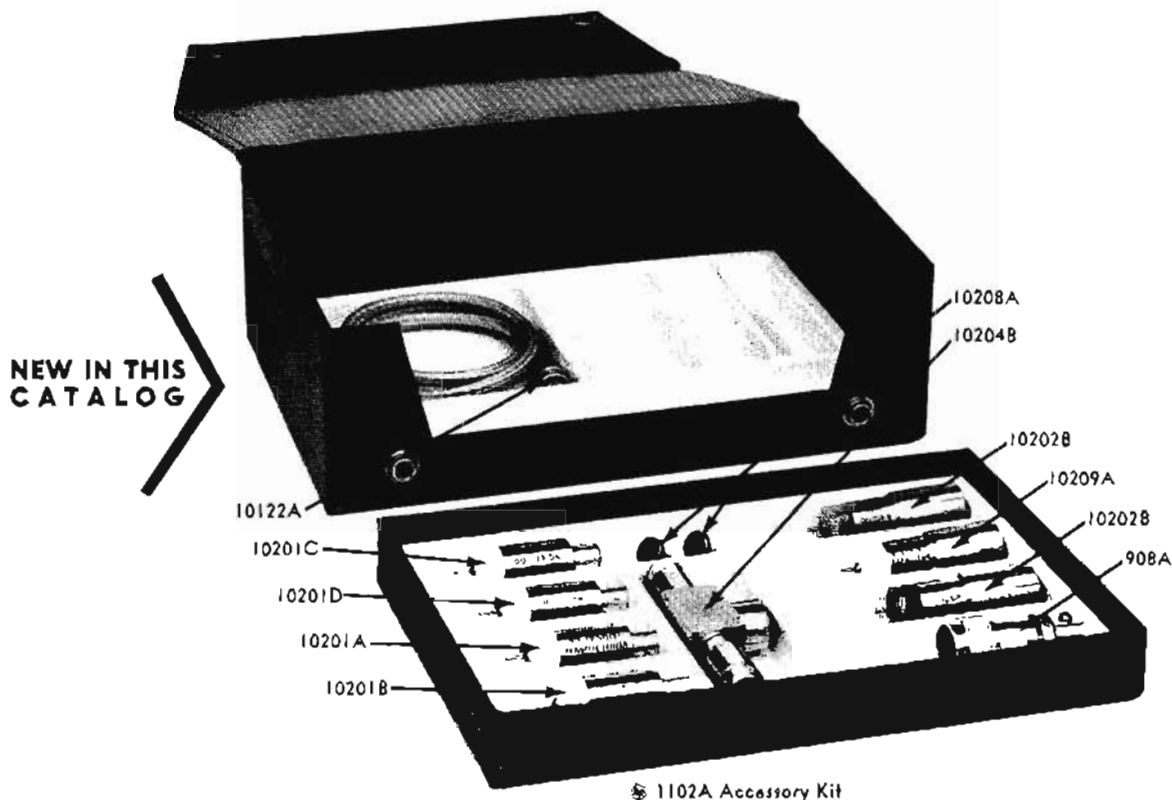

Figure 4: Universal Adapter. For circuit and network tests the Universal Adapter is available. The Universal Adapter brings the biasing voltages, the output pulse, and the input of the *hp* 186A to convenient terminals for connection to the network under test. With this adapter, for example, the pulse response of amplifiers, blocking oscillators, and filters may be studied conveniently. For circuit probing and higher input impedance resistive divider probes are available.

ACCESSORIES FOR THE 185B OSCILLOSCOPE



1102A Accessory Kit

The 1102A Accessory Kit increases the convenience and performance of the 185B Oscilloscope by providing, in a handy container, the extra accessories that are commonly needed. These accessories allow you to measure larger signals, sample 50-ohm systems and reduce circuit loading. The accessories are packaged in a convenient box which has adequate extra space for the accessories furnished with the oscilloscope. Included in the kit are:

- 1 — *hp* 908A Termination
- 1 — *hp* 10122A Cable Coaxial Type N male to BNC female
- 1 — *hp* 10201A 5:1 Resistive Divider
- 1 — *hp* 10201B 10:1 Resistive Divider
- 1 — *hp* 10201C 50:1 Resistive Divider
- 1 — *hp* 10201D 100:1 Resistive Divider
- 2 — *hp* 10202B 10:1 Dividers
- 1 — *hp* 10204B 50-ohm Tee
- 2 — *hp* 10208A Blocking Capacitors (0.001 μ f)
- 1 — *hp* 10209A Blocking Capacitor (0.1 μ f)

A description of the individual kit components follows. Details on the use of these accessories are presented in *hp* Application Note 44D, "Sampling Oscilloscope Accessories and How to Use Them."

Price: *hp* 1102A Accessory Kit, \$300.

908A Coaxial Termination

Model 908A 50-Ohm Coaxial Termination is a low-power termination for 50-ohm transmission lines. Its SWR is 1.05 or less at any frequency from dc to 4000 mc. Maximum dissipation is $\frac{1}{2}$ watt. The 908A has a Type N male fitting, is 2" long and weighs 3 ounces. Also sold separately. Price, \$35.

10122A Cable

The 10122A Cable is a high quality flexible 36" length of 50-ohm $\pm \frac{1}{2}$ ohm coaxial cable with male BNC and Type N connectors for use with the series resistive dividers in circuit probing applications. Also sold separately. Price, \$10.

10201A,B,C,D Resistive Divider Probes

These dividers provide a high impedance low capacitance input for the Model 1100A Delay Line and other 50-ohm systems. When used with the flexible *hp* 10122A Cable, these small, lightweight resistive dividers represent a very convenient means for routine circuit probing. The four probes produce a signal division of 5, 10, 50 and 100 when terminated with a 50-ohm system. Shunt capacitance is low, with the result that input impedance at high frequencies is greater than the input impedance of the regular oscilloscope probes.

Specifications

Model	Input Resistance (ohms) ¹	Division Ratio ¹	Division Ratio with <i>hp</i> 10205A	Max. Input (vrms) ²
10201A	250	5:1	10:1	10
10201B	500	10:1	20:1	15
10201C	2500	50:1	100:1	35
10201D	5000	100:1	200:1	50

¹When terminated in 50 ohms.

²Limited by the power dissipation of the resistive element.

Input Capacitance: 0.4 pf.

Price: \$40 each, when sold separately.

10202B 10:1 Divider

This 10:1 divider permits you to observe signals as large

as 20 volts peak-to-peak and increases the impedance of the 187B probe to 1 megohm shunted by 2.5 pf. The divider merely slides over the end of the probe so that its small dimensions are preserved. Many of the other 187B accessories, such as BNC or Type N adapters and blocking capacitor, will fit onto this divider. Also sold separately. Price, \$40.

10204B 50-Ohm Tee Connector

The 10204B 50-Ohm Tee Connector may be inserted into a 50-ohm transmission line so that you may monitor the signal on the line using the oscilloscope probe. This is particularly important when observing reflections to determine cable impedance or evaluate coaxial connectors. Insertion loss (mismatch loss + attenuation) is low so that the tee (with the probe inserted) does not disturb the line or appreciably attenuate the signal being transmitted. The Tee connector and low reflection load such as the hp 908A may be used to terminate the 50-ohm line in its characteristic impedance while observing the signal with the oscilloscope. The 10204B has two female Type N fittings. The reflection from a step input in a 350 psec rise time system from the Model 10204B is a 500 psec wide inverted pulse that is no greater than 25% of the input step height. Also sold separately. Price, \$40.

10208A Blocking Capacitor

This blocking capacitor may be used with the signal probe or with the probe and Model 10202B 10:1 Divider so that you can observe signals that are 600 volts from ground. The blocking capacitor contributes only 1% sag to a 1 μ sec pulse when used with the probe alone, 0.1% sag when used with the 10:1 divider. No more than 0.5 pf shunt capacitance is added to the input by the blocking capacitor. The 10208A may also be used with the hp 10207A BNC Adapter. Also sold separately. Price, \$3.50.

10209A Blocking Capacitor

This blocking capacitor may be used to observe relatively long pulses and signals up to 200 v above ground. The blocking capacitor slips over the 187B probe and when used in this manner contributes less than 1% sag to a 100 μ sec pulse. The Model 10209A may also be used with the 10202B 10:1 Divider (where sag will be less than 0.1% for a 100 μ sec pulse) or with the resistive dividers. When used with the resistive dividers the time for 1% sag is:

Model	Division Ratio	Input Resistance (ohms)	Time for 1% Sag (μ sec)
10201A	5:1	250	0.25
10201B	10:1	500	0.5
10201C	50:1	2500	2.5
10201D	100:1	5000	5

The 10209A Blocking Capacitor introduces negligible distortion when used to view signals which have a rise time of 1 nsec or longer. It adds no more than 3.5 pf shunt capacity to the input. Also sold separately. Price, \$27.

Special-Purpose Accessories

Also available separately are several special-purpose accessories.

10203A 100:1 Divider

This 100:1 divider may be used to reduce signal levels as high as 200 v to the ± 2 v dynamic range of the 187B. The 10203A offers less than 1 pf shunt capacity and 10 megohms shunt resistance to the circuit under test. This attenuator may be used in conjunction with other sampling accessories such as blocking capacitors, 50-ohm tee and BNC adapter for maximum versatility. Price, \$40.

10210A Probe Socket

These probe sockets may be mounted over test points on printed circuit boards to guide the 187B probe quickly onto the proper test point and to provide solid ground reference. This accessory makes for faster, more efficient routine circuit checks, as well as more efficient production test procedures. Price, \$2.

1100A DELAY LINE

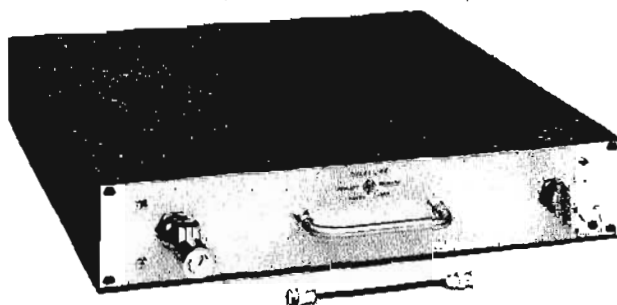

1100A Delay Line

The hp 1100A Delay Line with its accessories lets you view signals, where suitable triggers are not available separately, by providing a delay between the trigger input and the vertical channel input. Accessories furnished with the 1100A include a Sync Take-Off, which splits the input signal into two parts; a Delay Line Load, which terminates the delay line and provides a connection for the vertical amplifier input probe; and a Sync Cable, which connects the sync signal from the Sync Take-Off to the oscilloscope.

The Delay Line Load compensates for high frequency losses in the coaxial line so that overall rise time of the 187B and the 1100A remains virtually the same for signals with rise times slower than 0.5 nsec. There is less than a 10% increase in rise time even when signals having a rise time of 0.5 nsec are viewed. When the Sync Take-Off is used all 187B sensitivity settings are merely multiplied by 2 to regain accurate vertical calibration.

The 1100A is available in either bench or rack mount styles. The bench style is the same width and depth as the 185B and is constructed so the 185B will rest securely when placed on top.

Specifications

Rise Time: Approximately $\frac{1}{4}$ nsec.

Delay: 120 nsec.

Overshoot: Increases overshoot in a 0.5 nsec rise time signal less than 2%.

Input Impedance: 50 ohms.

Connectors: Type N female input, Type N male output.

Accessories Furnished: Model 10205A Sync Take-Off, Model 10121A Sync Cable and Model 10212A Delay Line Load.

Dimensions: Cabinet: 19 $\frac{1}{8}$ " wide, 4" high, 22 $\frac{3}{4}$ " deep; Rack mount: 19" wide, 3 $\frac{1}{2}$ " high, 22 $\frac{3}{4}$ " deep.

Weight: Net, 29 lbs. Shipping, 45 lbs.

Price: hp 1100A (cabinet) or 1100AR (rack mount), \$300.

Available Separately: Model 10205A Sync Take-Off, \$50. Model 10212A Delay Line Load, \$50.

OSCILLOSCOPE PHOTOGRAPHY

Oscilloscope cameras produce permanent records of oscilloscope displays for use in engineering reports or in other situations where pictures of waveforms facilitate discussion and analysis. Furthermore, oscilloscope cameras can photograph single transients and other phenomena which are too short-lived for the eye to see.

Polaroid® Land film is widely used in scope photography, primarily because the finished print may be examined shortly after the exposure is made. This "quick check" makes it easy to find the optimum camera and oscilloscope control settings, thus assuring satisfactory photos in short order.

Oscilloscope Cameras

Oscilloscope cameras are similar to conventional cameras but have additional refinements for facilitating scope photography. The camera is within a light-tight enclosure which clamps or bolts over the face of the cathode ray tube, preventing external light from "washing out" the CRT trace. Doors on the enclosure provide access to shutter and lens controls (the shutter trip is operated externally).

In the Hewlett-Packard 196 series cameras, the optical system is in line with the axis of the CRT (No mirrors means no inversions). A viewing port wide enough for "two-eye" viewing permits observation of the displayed waveform. The port has a face-fitting vinyl hood for preventing light leakage around the eyes.

Special Fixed-Focus Lens

The six-element, fixed-focus lens of the Hewlett-Packard cameras was designed especially for oscilloscope use. The lens eliminates the barrelling and pin-cushioning effects so often encountered in similar close-up situations, insuring accurate reproduction of oscilloscope traces. This is demonstrated by the linearity of the graticule lines in Figure 1. Accurate scale measurements of photos made with these cameras are possible, especially when the cameras are used in conjunction with Hewlett-Packard's internal graticule cathode ray tubes. (The internal graticule tube completely eliminates any inaccuracies commonly caused by parallax between the trace and an external graticule.)

The lens of the Hewlett-Packard 196 Series Cameras moves vertically through 11 detented positions, allowing several traces to be photographed on one film without disturbing the position of the CRT trace. The shutter and iris systems are identical in operation to conventional cameras.

Graticule Illumination

A new technique which enhances the quality of scope photos is available with the Hewlett-Packard 196B camera. This camera has a low-power ultraviolet (UV) light for delineation of the black graticule in Hewlett-Packard internal graticule CRT's. The UV light causes the CRT phosphor to glow uniformly over its entire surface, this glow appearing as an intermediate gray in the finished picture. The gray background sharply contrasts the white trace with the black graticule lines, making oscillograms taken with this camera easier to interpret. Figure 2 shows the improvement in photographic quality obtained with the ultraviolet light.

The ultraviolet light also obtains a two-fold increase in film speed by generating an effect equivalent to "pre-fogging" of the film at the same time that the picture is taken. Ordinarily, a single, faint

trace may not expose the film sufficiently to bring the density level above the brightness threshold level (the "toe" of the density/exposure curve as shown in Figure 3). The gray background provided by the UV light, however, moves the trace's "zero" exposure level into the gray region, where a slight increase in exposure, caused by the trace, becomes visible.

Making Oscilloscope Photos

Many variables must be accounted for in making oscilloscope photos. Initial attempts involve cut-and-try procedures, first-time procedure usually going as follows:

The CRT trace intensity is adjusted so that fast transients in the waveform almost disappear (trace contrast actually photographs brighter than it appears to the eye); CRT focus is adjusted for the finest trace. The UV light is adjusted for a visible phosphor glow.

For steady waveforms, a relatively long exposure and a small iris opening are recommended, e.g., 1/2 second at $f/11$. As in other types of photography, a small iris opening (large f -number) is preferred for best overall photographic quality.

Subsequent trial photographs are optimized by adjusting the f -stop or exposure time. The trace should photograph completely white (sufficient exposure) without blooming or broadening (over-exposure). Some compromise may be necessary on complex waveforms, either by increasing exposure to capture fast-rising transients, or decreasing exposure to preserve detail in slower moving parts of the waveforms. Finally, the ultraviolet light is readjusted to bring the background to the desired shade of gray.

If the waveform is unstable or noisy, exposure time is reduced to capture fewer trace repetitions, and the f -number is decreased accordingly.

Single-Trace Photography

Single-trace photography of fast transients is possible with the sensitive films now available, these films being able to capture single events which are too fast and faint for the eye to notice. Polaroid® type 47 film (ASA 3000), currently preferred for most types of scope photography, is well-suited for single trace photography, while type 410 (ASA 10,000) is used for exceptionally fast or faint traces.

In single-trace photography, the oscilloscope initially should be set up using a pulse generator operating at a low repetition rate (30 cps or less) as a test signal. The low repetition rate avoids the increase in trace brightness caused by phosphor persistence when traces overlap and permits optimum CRT focus adjustment. During this initial adjustment, the sweep speed should be set on the same speed to be used in the final picture. To make the photograph of the desired transient, the camera shutter is held open manually on Bulb or Time while the oscilloscope sweep is triggered once by the signal being photographed.

To include graticule information in a single-sweep photo, the graticule, whether edge-lighted or UV-lighted, should be captured during a separate timed exposure with no trace. The trace then is photographed during a second exposure with the graticule light turned off.

One further precaution regarding external graticules concerns parallax between the trace and graticule; allowance for parallax should be made when adjusting trace height and position. Parallax is not present, though, if an internal graticule CRT is being used.

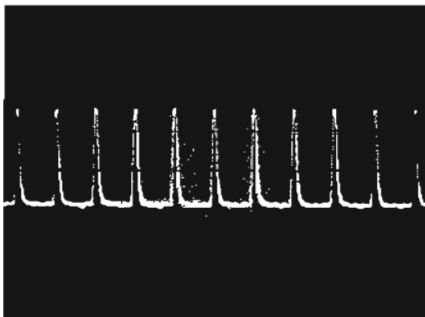

Figure 1. Photo made with hp 196B Camera shows retention of graticule linearity throughout usable area.

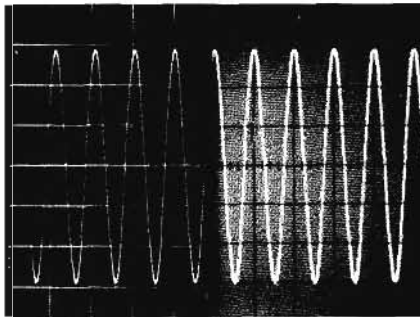

Figure 2. "Half-and-half" photo made with special cathode ray tube compares photographic qualities of conventional external graticule and UV-lighted internal graticule.

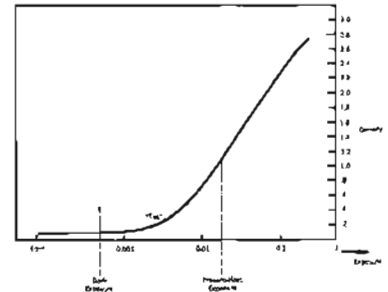
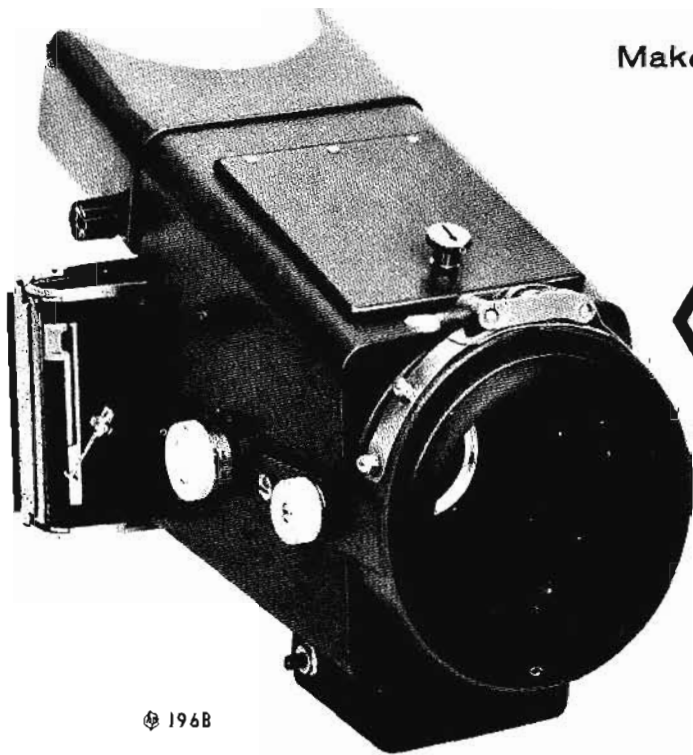

Figure 3. Typical density/exposure curve of photographic film shows how "pre-fogging" (presensitizing) moves exposure level into region of maximum sensitivity.

196A, B OSCILLOSCOPE CAMERAS

Make Distortionless Scalable Photographs



NEW IN THIS
CATALOG

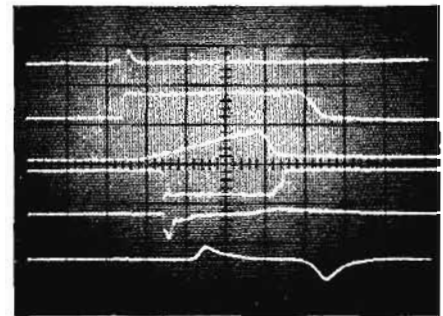

A multi-exposure photograph of related signals made with the  196B

Advantages:

- Three shade photograph for maximum readability
- Increased film sensitivity
- Distortionless scalable photos
- Up to 11 exposures on one print
- Finished print in 10 seconds

The *hp* Model 196B Oscilloscope Camera, specifically designed for photographing traces on Hewlett-Packard oscilloscopes equipped with the internal graticule CRT, provides clearer, more accurate oscilloscope photos. The three shade photo permits more accurate measurements since the black graticule lines on the internal graticule tube are clearly separated from the white trace. Also, when used with the *hp* internal graticule CRT the photos are completely free of parallax. Photographs of old style, external graticule CRT's exhibit as much as 5% parallax error.

Included in the 196B is an ultraviolet light which causes the phosphor to glow gently — generating an intermediate gray background in the finished photo. Resulting photographs are far easier to read since excellent contrast is obtained between the gray background, white trace and black graticule. In addition, the "fogging" of the background causes an increase in film sensitivity and writing rate which permits clearer, sharper photos of dim traces. The light source is also useful for prefogging film to provide added film sensitivity for capturing single transients.

The 196B oscilloscope camera mounts on the oscilloscope with a quick acting one hand clamp and has a vinyl viewing hood that permits viewing the trace without disturbing the camera's settings or position. In addition, it is prefocused to eliminate the need for complicated adjustments and attachments. A specially designed lens eliminates distortion; both barrel and pin cushion are imperceptible. The field of focus is flat and pictures are sharp, clean and easy to read.

A convenient forward access port allows adjustment of shutter speed, diaphragm settings and ultraviolet light level with the camera in place. Eleven detented vertical positions simplify multiple exposures and are controlled from one external knob. The camera is equipped with the Polaroid® Land back which gives finished photos in 10 seconds.

Although designed for photographing the *hp* internal graticule CRT, the camera may also be used for photographing the old style external graticule CRT's. Model 196A, without an ultraviolet light source, but otherwise identical to Model 196B, is available for use on external graticule CRT's.

Specifications

- Object-to-Image Ratio: 1:0.9; 1:1 available.
- Lens: 3" (75 mm), *f*/1.9.
- Focus: Adjustable; factory set for optimum resolution of both trace and graticule.
- Lens Opening: *f*/1.9 to *f*/16.
- Shutter Speeds: 1/100, 1/50, 1/25, 1/10, 1/5, 1/2, 1 sec, Time, Bulb.
- Print Size: 3 1/4" x 4 1/4".
- Image Size: 2 7/8" x 3-13/16" (7.3 x 9.6 cm).
- Film: Polaroid® Land film, types 42, 56, 46-L, 47 and 410.
- Dimensions: 13 1/2" long, 10 1/4" high, 10" wide.
- Weight: Net 9 lbs. Shipping 18 lbs. (32 lbs. with carrying case).
- Power: 196B: 115 v ± 10%, 60 cps, 10 watts.
- Accessories Available: *hp* 10350A Adapter for Tektronix Oscilloscopes, \$4.50; *hp* 10351A Carrying Case, \$40.
- Price: *hp* 196B, \$445; *hp* 196A, \$395.
- Options Available: Option 12: 196B modified for 115 v or 230 v, 50 cps operation, add \$15.

®Polaroid Corporation

Data subject to change without notice.

hp CURRENT PROBE AND AMPLIFIER

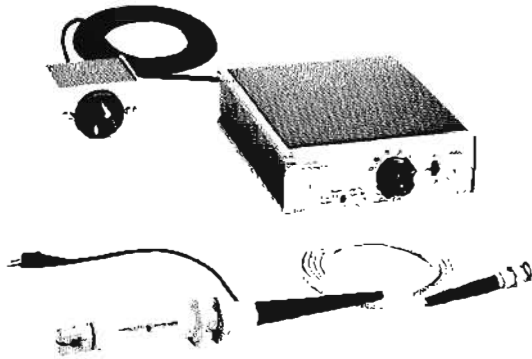

⊕ 1110A Probe shown with 1111A Current Amplifier

Advantages:

- Measures ac currents up to 50 amps peak-to-peak
- Wide bandwidth, clean pulse response
- Clamp-on probe, no direct circuit connection
- Probe may be used with or without 1111A Amplifier
- Introduces negligible loading on test circuit
- 50-ohm output impedance for remote sensing

Uses:

- Observe fast rise time ac current waveforms
- Measure current waveforms in tube and transistor circuits
- Measure turn-on surge of motors and other high current devices
- Observe phase between voltage and current

With the *hp* 1110A and 1111A Current Probe and Amplifier you can observe fast rise, ac current waveforms over the wide range of 1 ma/cm to 5 amps/cm on any wide-band oscilloscope without breaking circuit leads and without circuit loading. The Model 1110A Probe may be used by itself, giving a sensitivity of 1 mv/ma with a rise time of 7 nanoseconds, a bandwidth of 50 mc. The Model 1111A AC Current Amplifier increases the 1110A Probe's sensitivity and extends low frequency response, providing an overall rise time of 18 nanoseconds (20 mc).

The unique probe design brings "clamp and read" convenience to ac current measurements. The probe merely clamps around the current-carrying wire and provides a voltage output proportional to the current. Current measurements can be made even in the presence of high voltage, since no connection is required. Model 1111A Current Amplifier is calibrated so that its output voltage is 50 mv for 1 ma through the probe. Hence, when used with a 50 mv/cm sensitivity oscilloscope, the Model 1111A indicates directly in ma/cm, thus eliminating cumbersome conversion factors. Because direct currents up to 1/2 ampere have no appreciable effect on the operation, you may measure ac currents in logic circuits, transistors and vacuum tubes even though these ac currents are superimposed on dc currents.

Specifications, 1110A and 1111A

- Sensitivity:** 1 ma/cm to 50 ma/cm in a 1, 2, 5 sequence in x1 and 100 ma/cm to 5 a/cm in x100; when used with an oscilloscope at 50 mv/cm sensitivity.
- Accuracy:** ± 3% on 50 ma/cm sensitivity and below. ± 4% on 100 ma/cm sensitivities and above.
- Bandwidth:** 35 cps to 20 mc (18 nsec rise time).
- Noise:** Less than 100 μa peak-to-peak referred to input.
- Maximum AC Current:** 50 amps peak-to-peak above 700 cps decreasing at the rate of 1.4 a/20 cps at lower frequencies.

hp TESTMOBILES

Advantages:

- Adjusts for best viewing angle
- Storage for plug-ins and accessories

The *hp* 1115A and 1116A Testmobiles provide easy, convenient portable use of oscilloscopes or other equipment. The Model 1115A accepts instruments up to 17 inches wide, such as the 120B, 130C, 140A and 175A, while the *hp* 1116A is used with wider instruments (up to 20 1/2") such as *hp* 160B, 170A, 185B, 524C and 524D.

The testmobiles have four-inch-diameter wheels for easy rolling even over rough surfaces. Toe-operated locks on the front two wheels anchor the testmobile firmly in place. Also, a storage compartment in the *hp* 1115A and storage tray in the *hp* 1116A keep accessories and several oscilloscope plug-ins handy for quick use.

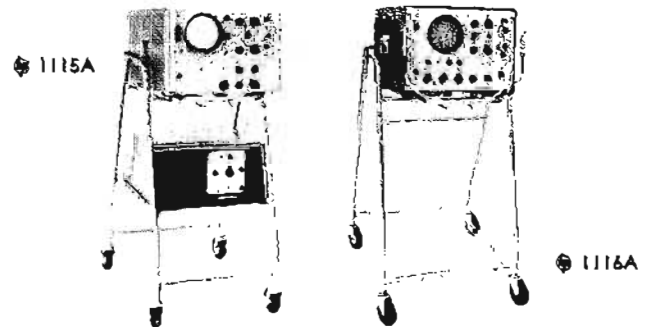

Specifications, 1115A

- Will accept instruments up to 17" wide such as *hp* 120B, 130C, 140A, 175A Oscilloscopes.
- Viewing Angle:** Adjustable in 5° increments covering 10° below horizontal to 20° above horizontal.
- Dimensions:** Approximately 38" high, 27" deep, 22 3/4" wide.
- Weight:** Net 40 lbs. Shipping 46 lbs.
- Price:** \$115.

Specifications, 1116A

- Use with instruments up to 20 1/2" wide such as Models 160B, 170A, 185B Oscilloscopes and 524C, 524D Electronic Counters.
- Viewing Angle:** From horizontal to 30° above horizontal in 7 1/2° steps.
- Dimensions:** Approximately 45" high, 18" deep, 26 1/4" wide.
- Weight:** Net 39 lbs. Shipping 45 lbs.
- Price:** \$85.

Output Impedance: 50 ohms.

Dimensions:

Amplifier: 1 1/2" high, 5 1/8" wide, 6" deep.

Probe: Aperture 5/32" dia., 5 ft. cable.

Weight: Net, 2 lbs. Shipping, 3 lbs.

Power: 115 or 230 v ± 10%, 50 to 400 cps, approximately 1.5 watts.

Price: 1111A Amplifier, \$160. 1110A Current Probe, \$100.

1110A Current Probe Only

Sensitivity: 1 mv/ma.

Accuracy: ± 3%.

Bandwidth: 1700 cps to greater than 50 mc (7 nsec rise time) with 4 pf load (185B, 187B), decreasing proportionately to 40 mc (9 sec rise time) with a 30 pf load (175A, 1750A).

Maximum DC Current: 0.5 amp.

Maximum AC Current: 15 amps peak-to-peak above 4 kc decreasing at the rate of 3.8 amps per kc at lower frequencies.

Insertion Impedance: Probe reflects approximately 0.01 ohm shunted by 1 μh into test circuit. Shunt capacity to ground is less than 3 pf.

Accessories Available: *hp* 10100B 100-ohm feed-through termination. Decreases sensitivity to 0.5 mv/ma and lower cut-off to 850 cps, increases maximum ac current to 30 amps peak-to-peak above 4 kc.

PROBES, VIEWING HOODS, ADAPTERS, SERVICE ACCESSORIES



10003A

A complete series of slim pen-style voltage divider probes provides convenient circuit probing. The high impedance input of the probes reduce loading of oscilloscopes on the circuit under test, and the probes provide attenuation for large signals. The probes may be quickly and accurately compensated for optimum step response with a simple adjustment on the probe barrel; price \$30 each.

Probe	Atten.	Bandwidth (0.5 db)	Resistance (Meg-ohms)	Capacitance	Div. Accuracy	Peak Input Volts	Approx. Overall Length	Approx. Rise Time
10001A	10:1	dc to 30 mc	10	10 pf	2%	500	5'	5 nsec
10001C*	10:1	dc to 30 mc	10	10 pf	2%	400	5'	5 nsec
10001B	10:1	dc to 30 mc	10	20 pf	2%	500	10'	5 nsec
10001D*	10:1	dc to 30 mc	10	20 pf	2%	500	10'	5 nsec
10002A	50:1	dc to 30 mc	9	2.5 pf	3%	1000	5'	5 nsec
10002C*	50:1	dc to 30 mc	9	2.5 pf	3%	1000	5'	5 nsec
10002B	50:1	dc to 30 mc	9	5 pf	3%	1000	10'	5 nsec
10002D*	50:1	dc to 30 mc	9	5 pf	3%	1000	10'	5 nsec
10003A	10:1	dc to 40 mc	10	10 pf	2%	500	4'	3 nsec
10003B*	10:1	dc to 40 mc	10	10 pf	2%	500	4'	3 nsec

*These probes have black identification boots; the others have red boots

Voltage Divider Probe Tips

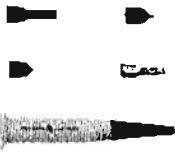

10035A Probe Tip Kit

Provides maximum versatility when used with the voltage divider probe. The kit contains a pincer jaw, banana tip, pin tip, hook tip and spring tip. The pincer jaw is a rugged, positive gripping tip for use in areas with limited access. The banana tip provides connector convenience and ruggedness for monitoring signals on binding posts. Pin tip and hook tip are provided for circuit probing and a spring tip is furnished to monitor signals on multi-pin connectors. Price \$5.



10010C

The BNC tip allows monitoring of signals at front panel BNC connectors; price, \$10.

General Purpose Probe

The hp 10025A is a thin, flexible probe with pushbutton pincer jaws which provides a straight-through connection to voltmeters, ohmmeters and oscilloscopes. Its extremely small size makes it ideal for connecting to wires, tie points and tube sockets. Maximum input voltage is 600 volts peak, and the shunt capacity is approximately 150 picofarads. The cable is terminated in a shielded dual banana plug; price \$9.

Polarized Viewing Hood



The Model 10175A Polarized Viewing Hood provides easy viewing of dim traces under all ambient light conditions. A polarized light filter within the viewing hood increases trace to background contrast and minimizes glare and reflections. It is ideal when more than one person is observing the CRT; price \$10.

Viewing Hood



The Model 10175B Viewing Hood is ideal for viewing fast transients since it is equipped with a face fitting vinyl mask. The mask may be removed from the tubular section if desired; price \$7.

Adapters

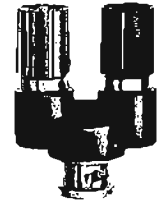

The Model 10110A Adapter (BNC male to dual banana post) quickly converts standard BNC input terminals on oscilloscopes to dual banana posts; price \$5.

The hp Model 10111A Adapter (shielded banana post to female BNC) converts banana post inputs on oscilloscopes to shielded BNC inputs for low level signal work. This adapter may be used in pairs for balanced input characteristics; price \$7.

10400B, 10401A, 10402A

Plug-In Extenders



10400B, 30" extension cable for 160B, 170A, 175A vertical plug-ins; price \$25. 10401A, extension frame for 185A,B plug-ins; price \$35. 10402A, 24" extension cable for 160B, 170A, 175A time axis plug ins; price \$35.

10403A Alignment Attenuator

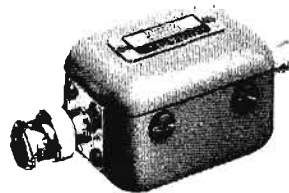

The 10403A Alignment Attenuator may be used to check and adjust the input capacity of the hp 1750A Vertical Amplifier. The alignment attenuator is factory set for the input capacity of the hp 1750A (28 pf); an internal adjustment, however, will allow changing the capacity for use with other vertical pre-amplifiers. The adjustable range of the capacity is approximately 24 pf to 60 pf; price \$35.

10404A Vertical Test Adapter

The Model 10404A Vertical Test Adapter provides a convenient means of applying a known voltage to the main vertical amplifier of the 175A for setting the gain. The input impedance of the adapter is approximately 1 megohm and may be driven from any external calibrator or the calibrator in the 175A. A control is also provided for easy positioning of the trace; price \$15.

10405A Vertical Response Tester

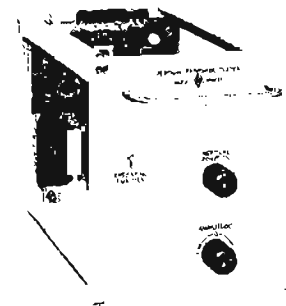

The hp 10405A Vertical Response Tester provides a fast step function for use in establishing and adjusting the "step" response of the main vertical amplifier in the 175A. This plug-in generates a positive or negative 2 v adjustable pulse with a rise time less than 1 nsec. The fast rise is accomplished through the use of a mercury switch driven at approximately 250 cps by a self-contained transistorized oscillator; price \$125.

PULSE AND SQUARE WAVE GENERATORS

Pulse and square wave generators most often are used with an oscilloscope as the measuring device. Waveform shapes as seen by the oscilloscope, either at the output or at pertinent points within a system under test, provide both qualitative and quantitative evaluations of system or device performance.

Square Waves or Pulses

The fundamental difference between pulse and square wave generators concerns the signal duty cycle. Square wave generators have equal "on" and "off" periods, this equality being retained as the repetition frequency is varied. The duration of a pulse generator "on" period, on the other hand, is independent of pulse repetition rate. The duty cycle of a pulse generator can be made quite low so that these instruments are generally able to supply more power during the "on" period than square wave generators. The *hp* 214A, for instance, supplies up to 200 watts in its output pulse.

Short pulses reduce power dissipation in the component or system under test. For example, measurements of transistor gain are made with pulses short enough to prevent junction heating and the consequent effect of heat on transistor gain.

Square wave generators are used where the low frequency characteristics of a system are important, such as in the testing of audio systems. Square waves also are preferable to short pulses if the transient response of a system requires some time to settle down.

Pulse Generators

In the selection of a pulse generator, the quality of the output pulse is of primary importance. High quality test pulses insure that degradation of the displayed pulse may be attributed to the test circuit alone.

The pertinent characteristics of a test pulse, shown in Figure 1, are con-

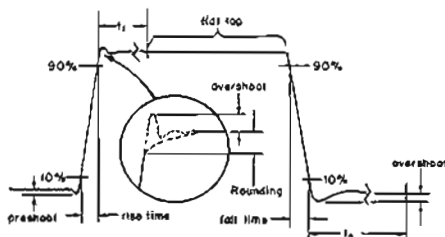

Figure 1. Test pulse description in terms of primary characteristics.

trolled and specified accurately in *hp* pulse generators. Rise and fall times should be significantly faster than the circuits or systems to be tested. Any overshoot, ringing and sag in the test pulse should be known, so as not to be confused with similar phenomena caused by the test circuit.

The range of pulse width control should be broad enough to fully explore the range of operation of a circuit. Narrow pulse widths are useful in determining the minimum trigger energy required by some circuits.

Maximum pulse amplitude is of prime concern if appreciable input power is required by the tested circuit, such as a magnetic core memory. At the same time, the attenuation range should be broad enough to prevent overdriving the test circuits, as well as to simulate actual circuit operating conditions.

The range of pulse repetition rates is of concern if the tested circuits can operate only within a certain range of pulse rates. In measurements involving nanosecond rise times where sampling scopes are most often used as the measurement instrument, the maximum repetition rate should be high enough (>30 kc) to generate a sampling rate which avoids flicker in the display.

Triggering

The trigger requirements for synchronizing a pulse generator should be evaluated in light of the triggers available in anticipated measurement setups. Late model *hp* pulse generators have versatile trigger circuits similar to oscilloscopes. These circuits synchronize on most any kind of waveform of more than 1 v amplitude, with full selection of the amplitude and slope at which triggering occurs.

Hewlett-Packard pulse generators also supply fast rise output triggers for operation of external equipment. The output triggers may be timed to occur either before or after the main output pulse.

Source Impedance

Generator source impedance is an important consideration in fast pulse systems. This is because a generator which has a source impedance matched to the connecting cable will absorb reflections resulting from impedance mismatches in the external system. Without this match, reflections would be re-reflected by the generator, resulting in

spurious pulses or perturbations on the main pulse.

DC coupling of the output circuit is necessary when retention of dc bias levels in the test circuit is desired in spite of variations in pulse width, pulse amplitude or repetition rate.

Applications of Pulse and Square Wave Generators

Pulse generators with fast rise times are widely used in the development of digital circuitry. Teamed with a suitably fast oscilloscope, these generators enable evaluation of transistor and diode switching times.

Pulse generators are used as modulators for klystrons and other rf sources to obtain high peak power while maintaining low average power. Square wave generators are used to modulate rf sources in setups using power detectors with tuned audio amplifiers. In either case, rise and fall times of the modulating waveform should be fast and the waveform top should be flat to minimize frequency "pulling".

Pulse generators also are used for impulse testing. A very short pulse is rich in harmonic frequency components, so that impulse testing amounts to simultaneous frequency response testing of components or systems.

A relatively new application of fast pulse instruments is the testing of transmission lines, discussed in more detail on page 45. Very fast pulse generators (*hp* Models 213B or 215A) used with an equally fast oscilloscope (*hp* Model 185B) can also measure the stray inductances and capacitances of components.

Tests of linear systems with pulse or square wave generators and oscilloscopes are dynamic tests which quickly analyze system performance. Because of the Fourier transform relationships between the transient response of a system and its frequency and phase characteristics, overall system response can be evaluated by observing the pulse response on an oscilloscope.

Hewlett-Packard designs pulse generators with the fast rise times, matched source impedance, flexible pulse width and amplitude control, and versatile triggering capabilities required by a wide range of laboratory measurements. Particular attention has been paid to the quality of the output pulse, with all aspects of pulse shape carefully controlled and specified in detail.

hp 211A SQUARE WAVE GENERATOR

Convenient Audio, Video Testing 1 CPS to 1 MC

Specifications

- Frequency Range:** 1 cps to 1 MC, continuous coverage.
- Low Impedance Output:** Negative 3.5 v peak across 75 ohm impedance; negative 7.0 v peak open circuit, zero level clamped to chassis. Rise time less than 20 nsec. BNC connector.
- High Impedance Output:** Negative 27 v peak across 600 ohm impedance; negative 55 v peak open circuit, zero level clamped to chassis. Rise time less than 0.1 μ sec. Dual banana jacks— $\frac{3}{4}$ " centers.
- Relative Phase:** 180° phase difference between low and high impedance output signals.
- Amplitude Control:** Low Impedance Output—potentiometer and 60 db attenuator, variable in 20 db steps. High Impedance Output—potentiometer.
- Frequency Control:** Dial calibrated "1 to 10" and decade multiplier switch. Six bands.
- Symmetry Control:** Allows exact square-wave balance.
- Sync Input:** Positive-going pulse or sine wave signal, minimum amplitude 5 volts peak. BNC connector.
- Power:** 115 or 230 v \pm 10%, 50 to 60 cps, 225 watts.
- Dimensions:** Cabinet Mount: 9 $\frac{3}{4}$ " wide, 15 $\frac{1}{4}$ " high, 14 $\frac{5}{8}$ " deep. Rack Mount: 19" wide, 8 $\frac{3}{4}$ " high, 13 $\frac{3}{8}$ " deep behind panel.
- Weight:** Net 26 lbs. shipping 29 lbs. (cabinet mount). Net 25 lbs. Shipping 34 lbs. (rack mount).
- Accessories Available:** 11000A Cable Assembly, \$4.50; 11001A Cable Assembly, \$5.50, 10501A Cable Assembly, \$3.50; 10503A Cable Assembly, \$6.50.
- Price:** Φ 211A, \$350.00 (cabinet); Φ 211AR, \$355.00 (rack mount).

Data subject to change without notice.

The Φ Model 211A Square Wave Generator is a versatile, wide range instrument particularly designed for testing video and audio amplifier performance,¹ or checking oscilloscope operation. It provides complete coverage of all frequencies from 1 cps to 1 MC, and has a rise time of 0.02 microsecond. There are two separate outputs—a 3.5 volt peak 75 ohm impedance circuit for television measurement, and a 27 volt peak 600 ohm output for high level work. The positive excursions of the output signals are clamped to chassis. Full amplitude variation is available on either output. The generator may be operated free-running or externally synchronized with either a positive going pulse or a sine wave signal of 5 volts peak minimum amplitude.

Uses

Model 211A is ideal for testing amplifiers and networks and modulating signal generators. It will measure time constants, check oscilloscope sweep circuits, and generate harmonics for frequency multiplication. It offers a simple means of controlling an electronic switch. The generator is also a convenient instrument for indicating phase shift, frequency response, transient effects or deflection polarity of oscilloscopes.

¹See Hewlett-Packard Application Note 17, "Square Wave and Pulse Testing."



212A PULSE GENERATOR

Basic Test Instrument for Radar, TV and Other Fast Circuits

Popular *hp* 212A Pulse Generator provides positive or negative pulses, and may be synchronized to other equipment through built-in delay and advance sync out circuits. It offers pulse lengths continuously variable from 0.07 to 10 microseconds, has a direct reading pulse length control, and provides pulses of 50 watts peak power. Pulses are of high quality, with very fast 0.02 microsecond rise and decay, "flat" top and minimum overshoot. The instrument delivers accurate pulses to the end of a long transmission line. If the line is correctly terminated, pulse shape is independent of line length, sync conditions, input voltage or output attenuator setting.

Double pulses can be obtained by connecting a stub line across the output of the generator.

In addition to radar, tv, and nuclear work, the generator is useful for testing response of rf amplifiers, filters, band pass circuits, oscilloscopes; and in checking peak measuring equipment, modulating rf carriers or pulse modulating uhf signal generators.

Specifications

Pulse: Length continuously variable 0.07 to 10 μ sec. Amplitude 50 v peak, positive or negative, into 50-ohm load (50 watt peak).

Amplitude Control: 50 db attenuator, variable in 10 db steps. Continuously variable amplitude control, 10 db range.

Pulse Shape: Rise and decay time each approximately 20 nsec. Crest variation less than $\pm 5\%$.

Jitter: Less than 10 nsec.

Internal Impedance: 50 ohms or less, either pulse polarity.

Repetition Rate: Internal sync, 50 to 5000 pps. External sync, approx. 2 to 5000 pps.

Sync In: ± 5 v peak minimum.

Sync Out: + 25 v or - 15 v into 2000 ohms load. Approx. 1 μ sec duration at half voltage. Rise time approx. 0.25 μ sec.

Pulse Position: Referenced to Sync Out pulse: Delay, 0 to 100 μ sec (to 2500 pps), 0 to 50 μ sec (to 5000 pps). Advance, 0 to 10 μ sec (to 5000 pps).

Power: 115 or 230 v $\pm 10\%$, 50 to 60 cps, 380 watts.

Dimensions: Cabinet: 20 $\frac{3}{4}$ " wide, 12 $\frac{3}{4}$ " high, 14-3/16" deep. Rack Mount: 19" wide, 10 $\frac{1}{2}$ " high, 13 $\frac{3}{8}$ " deep behind panel.

Weight: Net 56 lbs. Shipping 68 lbs. (cabinet). Net 50 lbs. Shipping 65 lbs. (rack mount).

Accessories Available: *hp* 10503A BNC Cable Assembly, \$6.50; *hp* 11500A Type N Cable Assembly, \$15.

Price: *hp* 212A, \$600 (cabinet); *hp* 212AR, \$585 (rack mount).

Data subject to change without notice.

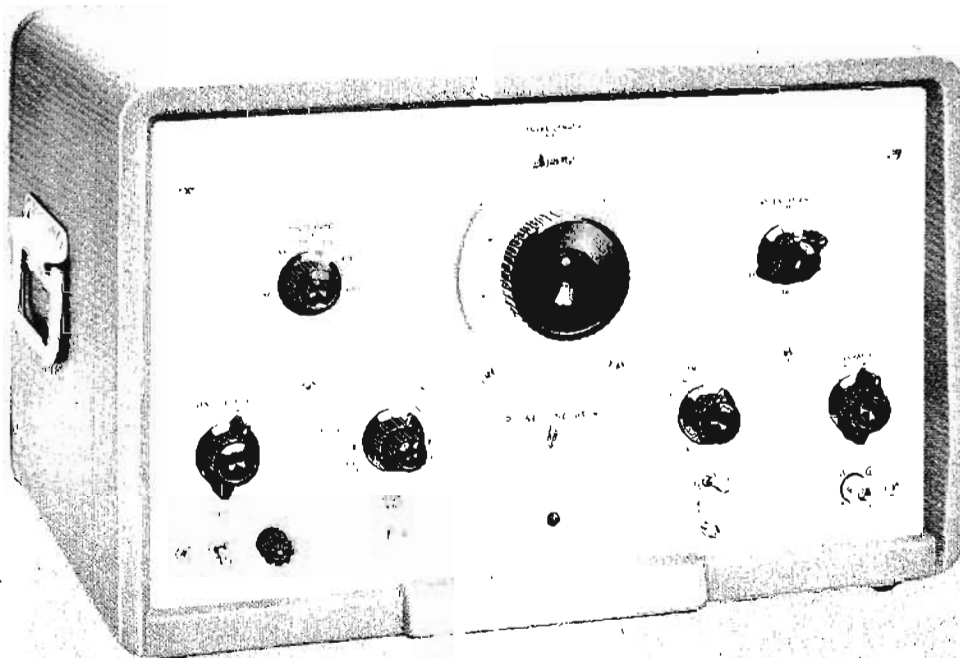

214A PULSE GENERATOR

Delivers 200 Watts Pulse Power

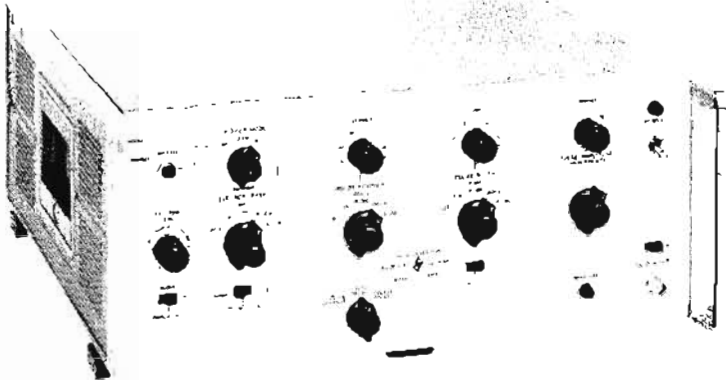

**NEW IN THIS
CATALOG**

Advantages:

- 200 watts peak power, positive or negative 100 volt pulses into 50 ohms
- Controlled pulse shape for accurate measurements
- 50-ohm matched source impedance eliminates errors from reflections
- Oscilloscope type trigger controls permit selection of slope and level
- Double pulse operation for resolution tests

Uses:

- Testing magnetic cores
- Checking switching times of high power semiconductors
- Testing high power amplifiers and modulators
- Radar, nuclear and tv tests

The *hp* Model 214A features 200 watts pulse power, controlled pulse shape, external trigger slope and level selection, and a 50-ohm source impedance for general purpose lab and production measurements.

200 watts (2 amps peak) pulse power, four times the power previously available commercially, is particularly suited for testing current-driven devices such as magnetic memory cores, as well as high power modulators. At output levels below 50 volts, the pulse generator has a matched source impedance of 50 ohms, eliminating error-producing reflections. Reflections from the circuit under test are absorbed in the 50-ohm source impedance; the output pulse is clean and free of error-inducing reflections even though the impedance of the circuit under test may be complex. At reduced output levels the duty cycle may be as high as 50%, permitting square wave testing.

The pulse characteristics are carefully controlled and pulse rate, width and delay jitter are kept to a minimum to insure accurate, dependable test results.

The 214A offers extremely wide range of trigger control for syncing on external signals. It will trigger on external signals as small as 1 volt peak (either polarity). In addition, slope and level may be selected so that triggering occurs at a given point on the trigger waveform. The 214A may be externally triggered from dc to 1 megacycle or internally from 10 cycles to 1 megacycle. Also provided is a trigger output signal for use in synchronizing external equipment. This trigger signal is continuously adjustable from 0 to 10,000 microseconds delay or advance with respect to the output pulse.

The pulse generator may be gated on to provide bursts of pulses. This feature is especially useful for computer logic measurements. Also, a double pulse feature is provided for pulse resolution tests of amplifiers and memory cores.

Fast rise, high power pulses with carefully controlled characteristics make this instrument unexcelled for general testing requirements.

Specifications

Output Pulse

- Source Impedance: 50 ohms on 50 v range and below 50 volts. Approximately 1500 ohms on 100 v range.
- Pulse Shape:
 - Rise and fall time: 50 v range and below: Less than 13 nsec; typically less than 10 nsec when vernier is out. 100 v range: typically 15 nsec.
- Pulse Amplitude: Greater than 100 volts into 50 ohms. Attenuator provides 9 ranges from 0.2 volt to 100 volts in a 1, 2, 5, 10 sequence. Vernier provides continuous adjustment between ranges and extends lower output pulse level to 80 mv.
- Polarity: Positive or negative.
- Leading and Trailing Edge Overshoot: Less than 5%.
- Pulse Top Variations: Less than 4%.
- Pulse Droop: Less than 5%.
- Prehoot: Less than 2%.
- Pulse Width:
 - Range: 0.05 microseconds to 10 milliseconds in 5 decade ranges and continuously adjustable vernier.
- Jitter: Less than 0.5% of pulse width plus 1 nsec.
- Duty Cycle: Maximum duty cycle on 100 volt and 50 volt range is 10%; 20 volt range 25%, 10 volt range and below, 50%.

Repetition Rate, Trigger and Timing

- Internal:
 - Repetition Rate: 10 cps to 1 mc continuously adjustable, 5 decade ranges plus vernier.
 - Jitter: Less than 0.5% of the period.
 - Manual: Pushbutton single pulse; maximum rate 2 pps.
- External:
 - Repetition Rate: dc to 1 mc (sine to square wave).
 - Sensitivity: Less than 1 volt peak.
 - Slope: Positive or negative.
 - Level: Trigger point may be selected over positive or negative 40 volt range.
- External Gating: + 8 volt signal will gate pulse generator on.
- Double Pulse:
 - Minimum Spacing: 1 μ sec between pulses.
 - Adjustable Range: 25% of upper limit of pulse width range used.
- Trigger Output Pulse:
 - Width: 0.05 μ sec nominal.
 - Amplitude: 10 volts into 1000 ohms.
 - Polarity: Positive or negative.
 - Advance or Delay: 0 to 10 msec in 5 decade ranges plus continuously adjustable vernier.
 - Jitter from Output Pulse: Less than 0.05% of advance or delay setting plus 1 nsec.

General

- Power: 115 or 230 v \pm 10%, 50 to 60 cps, 325 watts.
- Dimensions: 16 $\frac{3}{4}$ " wide, 7 $\frac{1}{4}$ " high, 18 $\frac{3}{8}$ " deep overall; hardware furnished for quick conversion to 7" x 19" rack mount, 16 $\frac{3}{8}$ " depth behind panel.
- Weight: Net 35 lbs. Shipping 48 lbs.
- Price: \$875.

hp 215A PULSE GENERATOR

NEW IN THIS
CATALOG

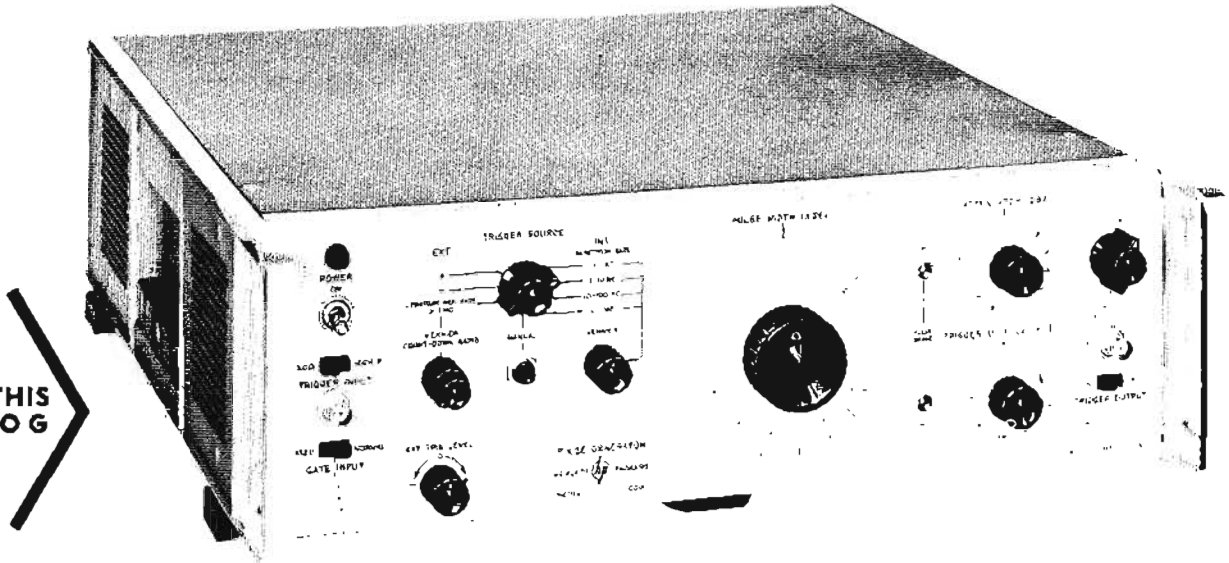

Advantages:

- True 50-ohm source impedance minimizes reflections
- DC coupled output eliminates duty cycle effects
- High quality pulse shape with low jitter for accurate measurements
- Output pulses with 1 nsec rise and fall times, either polarity
- Calibrated, continuously variable dials make pulse width and delay easy to set
- Convenient amplitude selection with calibrated attenuator

Uses:

- Determine step response of circuits
- Locate sources of reflections in transmission and delay lines or measure the electrical length of cables
- Measure switching, recovery and storage times of semiconductors and thin film memory units

The Model 215A Pulse Generator combines in one compact unit the many capabilities desired for fast pulse testing. One nanosecond rise and fall time pulses of either polarity with nearly an ideal pulse shape, combined with calibrated pulse width and delay controls, adjustable pulse amplitude, variable pulse rate to 1 mc and a true 50-ohm source impedance provide maximum measurement capabilities.

The true 50-ohm source impedance insures clean output pulses, regardless of the load impedance, since any reflection from the circuit under test will be absorbed by the 50-ohm generator impedance.

The pulse is generated in a solid state output circuit using specially manufactured semiconductors to insure high quality pulses and maximum reliability. The output pulse of the 215A is carefully controlled to approximate an ideal pulse shape and is specified in every respect for accurate, dependable measurements.

Versatile, reliable and easily operated, the hp 215A is

useful in production testing, as well as in laboratory and research applications with fast oscilloscopes such as the hp 185A,B. The fast rise and fall time and extremely low pulse jitter make the 215A particularly useful in measuring transition storage times of semiconductors, logic circuits and thin film memory units. The 215A may also be used to locate the position and determine the magnitude of reflections in transmission lines or the relative location of a faulty component in a lumped constant delay line or attenuator (refer to "Time Domain Reflectometry," page 45).

Specifications Output Pulse

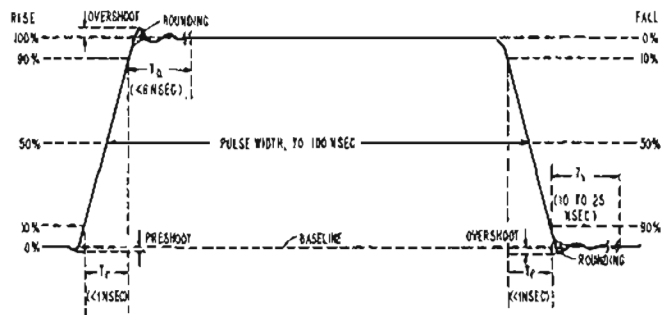

Source Impedance: 50 ohms; 3% maximum reflection when driven by a pulse with 1 nsec rise time from an external 50-ohm system.

Leading Edge Only:

Rise Time (T_r): < 1 nsec (10 to 90%).

Overshoot and Ringing: < 5% peak, less than 10% peak-to-peak of pulse amplitude.

Corner Rounding: Occurs no sooner than 95% of pulse amplitude.

Time to Achieve Flat Top (T_b): < 6 nsec.

Trailing Edge Only:

Fall Time (T_f): < 1 nsec (10 to 90%).

Overshoot: $< 5\%$.

Rounding: Occurs no sooner than 95% of fall.

Time to Settle within 2% of Baseline (T_s): 10 to 25 nsec, varies with width setting.

Baseline Shift: $< 0.1\%$ under all conditions.

Preshoot: $< 1\%$.

Perturbations on Flat Top: $< 2\%$ of pulse amplitude.

Peak Voltage: > 10 volts into 50 ohms. > 20 volts open circuit.

Polarity: Positive or negative.

Attenuator: 0 to 12 db in 1 db steps, absolute accuracy within ± 0.1 db.

Pulse Width (between 50% Points): Continuously adjustable to 100 nsec. Dial accuracy within $\pm 5\% \pm 3$ nsec, width jitter < 50 psec.

External Bias: Up to ± 100 ma (± 5 v dc) may be safely applied to the output. At 0 db attenuator setting, up to 10 ma (0.5 v dc) may be applied without significant change in pulse shape (5% droop), increasing to 40 ma at 12 db setting. In most cases, adjusting the front panel pulse-shape controls will restore original pulse shape.

Repetition Rate, Trigger and Timing Specifications

Repetition Rate Sources:

Internal Repetition Rate: < 100 cps to > 1 mc in 4 ranges, continuously variable between ranges. Period jitter $< 3 \times 10^{-3}$ of one period.

Manual: Pushbutton single pulse.

External Triggering: AC coupled. Sine waves from 10 cps to 1 mc; pulses from 0 to 1 mc; either positive or negative slope.

Trigger Level: External trigger level continuously variable from approximately $+ 8$ to $- 8$ volts.

Sensitivity: 1 volt peak-to-peak minimum. External pulses must be at least 30 nsec wide. Maximum input 50 v peak, $\frac{1}{2}$ watt maximum average power.

Input Impedance: Approximately 50 ohms or High Z available by front panel switch. High Z is approximately 100K for negative slope setting, approximately 5K for positive slope setting.

Countdown: Counts down from frequencies to 100 mc, 2 v rms amplitude; resulting pulse repetition rate is always less than 1.3 mc. Jitter is less than 10% of one period of the triggering signal.

External Trigger Delay: Approximately 300 nsec between leading edge of trigger pulse (2 volt step, 2 nsec rise time into 50 ohms) and leading edge of output pulse; < 50 psec jitter.

External Gating: Gates on with a $+ 1$ volt pulse. Maximum input 50 v peak, 20 v rms.

Trigger Output Pulse:

Width: 50 nsec $\pm 20\%$ into 50 ohms.

Amplitude: > 1 volt peak into 50 ohms.

Rise Time: < 5 nsec.

Polarity: Positive or negative.

Triggering Timing: Adjustable from 10 nsec delay to 140 nsec advance with respect to leading edge of output pulse. Dial accuracy within $\pm 10\% \pm 5$ nsec. Jitter < 50 picoseconds.

General

Power Consumption: 115 or 230 volts $\pm 10\%$, 50 to 60 cps, 60 watts.

Dimensions: $5\frac{1}{2}$ " high, $16\frac{3}{4}$ " wide, $18\frac{3}{8}$ " deep. Hardware furnished for quick conversion to $5\frac{1}{4}$ " x 19" rack mount, $16\frac{3}{8}$ " deep behind panel.

Weight: Net 33 lbs. Shipping 49 lbs.

Accessories Furnished: *hp* 10120A Cable, 3 feet, BNC to BNC, 50 ohms $\pm \frac{1}{2}$ ohm.

Accessories Available: *hp* 10122A Cable, 3 feet, BNC to Type N, 50 ohms $\pm \frac{1}{2}$ ohm, \$10. *hp* 908A, 50 Ohm Coaxial Termination, \$35. *hp* 10240A Coaxial Blocking Capacitor to eliminate external dc from the 215A output circuitry, price on request.

Price: \$1875.

213B Pulse Generator

NEW IN THIS CATALOG

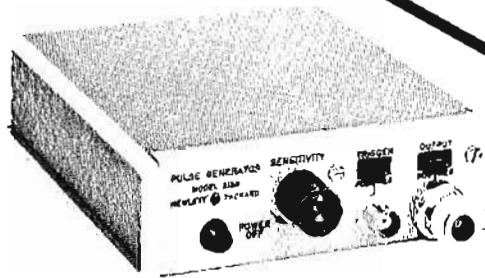

The *hp* 213B Pulse Generator provides 0.1 nsec rise time pulses at repetition rates to 100 kc for testing 185A,B oscilloscopes or other fast circuits. The pulse has minimum overshoot and is flat for 100 nsec after the very fast rise. Since the rise time of the 213B is much faster than that of most circuits, step response of these circuits may be measured directly without considering the rise time of the 213B. External trigger capabilities from 0 to 100 kc and a free-run rate above 100 kc give more versatility to this fast-pulse source.

The fast rise, low overshoot and 50-ohm source impedance of this compact pulse generator provide matched system capabilities for all fast pulse work. With the *hp* 185A,B Sampling Oscilloscopes this pulse generator may be used to determine cable impedances, locate and measure connector or cable discontinuities and evaluate cable terminations.

Specifications

Output:

Rise Time: Less than 0.1 nsec.

Top Droop: Less than 2% in first 100 nsec following the rise.

Width: Approximately 2 μ sec.

Amplitude: Greater than 175 mv into 50 ohms. 350 mv open circuit, either polarity.

Source Impedance: 50 ohms.

Jitter: Less than 20 psec when triggered with the 185A or 185B sync pulse.

Repetition Rate: Free runs at a rate greater than 100 kc, or may be triggered.

Trigger Input:

Amplitude: 0.5 v peak, either polarity.

Rise Time: 20 nsec or faster.

Width: At least 2 nsec.

Maximum Current: 200 ma peak.

Impedance: 200 ohms for signals less than 0.75 volt peak. Limiting lowers impedance to larger signals.

Repetition Rate: 0 to 100 kc.

General:

Power: 115 or 230 volts. $\pm 10\%$, 50 to 1000 cps, approximately 1 watt.

Dimensions: $1\frac{1}{2}$ " high, $5\frac{1}{8}$ " wide, 5" deep.

Weight: Net 2 lbs. Shipping 3 lbs.

Price: \$215.

Data subject to change without notice.

hp 218AR DIGITAL DELAY GENERATOR

± 1 Count Ambiguity Eliminated in Time Interval, Pulse Generation

The hp 218AR Digital Delay Generator is designed to generate precise time intervals and single, double or superimposed pulses. It is useful as a general purpose laboratory pulse generator and because of its versatile plug-in pulse generators, it can often take the place of several special purpose instruments.

The 218AR consists of (1) a pulsed crystal oscillator which is started in known phase by the initial trigger (start) pulse, eliminating the ± 1 count error; (2) a dual-preset digital counter which counts the crystal or externally applied frequency, and operates (3) two preset gates which pass the selected pulses.

Plug-ins Increase Versatility

Plug-ins include the 219A Dual Trigger Unit to supply trigger pulses for controlling auxiliary equipment, \$125; the 219B Dual Pulse Unit to deliver fast rise time, high power pulses that are digitally delayed, \$490; and the 219C Digital Pulse Duration Unit which produces a high power output pulse whose delay and duration may be digitally controlled, \$375. Output pulses of the 219A are identical to the sync output of the 218AR. The 219B pulses are individually adjustable, 0 to ± 50 v peak open circuit. Pulses from the 219C are 90 v peak (or more), open circuit, from a 500-ohm source or adjustable from 0 to 15 v peak from a 90-ohm source. The positive excursion of the pulses is clamped to ground, and both positive - and negative - going pulses are available simultaneously.

Specifications

218AR

(Plug-in necessary to operate)

Time Interval Range: (T_0 to T_1 and T_0 to T_2) 1 to 10,000 μ sec.

Accuracy $\pm 0.1 \mu$ sec $\pm 0.001\%$ of time interval selected.

Digital Adjustment: 1 to 9999 μ sec in 1 μ sec steps.

Interpolation: Continuously adjustable. Adds 0 to 1 μ sec to digital setting.

Input Trigger: Internal: 10 cps to 10 kc, 3 decade ranges. External: Sine wave, 5 to 40 v rms, 10 to 100 cps; 2 to 40 v rms, 100 cps to 10 kc. Pulse, 0 to 10 kc, positive or negative, 2 to 40 v peak.

For trigger rise time of 0.05 μ sec or less, delay between external trigger and T_0 is less than 0.5 μ sec. Manual: Pushbutton operation.

Jitter: 0.02 μ sec or less.

Recovery Time: 70 μ sec or 10% of selected interval, whichever is greater.

Sync Output: Positive pulse, 50 to 70 v peak, open circuit, 0.1 μ sec rise time. Width more than 1.5 μ sec. Available at T_0 , T_1 or T_2 .

1 MC Output: 1 mc positive pulses (1 v from 500-ohm source) provide timing comb synchronized to start pulses. Available at panel connector for duration of longer delay when counting internal 1 mc oscillator.

External Counting: External sine waves, 2 v rms minimum, 100 cps to 1 mc; 5 v rms minimum, 10 to 100 cps, and positive pulses, periodic or random, 2 v peak, 0 to 1 mc can be counted instead of internal standard. Time interval range becomes 1 to 9999 periods in 1-period steps and accuracy is $\pm 0.1 \mu$ sec ± 1 period.

Power: 115 or 230 v $\pm 10\%$, 50 to 60 cps, 555 watts.

Dimensions: 14" high, 19" wide, 21 $\frac{3}{4}$ " deep behind panel.

Weight: Net, 75 lbs. Shipping, 103 lbs.

Price: \$2,000.

Data subject to change without notice.

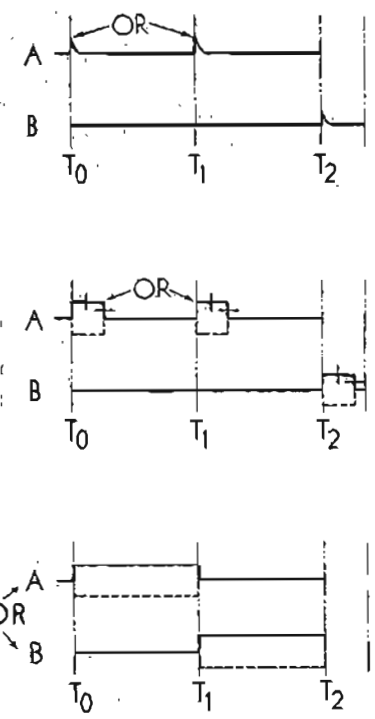
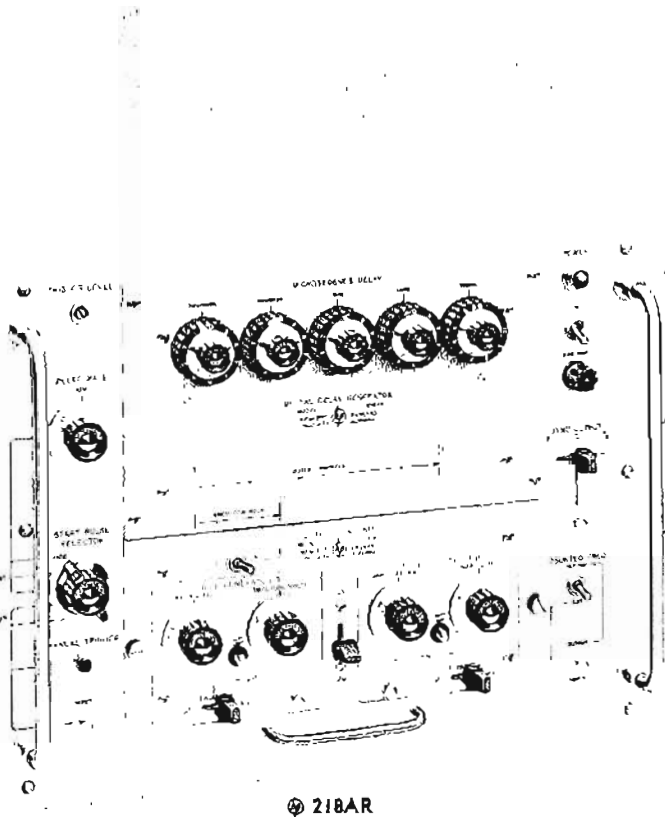

AUDIO-VIDEO Instrumentation

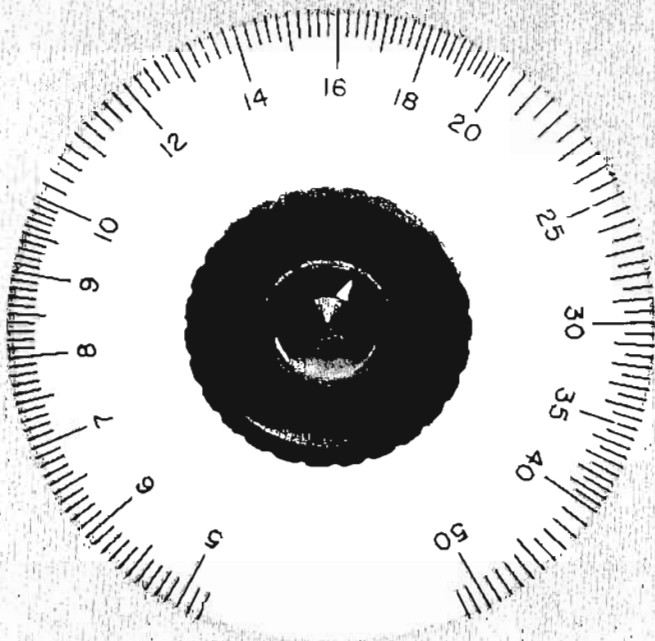

Oscillators

Audio Signal Generators

Attenuators

Wave and Distortion Analyzers

Voltmeters, Ohmmeters, Ammeters

Voltmeter Accessories

Function Generators

Amplifiers

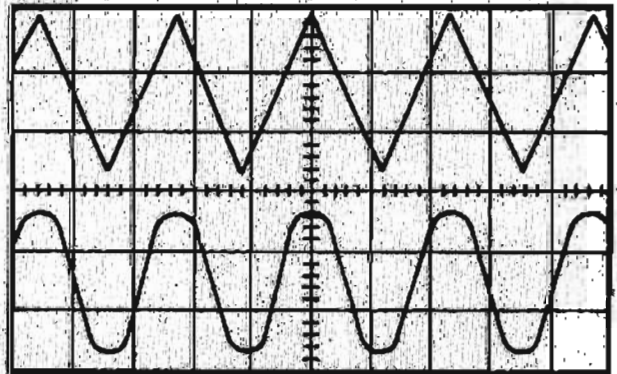

OSCILLATORS AND AUDIO SIGNAL GENERATORS

Oscillators generate sine wave signals of known frequency and amplitude for test and performance measurements on electronic circuits. These tests include gain, frequency response, attenuation, impedance and distortion. Signal generators fundamentally are oscillators too, but they are distinguished from oscillators by having wide range precision output attenuators and output meters for accurately measuring the voltage supplied to the load.

General purpose oscillators generate a broad range of frequencies at a variety of power levels for many different load impedances. The *hp* Model 200CD, for instance, covers a frequency range from 5 cps to 600 kc for a variety of test purposes. Other oscillators are designed for specific purposes, such as the *hp* Model 201C which is intended for audio frequency tests in the 20 cps to 20 kc frequency range, and the 200T Telemetry Oscillator which has a frequency coverage arranged so that no IRIG telemetry channel is cut by band switching.

Basic Oscillator Requirements

In selecting a test oscillator or signal generator, the user will be most interested in its frequency coverage. The questions to be answered here is: will the instrument supply both the lowest and highest frequencies of interest in anticipated tests? As shown on the chart, Hewlett-Packard manufactures a broad range of oscillators and audio frequency generators covering the frequency spectrum from 0.008 cps to 10 mc.

The user's next concern will be with the available output power or voltage. Some tests, such as those performed on long telephone lines, require definite amounts of power, while others merely

require sufficient voltage output. All *hp* oscillators are capable of several volts output into a high impedance load and several can supply watts of power into lower impedance loads.

Available output power is also related to the oscillator's output impedance. Most Hewlett-Packard oscillators have low internal impedances, which means that they are capable of supplying power into a wide variety of loads. In most cases, transformer coupling is used for a low-impedance output, some instruments having transformer taps for supplying the variety of impedances encountered in normal test work. Since many audio range oscillators are used with 600-ohm systems, many of these include a 600-ohm variable T-pad on the output side of the transformer. Some low power oscillators, intended for tests requiring extremely low distortion and exceptionally flat frequency response, have RC output coupling.

Besides frequency range and power output, which broadly define an oscillator's capabilities, the user will be interested in the oscillator's stability, its dial resolution, and the amount of distortion, hum and noise in the output signal.

Dial Resolution

In the ideal case, the user should be able to set the tuning dial of his oscillator to a particular frequency with assurance that the oscillator will deliver that frequency at all times. Any properly calibrated Hewlett-Packard oscillator has an output frequency which deviates from the dial indication by no more than 2%. Ordinarily, this is sufficient, since even with the large dials used on Hewlett-Packard oscillators, it is not possible to read the dial to a precision better than 2%.

Most Hewlett-Packard oscillators have 6-inch dials calibrated over at least 300 degrees, which means that each range of the instrument has more than 15 inches of calibration marks. One instrument, the 200J Interpolation Oscillator, has band switching on a 3.3-to-1 rather than a 10-to-1 basis to spread the tuning scale 3 times farther for more precise settings.

The accuracy with which the frequency tracks the tuning dial also enters into the overall accuracy figure. For maximum accuracy, the *hp* Model 200T Telemetry Oscillator provides front panel screwdriver controls for calibrating each range while the output frequency is being monitored with an electronic counter.

Frequency Stability

The frequency stability of the oscillator determines the ability of the instrument to maintain a selected frequency over a period of time. Component aging, power supply variations and temperature changes all affect stability. The *hp*-designed RC oscillator circuits, to be described later, assure stability by having large amounts of negative feedback. Carefully chosen components operated conservatively, such as stable carbon-deposited resistors in the frequency-determining networks, contribute to long-term stability. Oscillator stability is included in the overall 2% accuracy figure.

Amplitude Stability

Amplitude stability is important in certain oscillator applications, such as the driving source in bridge measurements or in magnetic amplifier circuits. Amplitude stability is inherent in the Hewlett-Packard RC oscillator circuit, again because of the large negative feedback factor and the amplitude stabilizing technique.

The "frequency response" or amplitude variation as the frequency is changed is of more interest, especially when the oscillator is used for response measurements throughout a wide range of frequencies. Frequency response of Hewlett-Packard oscillators varies less than 1 db throughout the mid-frequency range, though this may increase slightly at the extreme ends of the oscillator's range.

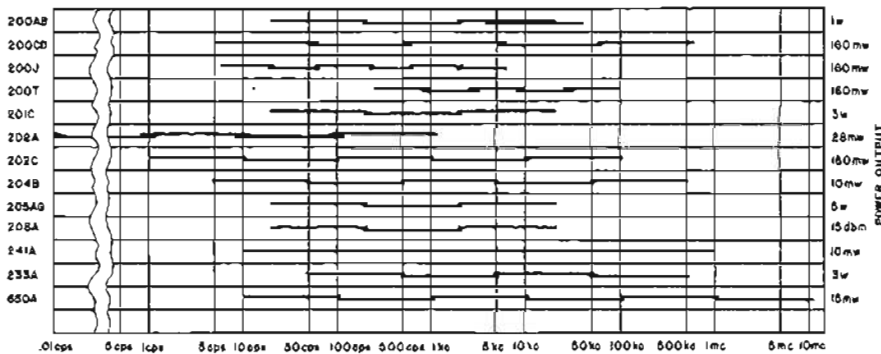

Table 1. Frequency range and power output of Hewlett-Packard Oscillators. Line segments show span of each range.

Distortion

Distortion in the oscillator's output signal is an inverse measure of the purity of the oscillator's waveform. Distortion is undesirable, in that a harmonic of the test signal may feed through the circuits under test, generating a false indication at the output. Besides, if the oscillator is used for distortion measurements, the amount of distortion that it contributes to the measurements should be far less than that contributed by the circuits under test.

The Hewlett-Packard Wien bridge RC oscillator is inherently a low distortion sine wave generator; all Hewlett-Packard Wien bridge oscillators have less than 1% distortion, typically 1/4%. Oscillator-amplifier operating levels are set so that the inevitable second harmonic introduced by small non-linearities in the transfer characteristic of one stage are cancelled by the following stage (second harmonic distortion of a sine wave in an amplifier usually results in flattening of one peak and stretching of the other). Where even 1/4% distortion may be too large, a selective amplifier following the oscillator will reduce this to less than 0.1%. A tuned, selective amplifier is used in the 206A Low Distortion Audio Signal Generator for this purpose.

Hum and Noise

Hum and noise are introduced at a variety of points in oscillator circuits but when the circuit operates at a relatively high level, generally 20 to 25 volts in Hewlett-Packard RC oscillators, the amount of hum and noise introduced into the oscillator circuits is usually negligible. However, hum and noise, introduced by a power amplifier following the amplitude control, remains constant as the output signal amplitude is diminished. Hence, even though the hum and noise power is quite small compared to rated output, these spurious signals may become a significant portion of low-level output signals. To overcome such a limitation, many Hewlett-Packard oscillators have their amplitude control on the output side of the power amplifier so that hum and noise are reduced proportionately with the signal when low-level signals are desired for test purposes.

Theory of Operation

The Hewlett-Packard-pioneered Wien bridge RC oscillator has become the standard oscillator circuit for variable frequency test signals below 200 kc. These oscillators are far less cumbersome than the LC types and far more stable than the beat frequency types formerly used for the below-100 range.

The basic oscillator circuit, shown in Fig. 1, is a 2-stage amplifier with both negative and positive feedback loops. Positive feedback for sustaining oscillations is applied through the frequency selective network, $R_1C_1 - R_2C_2$, of the

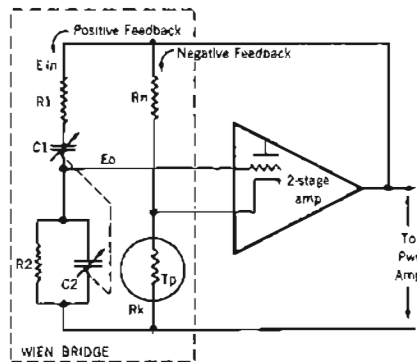

Figure 1. Basic hp Wien-bridge RC oscillator circuit.

Wien bridge. The amplitude and phase shift responses of this network, with respect to its driving voltage, are shown in Fig. 2. These show that the amplitude response is maximum at the same

frequency at which the phase shift through the network is zero. Oscillations are therefore sustained at this frequency. The resonant frequency, f_0 , is expressed by the equation

$$f_0 = \frac{1}{2\pi RC}, \text{ when } R_1 = R_2 \text{ and } C_1 = C_2$$

Unlike LC circuits, where the frequency varies as the square root of C , the frequency of the Wien bridge oscillator varies inversely as C . Thus, frequency variation greater than 10-to-1 is possible with a single sweep of an air-dielectric tuning capacitor. Range switching usually is accomplished by switching the resistors.

The negative feedback loop involves the other pair of bridge arms, R_n and R_k . R_k is a temperature-sensitive resistor with a positive temperature coefficient, usually an incandescent lamp operated at a temperature level lower than its illumination level. This lamp, being sensitive to the amplitude of the driving signals, adjusts the voltage division ratio of this branch accordingly. Thus, as the amplitude of oscillations increases, the resistance of R_k also increases, which in turn increases the amount of negative feedback, reducing the gain of the amplifier and restoring the amplitude to normal.

The amplitude of oscillations in any oscillator increases, because of the positive feedback, until some form of limiting occurs. In crystal and LC oscillators, amplifier saturation usually causes limiting so that any further increase in

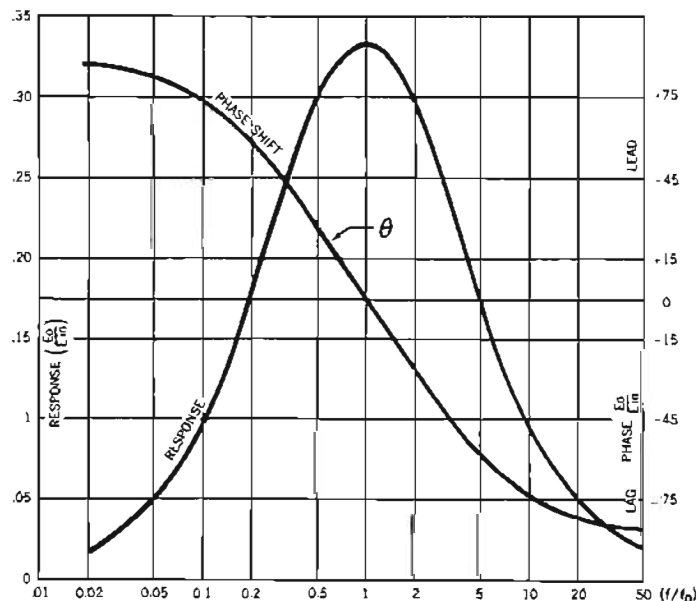

Figure 2. Characteristics of frequency determining network.

the oscillator-amplifier input results in no further increase in the output signal. Amplifier waveforms in these circuits are highly distorted and the output signal is usually taken from the resonant circuit to minimize output distortion. The *hp* Wien bridge RC oscillator, however, depends on the temperature-sensitive resistor for amplitude control. This means that the amplifier may be operated entirely within the linear portion of its transfer characteristic, resulting in purer sine wave output.

A different type of amplitude stabilization is used in the transistorized 204B Oscillator, because the current drawn by a lamp would be incompatible with long-term battery operation. This instrument uses a voltage comparison system which continuously compares the output voltage to a reference fixed by a zener diode and adjusts the amount of negative feedback accordingly.

The Wien bridge RC oscillator is capable of stable oscillations with low distortion output. With the addition of a high quality power amplifier to isolate the oscillator from the load, this circuit is capable of providing useful test signals for a broad variety of purposes. The low cost *hp* Model 200AB Oscillator uses just such an arrangement.

Pushbutton Tuning

Pushbutton oscillator tuning is possible with a modified Wien bridge, as shown in Fig. 3. Here, the resis-

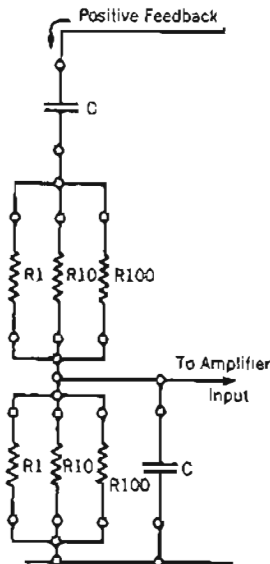

Figure 3. Frequency selective network for pushbutton oscillator.

tive branches of the frequency-selective network are made up of parallel combinations of resistors. It is easily shown through algebraic reduction that substitution of the parallel combination of R_1 , R_{10} and R_{100} for R in the basic frequency determining equation, $f = \frac{1}{2\pi RC}$, results in:

$$f = \frac{1}{2\pi R_1 C} + \frac{1}{2\pi R_{10} C} + \frac{1}{2\pi R_{100} C}$$

or, $f_{total} = f_{units} + f_{tens} + f_{hundreds}$

Thus, frequency increments chosen by any pair of resistors are not affected by settings of the other two pairs.

The 241A Pushbutton Oscillator, shown in Fig. 4., has three pushbutton

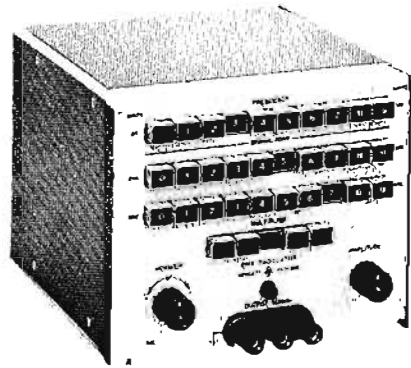

Figure 4. *hp* 241 Pushbutton Oscillator.

decade switch selectors for changing the resistors in the frequency selective network. Each decade selects resistive values for one pair of resistors in the frequency-determining network.

Ranges are switched by changing capacitors with a five-position pushbutton switch. Total frequency range of the 241A Oscillator is from 10 cps to 1 mc in 4500 discrete steps. An overlapping vernier control permits setting to intermediate frequencies.

Pushbutton tuning enables the frequency to be changed by precise increments. Frequency selection to three-digit resolution with 1% accuracy and resetability to within 0.02% are possible.

Push-Pull RC Oscillator

A more refined circuit, the push-pull Wien bridge RC oscillator, is shown in Fig. 5. Although increasing the cost and complexity of the instrument, this circuit provides several refinements over the basic single-ended oscillator circuit. For one, the circuit is operating in a push-pull mode, which means that push-pull output may be obtained di-

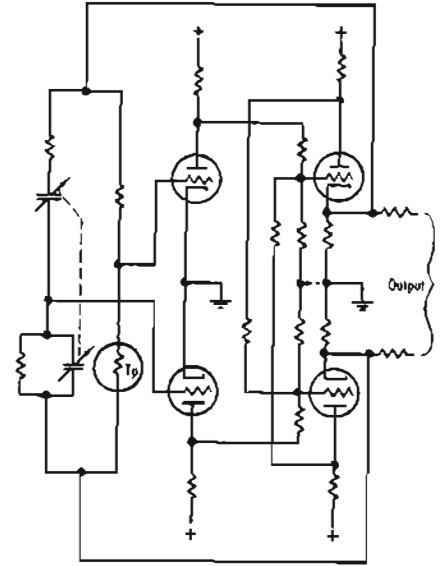

Figure 5. Push-pull RC oscillator.

rectly from the oscillator-cathode followers without use of a transformer.

The circuit has zero output impedance because of positive feedback added from each output tube plate to the control and screen grids of the opposite output tube. Zero output impedance means that the circuit is insensitive to load changes. Positive feedback effectively increases the amplifier gain, A , to infinity. From the equation, $Z'_o = Z_o / (1 + A\beta)$, where Z'_o is the output impedance without feedback and β is the stabilizing negative feedback factor, it can be seen that the output impedance Z'_o becomes zero if A is infinite. Series resistors are inserted in the output leads to present a 600-ohm impedance to the load and also to prevent short circuiting of the power tubes' cathodes.

In the push-pull circuit, no dc passes through the lamp circuit, the lamp current being pure ac. This means that lamp heating occurs at twice the oscillating frequency, enabling the circuit to operate down to $1/2$ of the limiting lowest frequency of the single-ended oscillator. In addition, the capacitor tuning rotors are near ground potential, reducing leakage effects in these capacitors and permitting larger resistors to be used in the RC circuits for low frequency operation. This improved circuit is used in the 200CD Wide Range Oscillator, the 202C Low Frequency Oscillator, and the 200J Low Distortion Interpolation Oscillator.

Low Distortion Signal Generator

Distortion can be reduced further by a tuned filter following the oscillator circuit. The 206A Audio Signal Generator, for instance, has a selective amplifier between the oscillator and power output circuit. This amplifier has a negative feedback loop which includes an RC rejection filter. The capacitors of the rejection filter are ganged on the same shaft with the oscillator's capacitors, so that the rejection filter and oscillator are always tuned to the same frequency.

The oscillator's fundamental frequency does not pass through the amplifier's negative feedback loop because of the rejection filter; therefore, amplifier gain at this one frequency is not reduced by negative feedback. All other frequencies do pass through the negative feedback loop and as a result amplifier gain is reduced at all harmonic frequencies. A 10 db improvement in the ratio of the fundamental to its harmonics is obtained with this arrangement.

High Frequency Oscillator

The high frequency limits of the RC oscillator are imposed by the amplitude and phase characteristics of the oscillator-amplifier. Phase shift in the amplifier calls for a compensating shift in the RC network, if oscillations are to be sustained. This means that the frequency of oscillations will not be the same as f_0 of the RC network; thus, the calibration of the tuning dial would be off at high frequencies. It is interesting to note that an amplifier phase shift of just a fraction of a degree causes 1% error in calibration, whereas conventional amplifier performance is specified by the 3 db points, where there is a 45 degree phase shift.

Because of the difficulty of designing amplifiers without phase shift at high frequencies, a different RC circuit is used for higher frequencies. The *hp* wide-range 650A Test Oscillator uses a 3-stage phase shift oscillator on its two highest ranges (100 kc to 10 mc).

The basic circuit of this oscillator, which "swamps out" tube and wiring capacitances, is shown in Fig. 6. Each RC network introduces a 60-degree phase shift into the signal. With 3 networks, each with 60 degrees' phase shift at a particular frequency, and 3 amplifier stages, each introducing 180-degree phase shift, total phase shift around the loop is 720 degrees. This means that

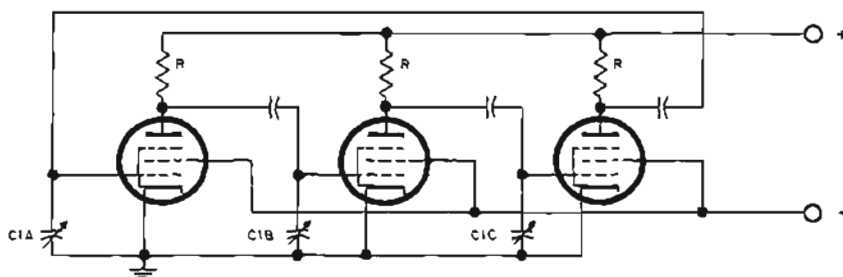

Figure 6. Phase-shift oscillator.

the feedback loop has in-phase positive feedback at that particular frequency. The 650A uses a Wien bridge RC oscillator on its 4 lowest ranges, and the phase shift oscillator above 100 kc.

Low Frequency Oscillator

Low frequency operation of an RC oscillator circuit also may be hampered by amplifier phase shifts. These may be compensated for, however, in which case the low frequency limit is set by the thermal characteristics of the temperature sensitive resistance. At very low frequencies, the incandescent lamp has time to heat and cool during each cycle. This change of resistance during each cycle introduces serious amounts of distortion in the output.

For very low frequencies, then, an entirely different approach is used in the 202A Function Generator (this instrument is called a function generator because it is often used in analog computers and servo systems). The circuit of this instrument, outlined in Fig. 7, uses a dc coupled flip-flop. The output of the flip-flop is passed to a Miller integrator whose output is coupled back to trigger points in the flip-flop.

Circuit operation is as follows: The integrator converts the flip-flops step voltage to a ramp. When the ramp reaches a preset amplitude level, it triggers the flip-flop into its other stable state. (Transformer coupling between cathode and grid induces a regenerative

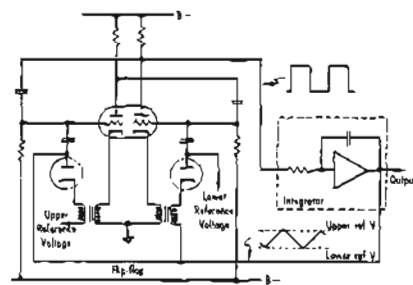

Figure 7. Low-frequency RC oscillator.

action which speeds triggering action.) The ramp then changes slope and continues until the other trigger level is reached. Adjustment of the RC time constant of the integrator controls the ramp slope, which in turn controls the multivibrator frequency.

This circuit produces low frequency square and triangular waves. The triangular wave is synthesized into a sine wave by a non-linear diode-resistance network. The synthesizing circuit,

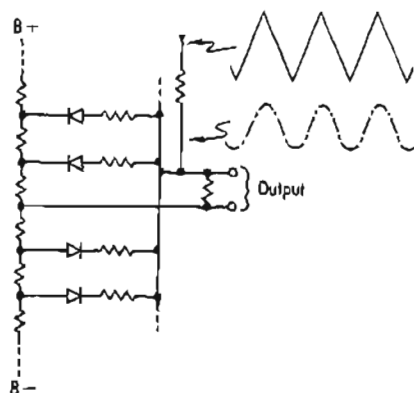

Figure 8. Non-linear shaping network.

sketched in Fig. 8, shows how the slope of the triangular wave is altered as its amplitude changes, resulting in a remarkably pure sine wave. In practice, twelve diodes are used for the shaping.

The entire oscillator circuitry is floating, so that ground may be established at any desired voltage level. A special feature of this oscillator is that waveform amplitude is controlled by the reference voltages, rather than by a long time-constant AGC circuit. As a result, there are no transients when switching between ranges or tuning to other frequencies.

The RC oscillator circuits described here are used in Hewlett-Packard's diverse line of oscillators and audio signal generators. These span a frequency range of 48.8 cycles per hour (0.008 cps) to 10 mc, covering the subsonic, audio, ultrasonic, video and low rf ranges.

200 SERIES AUDIO OSCILLATORS

Exceptional Value, Highest Quality

Advantages:

- No zero setting, high stability
- Constant output
- Wide frequency range
- Logarithmic scale
- Low distortion
- Compact, light weight

Use For:



- Amplifier testing
- Transmitter audio response
- Voltage source for bridge measurements
- Modulating signal generators
- Ultrasonic voltage source
- Driving mechanical systems
- Synchronizing pulse generators
- Loudspeaker resonance tests

Hewlett-Packard RC oscillators have long been basic tools for making electrical and electronic measurements of precise accuracy. These world-famous test instruments give you the most compact, dependable, accurate and easy-to-use commercial oscillators available.

The  200 series oscillators have high stability and accurate, easily resettable tuning circuits. Low impedance operating levels together with superior insulation guarantee peak performance throughout years of trouble-free service. The instruments have wide frequency range and long dial lengths and feature an improved vernier frequency control. Operation is simplified—just three controls are required. Instruments are compact, light in weight and enclosed in a convenient, aluminum case with carrying handle. They occupy minimum bench space and are easily portable. Rack mounting is available on order.



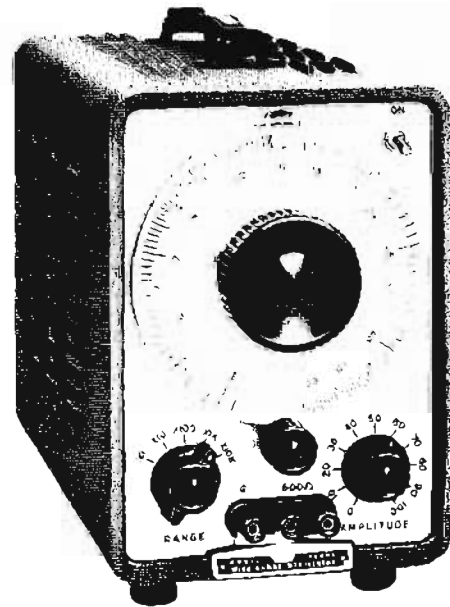

 200AB Audio Oscillator
Low Cost, 20 CPS to 40 KC

This basic oscillator is a compact, convenient source of precision audio test voltages at extremely low price. Frequency coverage is 20 cps to 40 KC in four overlapping bands. The 63" effective scale length and 72 dial divisions insure accurate direct frequency setting. Output is balanced for dependable driving of transmission systems. The 200AB is ideal for amplifier testing, as a bridge voltage source, for testing transmitter modulator response, modulating signal generators, syncing pulse generators and making loudspeaker resonance tests.  200AB, \$165.00 (cabinet);  200ABR, \$170.00 (rack mount).



 200CD Wide Range Oscillator
Multi-Purpose, 5 CPS to 600 KC

One of the most popular of all  oscillators, Model 200CD covers the range 5 cps to 600 KC and is particularly useful for testing servo and vibration systems, medical and geophysical equipment, audio amplifiers, sonar and ultrasonic apparatus, carrier telephone systems, video frequency circuits, etc. Waveform purity is maintained with extremely low loads. Frequency is covered in 5 decade ranges, and accuracy is $\pm 2\%$ including warmup, aging, tube changes, etc. Frequency response is ± 1 db full range.  200CD, \$195.00 (cabinet);  200CDR, \$200.00 (rack mount).

Specifications

Model	Frequency Range	Calibration Accuracy	Output to 600 ohms	Output Impedance	Maximum Distortion	Max. Hum & Noise †	Input Power	Weight—Lbs.		Size (Inches)			Price
								Net	Ship	W	H	D	
200AB	20 cps to 40 KC (4 bands)	± 2%	1 watt (24.5 v)	75 ohms	1% 20 cps to 20 KC 2% 20 KC to 40 KC	0.05%	70 watts	15	20	7½ x 11½ x 12			\$165
200CD	5 cps to 600 KC (5 bands)	± 2%	160 mw (10 volts)	600 ohms	0.5% below 500 KC 1% 500 KC and above	0.1%	75 watts	22	27	7¾ x 11½ x 14¾			\$195
201C	20 cps to 20 KC (3 bands)	± 1% †	3 watts (42.5 v)	600 ohms*	0.5% †	0.03%	75 watts	16	23	7½ x 11½ x 12½			\$250
202C	1 cps to 100 KC (5 bands)	± 2%	160 mw (10 volts)	600 ohms	0.5% ‡	0.1%	75 watts	27	34	7½ x 11½ x 14¼			\$300

*Internal impedance approximately 600 ohms with output attenuator at 10 db or more. Approximately 75 ohms below 5,000 cps with attenuator at zero. † Internal, non-operating controls permit precise calibration of each band. ‡ 0.5%, 50 cps to 20 KC at 1 watt output. 1.0% over full range at 3 watts output. § Above 5 cps. † Measured with respect to full rated output.

Frequency Response: Flat ± 1 db over instrument range. Reference level at 1 KC.

Size and Weight: Maximum overall size and weights are given for cabinet models. 19" rack models also available.

Power Source: 115 or 230 volts ± 10% at 50 to 1,000 cps.
Accessories Available: 11000A Cable Assembly, \$4.50; 11001A Cable Assembly, \$5.50; 11004A, 11005A Line Matching Transformers, see page 111.

Data subject to change without notice.

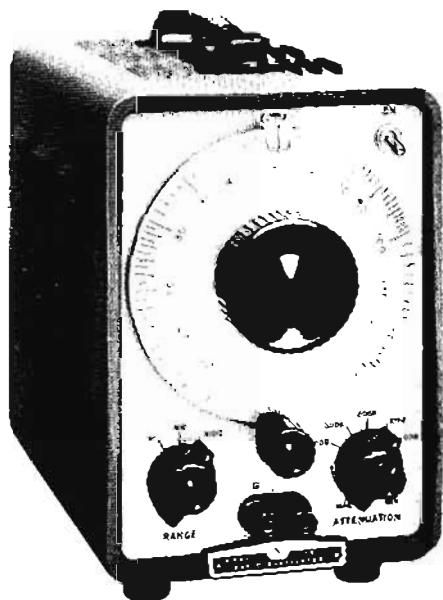

Ⓢ 201C Audio Oscillator
High Power, 20 CPS to 20 KC

Particularly designed for amplifier testing, transmission line measurements, loud speaker testing, frequency comparison and other high fidelity tests, this audio oscillator meets every requirement for speed, simplicity and pure waveform. The frequency range 20 cps to 20 KC is covered in 3 bands; response is ± 1 db full range. Output is 3 watts or 42.5 volts into 600 ohms; an attenuator adjusts output 0 to 40 db in 10 db steps and provides either low impedance or constant 600 ohm impedance. Distortion at 1 watt output and above 50 cps is less than 0.5%. Ⓢ 201C, \$250.00 (cabinet); Ⓢ 201CR, \$255.00 (rack mount).

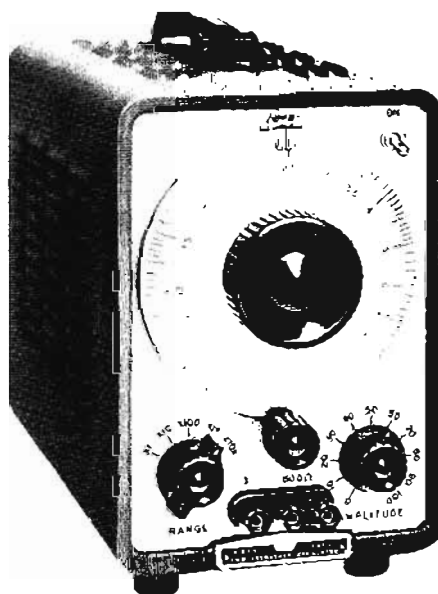

Ⓢ 202C Low Frequency Oscillator
Excellent Waveform, 1 CPS to 100 KC

Model 202C brings to the low frequency spectrum the accuracy and stability you associate with audio measurements. It provides excellent waveform throughout its broad frequency range of 1 cps to 100 KC, and has unique usefulness in industrial, field or laboratory work. Model 202C is extremely convenient for vibration, stability, electro-cardiograph, electro-encephalograph and other measurements in the subsonic, audio and ultrasonic fields. Distortion is less than 0.5%, hum voltage is less than 0.1%, and recovery time is extremely short—5 seconds at 1 cps. Ⓢ 202C, \$300.00 (cabinet); Ⓢ 202CR, \$305.00 (rack mount).

204B PORTABLE OSCILLATOR

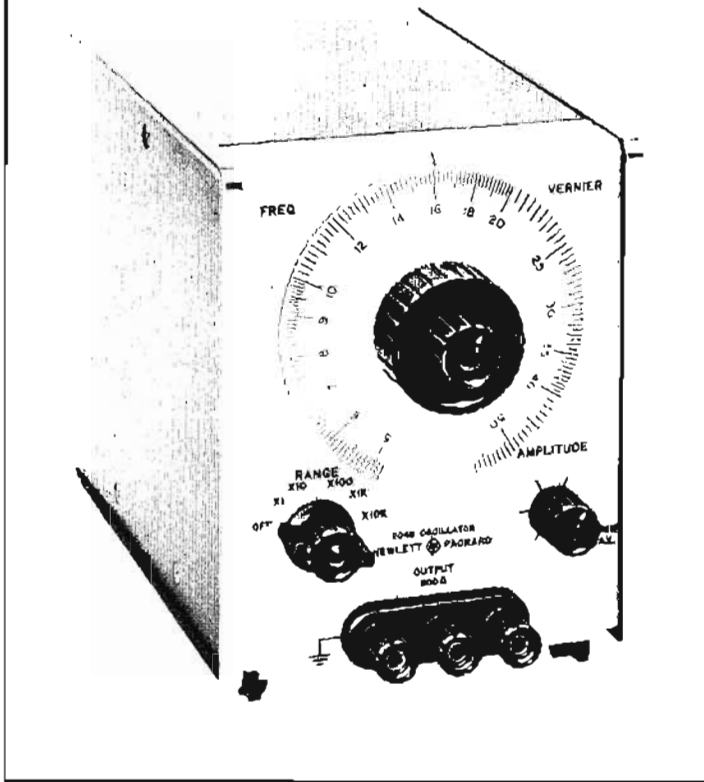

Solid State, Battery-Operated,
5 CPS to 560 KC,
Floating Output

Specifications

Fully solid state and battery-operated, *hp* 204B Oscillator is extremely useful for both field and laboratory work. Internal heat production is small, resulting in unusually low warmup drift. Stable, accurate signals are instantly available over a frequency range from 5 cps to 560 kc.

Balanced and unbalanced loads, and loads referenced either above or below ground, can be driven by the versatile Model 204B. Its output is fully floating, isolated from power line ground and instrument chassis. Completely balanced output is easily obtained with a simple external matching network. There is excellent frequency stability even with rapidly changing loads; low impedance circuits drive the 600 ohm output, effectively isolating the oscillator stage. Stability is typically better than 5 parts in 10^3 .

Flat frequency response of Model 204B provides further convenience of operation. At all settings of the dial and range switch the output is flat within $\pm 3\%$.

The small size, light weight and battery operation make *hp* 204B a portable oscillator which can easily be carried in one hand. This oscillator is an excellent companion for *hp* 403A or 403B, battery-operated voltmeters. In Model 204B the *hp*-developed RC oscillator bridge is tuned by a variable resistance; range switching uses precision fixed capacitors.

The modular *hp* cabinet allows easy access to the instrument chassis and makes an attractive, practical unit for portable or bench use. A rack mount adapter (see pages 18, 19) holds three Model 204B Oscillators or other instruments of the Hewlett-Packard modular design.

Frequency Range: 5 cps to 560 kc, in 5 ranges. 5% overlap between ranges, vernier control.

Dial Accuracy: $\pm 3\%$.

Frequency Response: $\pm 3\%$, with rated load.

Output Impedance: 600 ohms.

Output: 10 milliwatts (2.5 v rms) into 600 ohms; 5 v rms open circuit. Completely floating.

Output Control: Continuously variable bridged "T" attenuator with at least 40 db range.

Distortion: Less than 1%.

Noise: Less than 0.05% ac or battery operated.

Power Source: 4 battery cells at 6.75 volts each, 7 ma drain, life at least 300 hours.

Dimensions: Module 6-3/32" high, 5 1/8" wide, 8" deep.

Weight: Net 6 lbs. Shipping 9 lbs.

Accessory Available: 204B-11A AC Supply Kit for field installation, \$55; 204B-64B Battery Kit for field installation, \$25.

Price: \$315 (with batteries). Option: 01. AC power pack installed in lieu of batteries, add \$25.

Data subject to change without notice.



241A PUSH-BUTTON OSCILLATOR

Three-Digit Frequency Resolution, 10 CPS to 1 MC

Advantages:

- Three-digit frequency resolution
- Flat response 10 cps to 1 mc
- Simple, rapid frequency selection
- Compact, lightweight, portable

Push-button convenience and repeatability for selecting frequencies from 10 cps to 999 kc make the 241A Oscillator ideal for supplying stable test signals for laboratory or production work. Simple depression of three frequency buttons and one of five decade multipliers selects any of 4500 discrete frequencies. Accuracy is $\pm 1\%$, and repeatability is typically better than 0.02%.

Three-digit frequency resolution is provided, with interpolation possible with a vernier control that extends the upper frequency to 1 mc. Because the 241A uses special, fixed precision resistors and large amounts of negative feedback in a unique biased-diode control circuit, frequency response is flat within $\pm 2\%$ over the entire range at any attenuator setting. A front panel control adjusts the bridged-tee attenuator for output levels of -30 dbm to $+10$ dbm, presenting a constant output impedance of 600 ohms. The attenuator, capacitively decoupled from the amplifier circuit, eliminates the need for a dc balance adjustment at the output.

Hum and noise are reduced below 0.05% of the output by the use of low impedance solid-state circuitry, shielded power supply transformer and floating output. These fea-

tures not only isolate the oscillator from stray field pickup, but also allow the use of the instrument in environments where test setups themselves are subject to pickup. The solid-state design, which contributes to superior stability, inhibits the effect of shock or vibration that is often present in test areas.

Operator fatigue is reduced by highly visible, white-on-black push buttons, and frequency ambiguity is prevented by mechanical interlocks which keep any two push buttons in the same row from being depressed together.

Specifications

- Frequency Range: 10 cps to 1 mc, 5 ranges, 900 frequency increments per range with vernier overlap.
- Calibration Accuracy: $\pm 1\%$.
- Frequency Response: $\pm 2\%$ into rated load.
- Output Impedance: 600 ohms.
- Distortion: 1% maximum.
- Hum and Noise: 0.05% of output.
- Output: $+10$ to -30 dbm into 600 ohms (2.5 v max).
- Power: 115 or 230 volts, 50 to 1000 cps, 1 watt.
- Dimensions: 6 1/2" high, 7-25/32" wide, 8" deep.
- Weight: Net 8 lbs. Shipping 13 lbs.
- Price: \$425.

Data subject to change without notice.

NEW IN THIS CATALOG

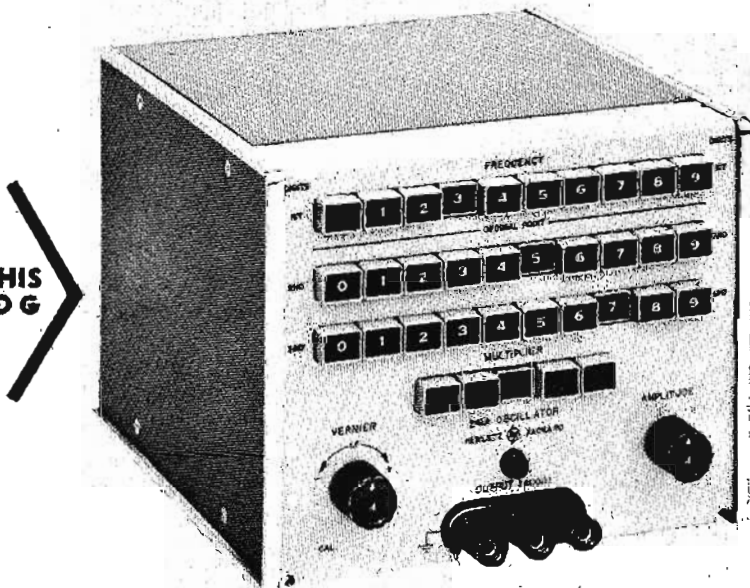

241A

hp 200J, 200T, 233A SPECIAL PURPOSE OSCILLATORS

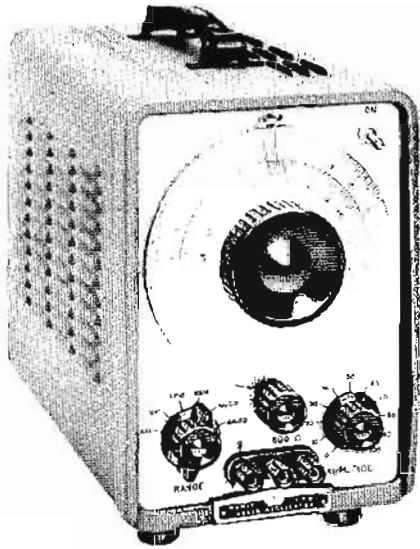

Ⓜ 200J

Ⓜ 200J Interpolation Oscillator Maximum Band Spread, 6 CPS to 6 KC

This ultra-precision instrument is engineered for interpolation and frequency measurements where frequencies must be known with extreme accuracy. Covering the range 6 cps to 6 KC, Model 200J offers an output of 160 mw or 10 volts into 600 ohms, or 20 volts open circuit, balanced to ground. Distortion is less than 0.5%, and frequency stability is $\pm 2.0\%$ or 0.2 cps. The instrument has 6 spread scale frequency ranges, and an effective scale length of 80" for maximum resettability. Calibration accuracy is $\pm 1.0\%$, and frequency response is ± 1 db full range. Hum voltage is less than 0.1% of output. Power source, 115 or 230 v $\pm 10\%$, 50 to 1,000 cps, 110 watts. Cabinet mount, 7 $\frac{3}{8}$ " wide, 11 $\frac{1}{2}$ " high, 14 $\frac{1}{4}$ " deep. Rack mount, 19" wide, 7" high, 12 $\frac{7}{8}$ " deep behind panel. Weight: cabinet mount, net 22 lbs., shipping 27 lbs.; rack mount, net 27 lbs., shipping 37 lbs. Ⓜ 200J, \$350.00 (cabinet); Ⓜ 200JR, \$355.00 (rack mount).

Ⓜ 200T Telemetry Oscillator High Stability, Resolution; 250 CPS to 100 KC

Model 200T provides the highest possible frequency stability in a wide range, convenient commercial audio oscillator. It is particularly useful for precise, high resolution frequency checking applications such as the evaluating of telemetering circuits, determination of carrier current equipment operation, and measurement of characteristics of sharply tuned filters. Model 200T covers frequencies 250 cps to 100 KC in 5 ranges, with good overlap between bands; output is 160 mw or 10 volts into 600 ohms, or 20 volts open circuit. Calibration accuracy $\pm 1\%$ long term, frequency response ± 1 db full range. High stability, distortion less than 0.5% full range. Hum and noise less than 0.03% of rated output. Power source, 115 or 230 v $\pm 10\%$, 50 to 1,000 cps, approx. 160 watts. Cabinet mount 18 $\frac{3}{4}$ " wide, 9-3/16" high, 11 $\frac{3}{4}$ " deep. Rack mount 19" wide, 8 $\frac{3}{4}$ " high, 10-15/16" deep behind panel. Weight: cabinet mount, net 27 lbs.; shipping 36 lbs.; rack mount, net 28 lbs., shipping 36 lbs. The instrument is compact, versatile, simple to operate. It covers IRIG (RDB) channels 1 through 18 and no channel is split by bandswitching. Ⓜ 200T, \$500.00 (cabinet); Ⓜ 200TR, \$505.00 (rack mount).

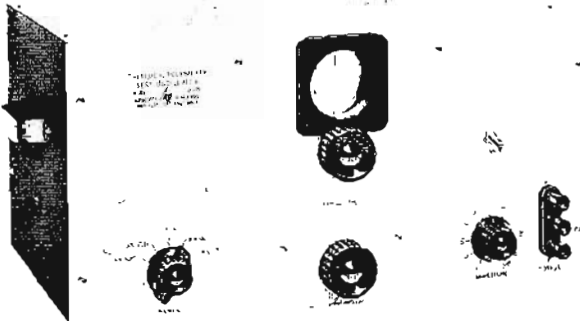

Ⓜ 200T

Ⓜ 233A Carrier Test Oscillator Checks Systems, 50 CPS to 500 KC

This Ⓜ oscillator was designed specifically for checking carrier current systems, and covers frequencies 50 cps to 500 KC in 4 bands. It provides a high power output of 3 watts into a 600 ohm balanced load, making possible tests over loops 100 to 200 miles long. A second output of 6 volts into 600 ohms is available for audio tests (one terminal to ground). The instrument contains a voltmeter which monitors output power. Provisions are made for modulating the carrier so that communications are available on the carrier to facilitate tests. Frequency stability is $\pm 2\%$ including warmup; frequency response (3 w output) ± 1 db, 5 to 500 KC; (6 v output) ± 1 db, 50 cps to 500 KC. Distortion less than 1% to 100 KC; hum voltage less than 0.1% at full output. Power source, 115 or 230 v $\pm 10\%$, 50 to 1,000 cps, approx. 185 watts. Cabinet mount, 17 $\frac{1}{4}$ " wide, 11" high, 15" deep. Weight: net 39 lbs., shipping 48 lbs. Price, Ⓜ 233A, \$650.00.

Data subject to change without notice.

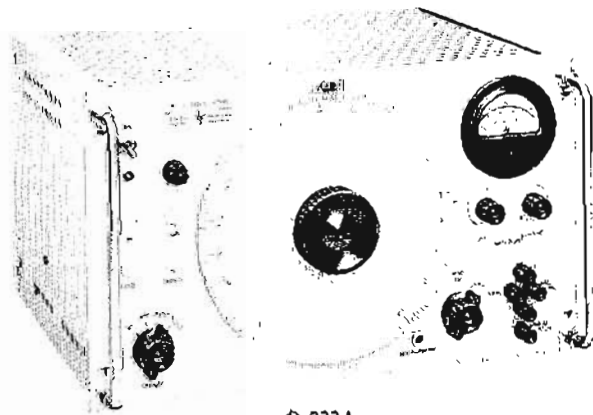

Ⓜ 233A

202A LOW FREQUENCY FUNCTION GENERATOR

Transient-Free Voltages 0.008 CPS to 1200 CPS;
Sine-Square-Triangular Waveforms

The *hp* 202A Low Frequency Function Generator is a compact, convenient, multi-purpose source of transient-free test voltages. It is particularly useful for testing servo, geophysical and medical equipment, and for the electrical simulation of mechanical phenomena.

Output frequency is continuously variable from 0.008 cps to 1200 cps in 5 bands. Model 202A offers exceptional stability and distortion of less than 1% over most of the band. Any of three desired waveforms—sine, square or triangular—may be selected by a front panel switch. Output is high—30 volts peak-to-peak—for all three waveforms and is essentially constant over the entire frequency range.

The *hp* 202A differs from conventional low-frequency oscillators in that the sine wave is electronically synthesized. A controlled bi-stable circuit generates a rectangular wave. This wave is passed through a special integrator providing a true triangular wave.

The triangular wave then enters a shaping circuit designed exclusively for this equipment. In this circuit, 12 crystal diodes modify or "shape" the wave and provide a sine wave. This sine wave has a distortion of less than 1%, and the synthesizing circuit provides virtually transient-free output even when frequency and operating conditions are rapidly varied. It is not necessary to wait long periods of time for the circuits to stabilize as is the case with conventional low frequency oscillators. The circuit inherently maintains constant amplitude over the entire frequency range.

The output system of *hp* 202A is fully floating with respect to ground and may be used to supply a balanced voltage or an output voltage with either output terminal grounded. The equipment will deliver 10 volts rms into a load of 4,000 ohms or greater. Internal impedance is only 40 ohms. There are no coupling capacitors in the output system, and a high degree of dc balance is achieved by the special circuitry.

Specifications

Frequency Range: 0.008 to 1200 cps in five decade ranges.

Dial Accuracy: 2% from 1.2 to 12; 3% from 0.8 to 1.2.

Frequency Stability: Within 1%, including warmup drift and line voltage variations of $\pm 10\%$.

Output Waveforms: Sinusoidal, square and triangular.

Maximum Output Voltage: At least 30 volts peak-to-peak across rated load (4000 ohms) for all three waveforms.

Internal Impedance: Approx. 40 ohms over entire range.

Sine Wave Distortion: Less than 1% on x0.01, x0.1, x1, and x10 ranges; less than 2% on x100 range.

Output System: Output is isolated from ground, and either side may be grounded. Output system is direct coupled; dc level of output remains stable over long periods of time and can be adjusted to zero by a front panel control.

Frequency Response: Constant within 0.2 db.

Hum Level: Less than 0.05% of maximum output.

Sync Pulse: 10 volts peak negative, less than 5 μ sec duration. Sync pulse occurs at crest of sine and triangular wave output.

Power: 115 or 230 v $\pm 10\%$, 50 to 1000 cps, approx. 150 watts.

Dimensions: Cabinet Mount: 20 $\frac{3}{4}$ " wide, 12 $\frac{3}{4}$ " high, 14 $\frac{5}{8}$ " deep. Rack Mount: 19" wide, 10 $\frac{1}{2}$ " high, 13" deep.

Weight: Net 42 lbs. Shipping 52 lbs. (cabinet); Net 37 lbs. Shipping 46 lbs. (rack mount).

Accessories Available: *hp* 11000A Cable Assembly, \$4.50; *hp* 11001A Cable Assembly, \$5.50.

Price: *hp* 202A, \$550 (cabinet); *hp* 202AR, \$535 (rack mount).

Data subject to change without notice.

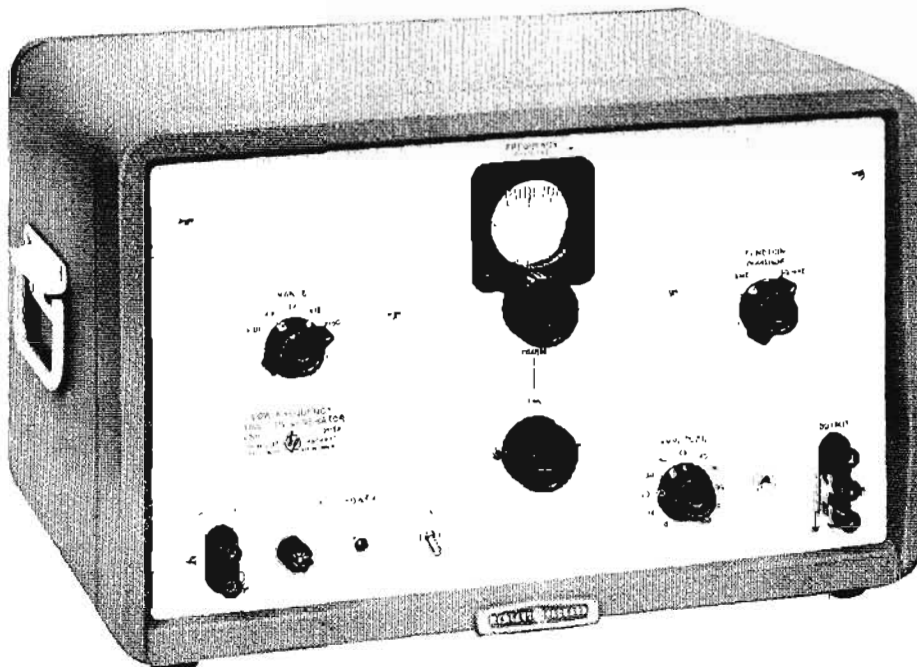

hp 205AG AUDIO SIGNAL GENERATOR

Six Basic Instruments Combined to Speed Gain Measurements

This Audio Signal Generator materially speeds and simplifies a variety of audio testing jobs where sizable amounts of power are required.

Two voltmeters measure input and output of the device under test. The output level is adjusted by means of the step attenuators and output impedance can be instantly changed by means of a selector switch to commonly used impedances.

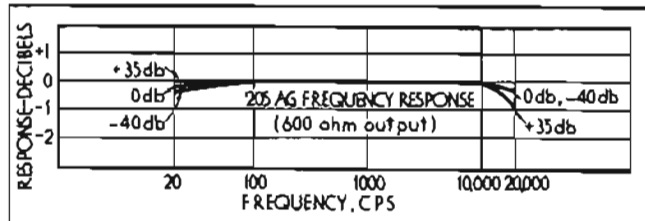

Figure 1. Typical frequency response of Φ 205AG output section. (Response of attenuator and line matching transformer.)

Specifications

Frequency Range: 20 cps to 20 KC in three decade ranges.

Calibration Accuracy: $\pm 2\%$ under normal temperature conditions.

Output: Five watts maximum into loads of 50, 200, 600 and 5,000 ohms. Output circuit is balanced and center-tapped; any terminal may be grounded.

Frequency Response: ± 1 db, 20 cps to 20 KC at output levels up to $+30$ dbm with output meter reading held at $+37$ db; ± 1.5 db, 20 cps to 20 KC at output levels above $+30$ dbm with output meter reading held at $+37$ db (reference 1,000 cps).

Internal Impedances: Approximately $1/6$ of the load impedance with zero attenuator setting. Approaches the load impedance with attenuator settings of 20 db or more.

Distortion: Less than 1% at frequencies above 30 cps.

Hum Level: The hum level is 60 db below the output voltage or 90 db below 0 dbm, whichever is the larger.

Output Meter: Calibrated directly in volts at 600 ohms and dbm (0 dbm = 1 mw in 600 ohms).

Voltage Scale: 0-65 volts, db scale $+20$ to $+37$ dbm.

Input Meter: Calibrated in dbm from -5 to $+8$ dbm and in volts from 0 to 2 volts rms. Voltage accuracy is $\pm 5\%$ of full scale.

Input Attenuator: Extends meter range to $+48$ dbm and to 200 volts rms in 5 db steps. Accuracy ± 0.1 db. Input impedance 5,000 ohms.

Output Attenuator: 110 db in 1 db steps.

Power: 115 or 230 v $\pm 10\%$, 50 to 1,000 cps, 150 watts.

Dimensions: Cabinet Mount: $20\frac{3}{4}$ " wide, $12\frac{3}{4}$ " high, $15\frac{1}{2}$ " deep. Rack Mount: 19" wide, $10\frac{1}{2}$ " high, 14" deep behind panel.

Weight: Net 56 lbs. Shipping 67 lbs. (cabinet mount). Net 49 lbs. Shipping 63 lbs. (rack mount).

Accessories Available: 11000A Cable Assembly, \$4.50; 11001A Cable Assembly, \$5.50.

Price: Φ 205AG, \$600.00 (cabinet); Φ 205AGR, \$585.00 (rack mount).

Data subject to change without notice.

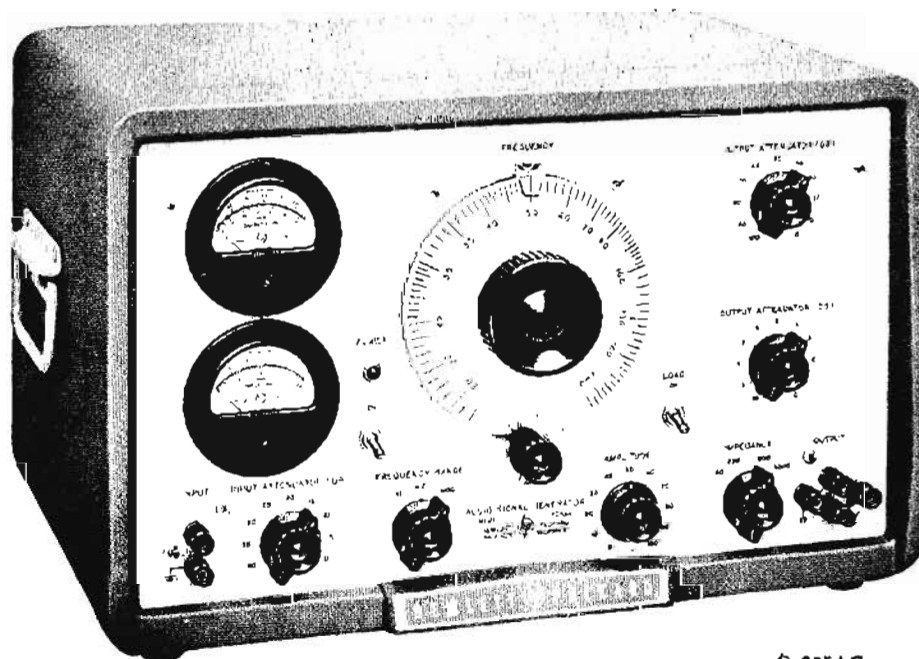

Φ 205AG

hp 206A AUDIO SIGNAL GENERATOR

Continuously Variable Audio Signals; Less Than 0.1% Distortion

Specifications

The hp Model 206A Audio Signal Generator provides a source of continuously variable audio frequency voltage at a total distortion level of less than 0.1%. This unusually low distortion, coupled with simple, straightforward circuitry, rugged construction and typical hp ease of operation, makes this signal generator ideal for use in the maintenance of FM broadcasting units and high fidelity audio systems.

The oscillator section is followed by a tuned amplifier, automatically tracked with the oscillator. High selectivity of the amplifier reduces the harmonic voltages generated by the oscillator section.

The output of the amplifier is measured by a voltmeter. Indications can be read in either volts or dbm to an accuracy of 0.2 db. Following the vacuum tube voltmeter is a 111 db attenuator which allows the power output to be varied in 0.1 db steps.

Uses

This instrument is suitable for FM transmitter maintenance, studio amplifier and console testing, as a low distortion source for bridge measurements, and as a transmission measuring set.

Data subject to change without notice.

Frequency Range: 20 cps to 20 KC in three decade ranges.
Calibration Accuracy: $\pm 2\%$ including warmup drift.

Output: +15 dbm into impedances of 50, 150 and 600 ohms. Approximately 10 volts are available into an open circuit.

Output Impedances: The generator has a matched internal impedance and the selection of output impedances includes 50, 150 and 600 ohms center-tapped and balanced and 600 ohms single ended.

Frequency Response: Better than ± 0.2 db at all levels, 30 cps to 15 KC, when the output meter reading is held constant.

Distortion: Less than 0.1% at frequencies above 50 cps and less than 0.25% from 20 cps to 50 cps.

Hum Level: At least 75 db below the output signal or more than 100 db below zero level, whichever is the larger.

Output Meter: Calibrated in dbm and also in volts. Readability at least 0.2 db at all points above a 50% scale reading. (0 dbm equals 1 mw in 600 ohms.)

Output Attenuators: 111 db in 0.1 db steps.

Power: 115 or 230 v $\pm 10\%$, 50 to 1,000 cps, 140 watts.

Dimensions: Cabinet Mount: 20 $\frac{3}{4}$ " wide, 12 $\frac{3}{4}$ " high, 15" deep. Rack Mount: 19" wide, 10 $\frac{1}{2}$ " high, 14" deep behind panel.

Weight: Net 57 lbs. Shipping 67 lbs. (cabinet mount).

Net: 50 lbs. Shipping 63 lbs. (rack mount).

Accessories Available: 11000A Cable Assembly, \$4.50; 11001A Cable Assembly, \$5.50.

Price: hp 206A, \$900.00 (cabinet); hp 206AR, \$885.00 (rack mount).

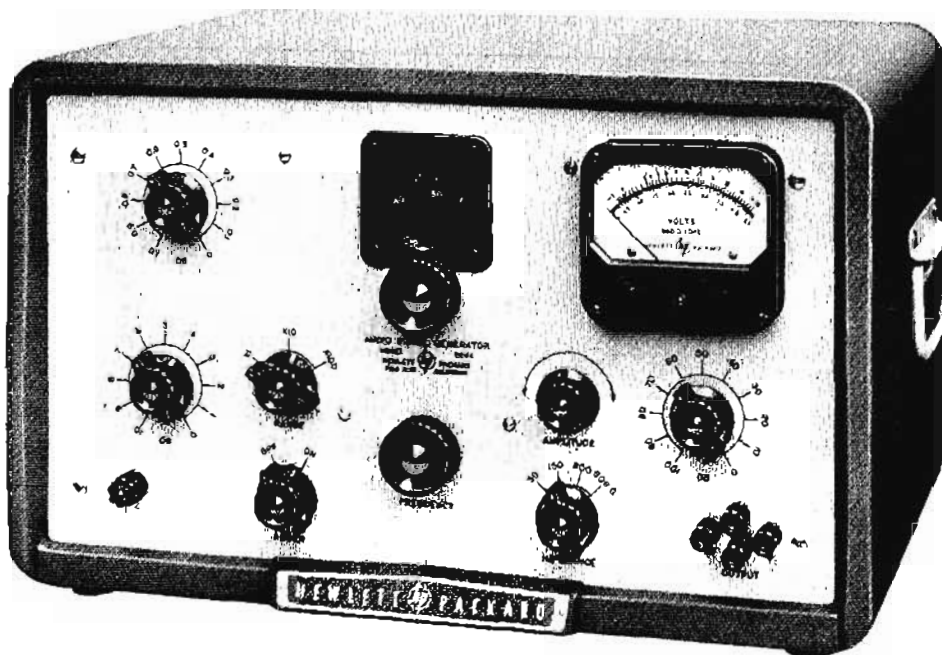

hp 206A

650A TEST OSCILLATOR

Fast, Accurate Tests 10 CPS to 10 MC

The 650A Oscillator brings audio frequency speed, accuracy and ease of operation to higher frequency fields. Its wide frequency range, 10 cps to 10 mc, makes it ideal for a wide variety of measurements in audio, ultrasonic, video and rf bands. Output is flat within ± 1 db throughout its frequency range. Voltage range is 30 microvolts to 3 volts, and output impedance is 600 ohms. For measurements where low source impedance is desired, an output voltage divider provides a 6 ohm impedance.

Six decade frequency ranges provide an effective scale length of 94 inches. The tuning dial is controlled directly, or with a 6 to 1 vernier microdrive for hairline adjustment.

The output voltage is monitored by a vacuum tube voltmeter which measures the voltage at the input to the attenuator system. The vtvm is calibrated in volts and decibels and reads actual output voltage when the attenuators are set for zero attenuation. For other attenuator settings true output voltage is obtained by subtracting the attenuator reading from the output voltmeter reading. The output attenuator is adjustable in 10 db steps, and maximum attenuation is 50 db.

Circuits of the *hp* Model 650A have been carefully proportioned and low temperature coefficient components have been employed to assure highest frequency stability. Output voltage will remain constant over long periods of time, despite wide variations in temperature. Distortion over the low frequency bands is kept at a minimum to increase the usefulness of the instrument for audio measurements.

Specifications

Frequency Range: 10 cps to 10 mc; six decade bands.
Calibration Accuracy: $\pm 2\%$, 10 cps to 100 kc; $\pm 3\%$, 100 kc to 10 mc (including warmup and $\pm 10\%$ line voltage variation).
Output: 15 milliwatts or 3 volts into 600 ohm resistive load. Open circuit voltage is at least 6 volts.
Source Impedance: 600 ohms; 300 ohms or 6 ohms when using *hp* 11020A Output Divider Cable.
Frequency Response: Flat within ± 1 db, 10 cps to 10 mc into 600 ohm resistive load.
Distortion: Less than 1% from 20 cps to 100 kc; less than 2% from 100 kc to 1 mc; approximately 5% at 10 mc.
Output Monitor: Vacuum tube voltmeter monitors level at input to attenuator, in volts or db at 600-ohm level. Zero db = 1 mw in 600 ohms. Accuracy $\pm 5\%$ of full scale reading.
Output Attenuator: 0 to 50 db in 10 db steps, providing continuously variable output voltage from +12 dbm to -50 dbm, 3 volts to 3 millivolts, or down to 30 microvolts with voltage divider. Accuracy ± 1 db into resistive load of 600 ohms.
Hum Voltage: Less than 0.5% of output voltage with meter at full scale.
Power: 115 or 230 v $\pm 10\%$, 50 to 1000 cps, 165 watts.
Dimensions: Cabinet Mount: 20 $\frac{3}{4}$ " wide, 12 $\frac{3}{4}$ " high, 15" deep.
Rack Mount: 19" wide, 10 $\frac{1}{2}$ " high, 15" deep behind panel.
Weight: Net 46 lbs. Shipping 55 lbs. (cabinet mount). Net 37 lbs. Shipping 52 lbs. (rack mount).
Accessories Furnished: One *hp* 11020A Output Divider Cable.
Accessories Available: *hp* 11000A Cable Assembly, \$4.50; *hp* 11001A Cable Assembly, \$5.50.
Price: *hp* 650A, \$550 (cabinet); *hp* 650AR, \$535 (rack mount).

Data subject to change without notice.

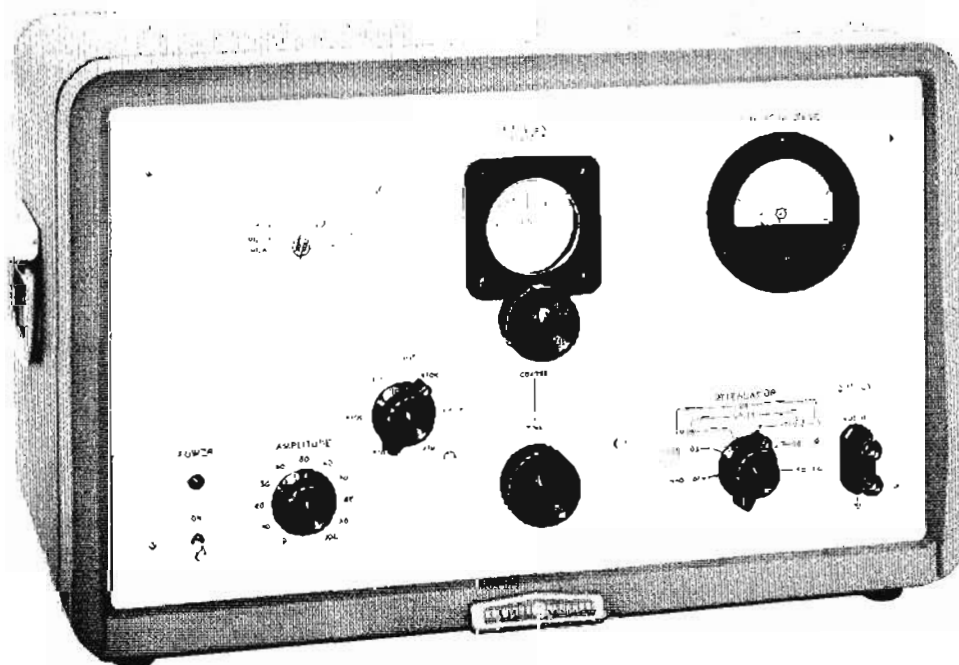

WAVE AND DISTORTION ANALYZERS

The choice between a wave analyzer and distortion analyzer depends on the kind of information desired. The wave analyzer is a narrow-band filter which is tuned to select and measure the strength of the individual components of a signal one at a time. (Fig. 1) This is in contrast to the distortion analyzer, which is a narrow-band rejection filter, tuned to remove the fundamental frequency so that the amplitude of the remaining components can be measured all at once (Fig. 2). The distortion analyzer is used for fast, quantitative measurements of total distortion, whereas the wave analyzer provides detailed information concerning each harmonic and intermodulation product.

A signal becomes distorted whenever it passes through a non-linear circuit or network. Percentage distortion is defined as 100 times the ratio of the root mean square sum of the harmonics to the fundamental*.

$$\% \text{ distortion} = \frac{(A_2^2 + A_3^2 + A_4^2 + \dots)^{1/2}}{A_1} \times 100$$

where A_1 is the rms amplitude of the fundamental and A_2, A_3, A_4, \dots are the amplitudes of the individual harmonics.

The Distortion Analyzer

The distortion analyzer, typified by the *hp* 330 series, measures total rms distortion and provides a ready determination of percentage distortion. The procedure is fast and easy. The analyzer is first switched to the "Set Level" function, which converts the instrument to a broadband voltmeter. The instrument's attenuators and amplifier gain then are adjusted to place the indicating meter's pointer on a reference mark. The function switch next is set to "Distortion", which places the rejection filter in the circuit. The operator tunes the filter

to eliminate the fundamental frequency of the input signal, as noted by a dip in the meter's reading. The instrument now reads the rms sum of the remaining harmonic components, the attenuator being readjusted to bring the pointer up-scale.

The instrument is calibrated so that the final reading, referenced to the attenuator setting, shows percentage distortion directly or it can show distortion in terms of db units. This distortion, strictly speaking, is presented as the ratio of the rms sum of the harmonics to the rms value of the *total* wave, not to just the fundamental as shown in the equation. In the range where this instrument is used, however, the difference between this ratio and actual percentage distortion as defined previously is small, the difference being less than 1/2% for harmonic distortion as high as 10%.

The Wave Analyzer

The wave analyzer, as implied previously, is a highly selective voltmeter. In operation, a front panel control is tuned to the frequency of the harmonic component to be measured and the harmonic's voltage amplitude is then read directly on the front panel meter. This information is useful, for instance, in analyses of waveforms obtained from vibration systems, where system resonance can be pinpointed by the presence of larger than normal harmonic components.

Hewlett-Packard wave analyzers are heterodyning tuned voltmeters, which means simply that the input signal is heterodyned to a higher intermediate frequency by an internal local oscillator.

*See Hewlett-Packard Application Note 15, "Distortion and Intermodulation," for a more complete discussion.

Filtering is performed in the IF amplifiers so that the instrument's pass-band remains constant regardless of the instrument's tuning. Tuning the local oscillator shifts the various input signal frequency components into the pass-band of the IF amplifiers. The output of the IF amplifiers is rectified and supplied to the metering circuit.

A Hewlett-Packard designed and built tuning capacitor is used in the oscillator circuits. This capacitor provides a linear rotation vs. frequency characteristic which facilitates tuning, since the distance between frequency increments on the dial is constant throughout the tuning range of the instrument. With this tuning characteristic, close-spaced harmonics are separated as easily at the high end of the tuning range as at the low range.

Two attenuators insure that low level harmonic content can be read with accuracy. The input attenuator is set according to the amplitude of the input signal, allowing maximum input amplitude without overloading of the linear amplifiers and modulator. The second attenuator, in the metering circuit, permits the amplitudes of harmonic components to be read with accuracy throughout a 75 db range.

Automatic frequency control, an important feature of the new *hp* wave analyzers, greatly facilitates wave analysis. Because of the narrow bandpass of these instruments (less than 7 cps in the model 302A), harmonic components are likely to drift out of the pass-band during measurement. The automatic frequency control locks the instrument's tuning to the frequency of the harmonic component, so that measurements are not affected by drift in the source signal.

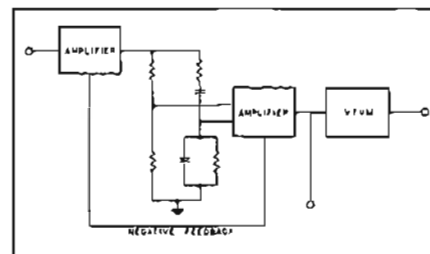
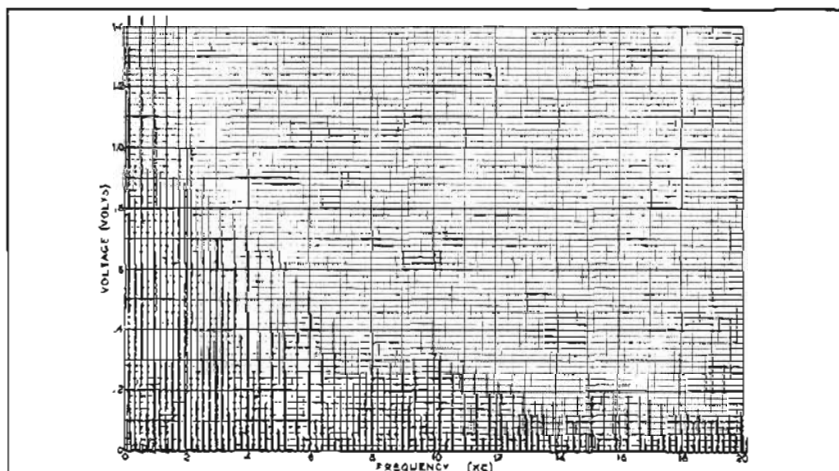

Figure 2. Block diagram of HP 330B Distortion Analyzer.

Figure 1. Harmonic analysis of slightly unsymmetrical square wave. Several harmonics were allowed to run off scale so the smaller, higher order harmonics are clearly visible.

hp 302A WAVE ANALYZER

Highly Selective, Transistorized, Measures Wave Components Directly

Advantages.

- No calibration or stabilization needed
- Direct readings; accurate
- Measures frequencies 20 cps to 50 KC
- Completely transistorized
- Battery or ac powered; hum free
- Low power consumption; no warmup needed
- Very sharp acceptance circuits
- AFC; also frequency restorer circuit
- Compact, rugged, versatile
- Oscillator-tuned voltmeter

Uses:

Measures and analyzes fundamentals, harmonics, and intermodulation products in telemetering, carrier and vibration systems as well as audio circuits. Speeds analysis of noise and broadcast amplifier characteristics; modulation amplifier, film sound track and recording distortion; hum, network characteristics, etc.

Model 302A Wave Analyzer is a significant improvement in wave analyzer design. It obviates the need for tedious calibration procedures and stabilization before use, has sharp acceptance circuits, is completely solid state, compact and easy to operate.

Other exceptional features are extremely narrow bandwidth, automatic frequency control, automatic tracking when used as an oscillator tuned-voltmeter, provision for battery operation (18 to 28 volts) as well as ac line power, and elimination of warmup time.

Simple Operation

In operation the instrument functions as a highly selective tuned voltmeter. A front panel control selects the frequency to be measured and voltage is then read directly on the front panel meter.

Model 302A separates the input signal into its individual components so that each—the fundamental, harmonics and any intermodulation products—may be evaluated separately.

The instrument operates by mixing the input signal with an internal oscillator adjusted to provide a difference frequency of 100 KC. An automatic frequency control circuit maintains a constant difference frequency between the input and oscillator signals. This insures accurate measurements despite frequency drift in the input signal. After the input signal is mixed with a voltage from the internal oscillator the 100 KC difference signal is passed through a narrow-band crystal filter, amplified and metered.

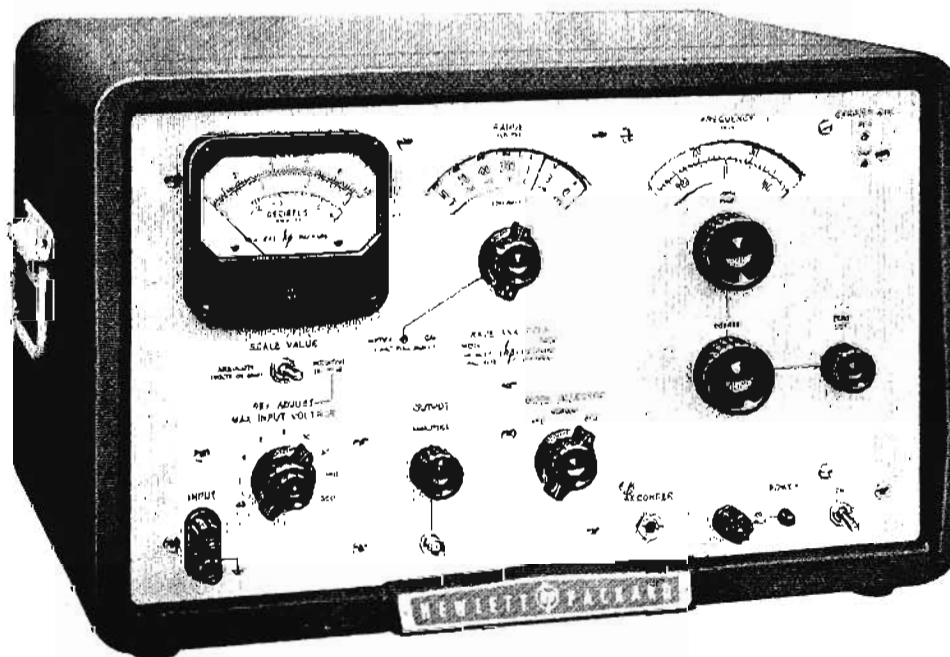

Frequency Restorer

A frequency restorer circuit makes accurate frequency measurements possible at each component frequency of the input wave. The frequency restorer circuit supplies a sinusoidal signal at the frequency of the specific component to which the $\text{\textcircled{P}}$ 302A is tuned. This signal can be measured on an electronic counter or observed on an oscilloscope. The amplitude of the restorer signal is determined by the level of the selected component. When the mode selector switch is in the normal or AFC position, the signal appears at the output terminals if the meter is indicating.

Model 302A is also particularly useful for measuring small signals on noisy systems or transmission lines. When the mode selector is switched to "BFO" the instrument becomes an oscillator and tuned voltmeter automatically tuned by one control to the same or oscillator frequency. The selective tuned voltmeter then discriminates against the noise and measures the desired signal.

Speed and accuracy of measuring is enhanced by a linearly calibrated tuning control giving the same "tuning feel" throughout range.

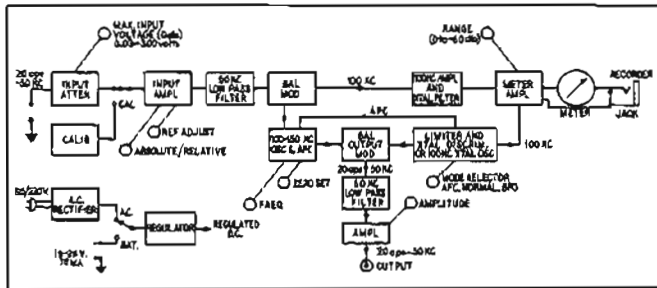

Figure 1. Block diagram, Model 302A Harmonic Wave Analyzer.

Specifications $\text{\textcircled{P}}$ 302A

- Frequency Range:** 20 cps to 50 KC.
- Frequency Calibration:** Linear graduation 1 division per 10 cycles. Accuracy $\pm (1\% + 5 \text{ cps})$.
- Voltage Range:** 30 μv to 300 v full scale in a 30, 100, 300 sequence. Steps of 1:3 or 10 db. Meter range indicated by a dial mechanically linked to input attenuator. An absolute-relative switch provides for adjustment of intermediate values.
- Warmup-Time:** None.
- Voltage Accuracy:** $\pm 5\%$ of full scale value.
- Residual Modulation Products and Hum Voltage:** Greater than 75 db down.
- Intermediate Frequency Rejection:** Intermediate frequency present in input signal rejected by at least 75 db.
- Selectivity:** $\pm 3\frac{1}{2}$ cycle b.w.—at least 3 db down
 ± 25 cycle b.w.—at least 50 db down
 ± 70 cycle b.w.—at least 80 db down
 beyond ± 70 cycle b.w.—at least 80 db down
- Input Impedance:** Determined by setting of input attenuator: 100,000 ohms on 4 most sensitive ranges, 1 meg-ohm on remaining ranges.
- Restored Frequency Output:** 1 v across 600 ohms at output terminals for full scale meter deflection. Output level control provided. Frequency response $\pm 2\%$, 20 cycles to 50 KC. Output impedance approximately 600 ohms.
- Oscillator Output:** 1 v across 600 ohms at output terminals (mode selector in B.F.O.). Output level control provided. Frequency response $\pm 2\%$, 20 cps to 50 KC. Output impedance approximately 600 ohms.
- Recorder Output:** 1 ma dc into 1,500 ohms or less at full scale meter indication, for ungrounded recorders only.
- Automatic Frequency Control:** Range of frequency holdin is ± 100 cycles minimum.

Power: 115 or 230 v $\pm 10\%$, 50 to 1600 cycles, 3 watts (approximately). Terminals provided for powering instrument from external battery source. Battery supply range 28 v to 18 v.

Weight: Net 43 lbs. Shipping 51 lbs. (cabinet mount).
 Net 35 lbs. Shipping 51 lbs. (rack mount).

Dimensions: Cabinet Mount: 20 $\frac{3}{4}$ " wide; 12 $\frac{1}{2}$ " high; 14 $\frac{1}{2}$ " deep. Rack Mount: 19" wide; 10 $\frac{1}{2}$ " high; 13 13/16" deep behind panel.

Price: $\text{\textcircled{P}}$ 302A, \$1,800.00 (cabinet); $\text{\textcircled{P}}$ 302AR, \$1,785.00 (rack mount).

$\text{\textcircled{P}}$ 297A Sweep Drive

The 297A is a motor drive unit designed to enhance the usefulness of the $\text{\textcircled{P}}$ 302A or 310A Wave Analyzer. With the 297A you may sweep through all or any part of the 302A range. Because the 297A produces an X-axis output, you may easily make semi-automatic plots of harmonics and intermodulation products. When an $\text{\textcircled{P}}$ Wave Analyzer is used as an oscillator tuned-voltmeter the 297A permits semi-automatic frequency response measurements of networks, amplifiers and filters even in the presence of high noise.

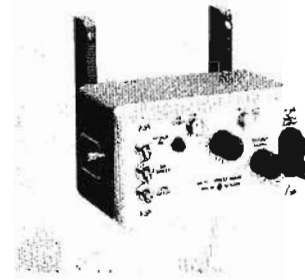

The 297A, although designed for use with the $\text{\textcircled{P}}$ 302A, also may be used to drive oscillators and other tunable devices through their ranges. A stand which allows the shaft height to be adjusted from 4 inches to 12 inches is available for adapting the 297A to other equipment.

Specifications $\text{\textcircled{P}}$ 297A

- Sweep Range:** 64 revolutions.
- Sweep Limits:** Any interval from 64 revolutions to 10 degrees.
- Sweep Speed:** With $\text{\textcircled{P}}$ 302A: 170 cps per second and 17 cps per second.
- Shaft Speed:** 10 rpm, 1 rpm, and neutral; quick change speed transfer without stopping. Neutral permits manual operation.
- Sweep Output:** At least 12 volts maximum. Change of output proportional to change in shaft position and zero output may be set for any shaft position. Full output may be obtained with 2.1 revolutions or with 50 revolutions of the output shaft. No sweep output when set to high speed, short sweep.
- Motor:** Reversible synchronous capacitor type reluctance motor; may be stalled indefinitely.
- Output Shaft:** $\frac{1}{4}$ inch diameter with adapter to 7/16 inch for $\text{\textcircled{P}}$ Model 302A.
- Starting and Running Torque:** 9 in. - oz. at 10 rpm. Friction clutch limits torque at 1 rpm to approximately 22 in. - oz.
- Power:** 115 volts $\pm 10\%$, 50 to 60 cps, 12 watts, running or stalled.
- Mount:** Mounts on front panel of $\text{\textcircled{P}}$ Model 302A or bench stand.
- Weight:** Net 3 $\frac{1}{2}$ lbs. (approx.) Shipping 8 lbs.
- Dimensions:** 3 $\frac{1}{2}$ " high, 7" wide, 5 $\frac{1}{4}$ " deep, shaft extends 13/16" behind case.
- Accessory Available:** 11505A Bench Stand, adjusts shaft height from 4 to 12", \$25.00.
- Price:** $\text{\textcircled{P}}$ 297A, \$350.00; $\text{\textcircled{P}}$ H03-297A for 230 v 50 cps operation, \$375.00.

Data subject to change without notice.

310A WAVE ANALYZER

Permits Easy Analysis of Fundamental,
Harmonics, Intermodulation Products

Advantages:

- Covers 1 kc to 1.5 mc with three input bandwidths
- High sensitivity of $10 \mu\text{v}$ full scale
- Wide dynamic range, over 75 db
- High frequency, voltage accuracy
- Continuous, linear tuning
- High input resistance
- Digital frequency readout
- Automatically tracks drifting signal
- Restored frequency output
- Carrier reinsertion oscillator
- Oscillator-tuned voltmeter operation
- All solid state with plug-in board construction

Uses:

- Analyze complex audio and rf waveforms
- Measure frequency response of filters, amplifiers
- Make long line telephone measurements
- Measure transmission line characteristics
- Analyze sonar signals
- Loop Gain Measurements

The *hp* 310A High Frequency Wave Analyzer separates an input signal so that the fundamental, harmonics, or intermodulation products can be analyzed. Any signal component between 1 kc and 1.5 mc may be selected for measurement. Additionally, a front panel Mode switch lets the 310A function as an efficient tuned voltmeter for accurately measuring relative or absolute signal levels, as a signal source for selective response measurements, and as either an AM receiver or carrier reinsertion oscillator for demodulating single side-band signals.

High sensitivity of $10 \mu\text{v}$ full scale, combined with the wide dynamic range of 75 db, allows measurements of both weak harmonic components down to $1 \mu\text{v}$ and strong signals up to 100 v. A switch above the input attenuator can be flipped from Absolute to Relative to permit signal readings at any arbitrary point on the meter for relative-strength measurements of harmonic components.

NEW IN THIS
CATALOG

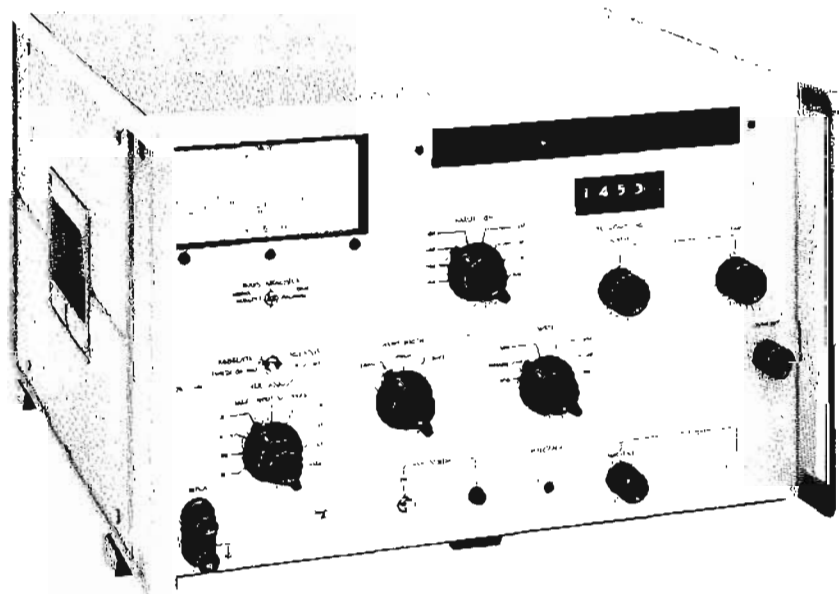

310A

Three Bandwidths

Three bandwidths, selected with a front-panel control, increase the versatility of the 310A. The 200-cps bandwidth discriminates between harmonics for exact identification. The 1-kc bandwidth simplifies calculations of noise power per cycle bandwidth. The 3-kc bandwidth admits carrier channel signals for evaluation and is wide enough to pass intelligible voice signals, but contributes so little noise that even the 10 μ v range can be used.

The 310A is extremely easy to use. To prevent ambiguity of reading, the voltage range corresponding to full scale sensitivity is automatically shown on an illuminated 15-place range indicator. Tuning is linear throughout the 310A's range, with no band switching. Frequency can be easily read from a 4-place digital dial which has a resolution of better than 200 cps over the entire band, with any setting accurate to $\pm (1\% + 300 \text{ cps})$.

AFC

An automatic frequency control has a dynamic hold-in range of $\pm 3 \text{ kc}$ (at 100 kc) with response rapid enough to lock signals with drift rates in excess of 100 cps/second.

Restored frequency output permits use of an electronic counter to measure the frequency to which the 310A is tuned. This output contains those input frequencies which fall within a selectable passband (200 cps, 1 kc, 3 kc) that is centered at the 310A's tuned frequency. (With the 310A tuned to 1 mc and the input bandwidth at 1 kc, restored frequency output contains all input components between 999.5 kc and 1000.5 kc.)

A dc output proportional to meter deflection also is available and can be used to drive a recorder.

Useful BFO Output

The output from the beat frequency oscillator is a sine wave that corresponds to the tuning indicator's setting, and it can be used effectively to make selective or narrow-band response tests on filter circuits and transmission systems. The BFO and tuned voltmeter are simultaneously controlled by the frequency indicator, tracking together, and can be conveniently used as a self-contained measuring system — the BFO output fed through a device under test, then back to the tuned voltmeter for analysis.

A carrier reinsertion oscillator is included to demodulate single sideband signals, either normal or inverted. The demodulated signal is available for aural or recording purposes.

Specifications

Frequency Range: 1 kc to 1.5 mc (200-cps passband).
5 kc to 1.5 mc (1000-cps passband).
10 kc to 1.5 mc (3000-cps passband).

Frequency Accuracy: $\pm (1\% + 300 \text{ cps})$.

Frequency Calibration: Linear graduation, 1 division/200 cps.

Selectivity: Nominal 200 cps bandwidth:
At least 3 db down at $\pm 108 \text{ cps}$.
At least 50 db down at $\pm 500 \text{ cps}$.
At least 75 db down at $\pm 1000 \text{ cps}^*$.

Nominal 1000 cps bandwidth:
At least 3 db down at $\pm 540 \text{ cps}$.
At least 50 db down at $\pm 2400 \text{ cps}$.
At least 75 db down at $\pm 5000 \text{ cps}^*$.

Nominal 3000 cps bandwidth:
At least 3 db down at $\pm 1550 \text{ cps}$.
At least 50 db down at $\pm 7000 \text{ cps}$.
At least 75 db down at $\pm 17,000 \text{ cps}^*$.

The midpoint of the passband is readily distinguished by a rejection region 1 cps wide.

Voltage Range: 10 μ volts to 100 volts full scale. Ranges provided by input attenuator and meter range switch in steps of 1:3 or 10 db.

Voltage Accuracy: $\pm 6\%$ full scale.

Internal Calibrator Stability: $\pm 1\%$ of full scale.

Dynamic Range: Greater than 75 db.

Input Resistance: Determined by input attenuator; 10K ohms on most sensitive range; 30K ohms on next range; 100K ohms on other ranges.

Noise and Spurious Response: At least 75 db below a full-scale reference set on the 0-db position of range switch.

Automatic Frequency Control: Dynamic hold-in range is $\pm 3 \text{ kc}$, minimum, at 100 kc. Tracking speed is approximately 100 cps/sec. Locks on signals as low as 70 db below a full-scale reference set on the 0-db position of the range switch.

Restored Frequency Output: Restored frequency output is at least 0.25 volts maximum across 135 ohms with approximately 30 db of level control provided. Output impedance, approximately 135 ohms.

BFO Output: 0.5 volt across 135 ohms with approximately 30 db of level control provided. Output impedance approximately 135 ohms.

Recorder Output: 1 ma dc into 1500 ohms or less for single-ended recorders.

Receiver Function (aural or recording provision): Internal carrier reinsertion oscillator is provided for demodulation of either normal or inverted single sideband signals. AM signal also can be detected.

Power: 115 or 230 volts $\pm 10\%$, 50 to 1000 cps; approximately 16 watts.

Dimensions: 16 $\frac{3}{4}$ " wide, 10 $\frac{1}{2}$ " high, 18 $\frac{3}{8}$ " deep. Hardware furnished converts panel to 10 $\frac{1}{4}$ " x 19" rack mount.

Weight: Net 44 lbs. Shipping 59 lbs.

Accessories Available: hp 297A Sweep Drive (see page 79), \$350.

Price: \$2000.

*Rejection decreases smoothly beyond the — 75 db points.

Data subject to change without notice.

hp 330B,C,D DISTORTION ANALYZERS

Accurate Distortion Readings 20 CPS to 20,000 CPS

Advantages:

- Blankets audio spectrum
- Measures noise as small as 100 μv
- High sensitivity, high stability
- Measures distortion as low as 0.1%
- Wide-band 20 db gain amplifier
- Oscilloscope terminals, built-in VTVM
- High-gain, wide-band amplification

The $\text{\textcircled{h}}$ Model 330B Distortion Analyzer will give you quick, accurate measurements of distortion as low as 0.1% at any frequency from 20 cps to 20,000 cps. It will make noise measurements of voltages as small as 100 microvolts. The analyzer has high sensitivity and high stability. Its circuit includes a 20 db amplifier, oscilloscope terminals and a precision vacuum tube voltmeter which is usable separately.

These many features give the instrument exceptional usefulness for all kinds of audio measurements in recording and motion picture facilities, broadcast studios, research laboratories and in maintaining quality of audio production.

Use It To Determine:

- Total audio distortion
- Voltage level, power output, gain
- Total distortion of AM rf carrier
- Noise and hum level
- Audio signal frequency

Model 330B Distortion Analyzer

Basically, $\text{\textcircled{h}}$ 330B Distortion Analyzer consists of a flat amplifier with slot rejection, a regulated power supply and a vacuum tube voltmeter.

The 20 db amplifier operates in conjunction with the $\text{\textcircled{h}}$ R-C tuned rejection circuit to provide nearly infinite attenuation at one frequency while allowing all other frequencies

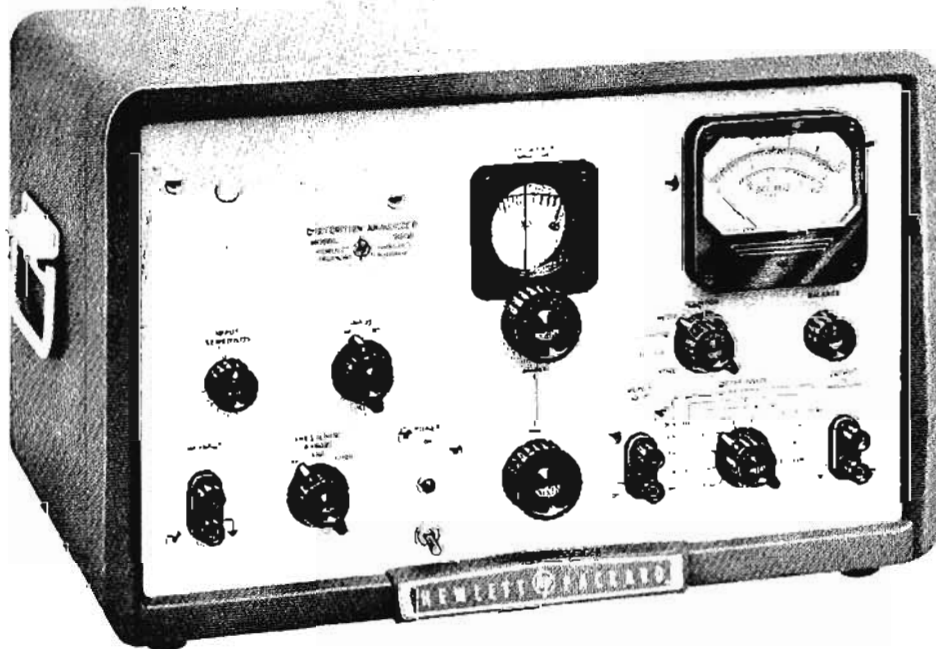

$\text{\textcircled{h}}$ 330B

to be passed at the amplifier's normal gain. (See Figure 1.) Negative feedback is employed in the amplifier to minimize distortion, to give a uniform response over a wide range of frequencies and to provide high stability. Frequency response is flat from 10 cps to 100,000 cps; thus even the 5th harmonic of 20,000 cps is passed by the amplifier without appreciable attenuation.

The voltmeter section of the equipment consists of a two-stage, high-gain amplifier, a rectifier and an indicating meter. A large amount of negative feedback is again employed to insure stability and uniform response from 10 cps to 100,000 cps. The voltmeter—which may be used as a separate instrument—responds to the average value of the applied voltage wave and is calibrated in the rms value of a sine wave.

Model 330C Distortion Analyzer

For FM broadcasters, the Φ 330C Distortion Analyzer is offered. It is identical in all respects with Φ 330B, except that the voltmeter frequency range is 10 cps to 60 KC and the indicating meter movement is provided with VU ballistic characteristics to meet F.C.C. requirements for FM Broadcasting. Like the 330B, Model 330C provides nearly infinite attenuation at any one frequency and makes possible total audio distortion measurements at any frequency from 20 to 20,000 cps.

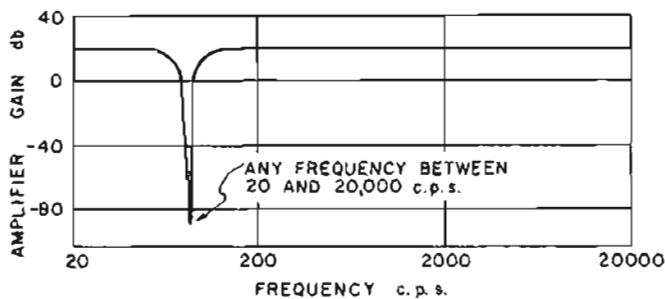

Figure 1

Model 330D Distortion Analyzer

The 330D is identical to the 330C except that an AM detector has been included. This detector permits the measurement of envelope distortion of an amplitude-modulated carrier. The detector covers a range of 500 KC to 60 MC and is varied by a tuning capacitor and range switch which selects one of five bands. (Detector may be switched out of circuit when audio frequencies are used.) Model 330D also includes the special VU meter employed in Model 330C. Other specifications are similar to Model 330B.

Specifications

Distortion Measurement Range: Any fundamental frequency, 20 cps to 20 KC.

Frequency Calibration Accuracy: $\pm 2\%$ entire range.

Elimination Characteristics: Fundamental frequency reduced by more than 99.99% (80 db). Second harmonic attenuation less than 17% (1.5 db) for fundamental frequencies 20 cps to 5 KC; less than 32% (3 db) for fundamental frequencies 5 KC to 20 KC.

Accuracy: Residual frequencies are measured to within $\pm 3\%$ of full scale value for distortion levels as low as 0.5%. Meter indication proportional to average value of residual components. Distortion introduced by instrument less than 0.1%.

Sensitivity: Distortion levels of 0.3% are measured full scale. Levels of 0.1% readable with good accuracy.

Distortion Meter Input Impedance: Approximately 200,000 ohms, 40 pf shunt.

Input Level for Distortion Measurements: At least 1 volt rms.

Voltmeter Sensitivity: Full scale sensitivities of 0.03, 0.10, 0.30, 1.00, 3.00, 10.0, 30.0, 100 and 300 volts. Nine ranges spaced exactly 10 db. Db scale: -12 db to $+2$ db, calibrated on zero level = 1 milliwatt in 600 ohms.

Voltmeter Frequency Range: Model 330B, 10 cps to 100 KC; Models 330C and 330D, 10 cps to 60 KC.

Voltmeter Accuracy: For line voltages of nominal value $\pm 10\%$ (104 volts to 126 volts), Model 330B within $\pm 3\%$, 10 cps to 100 KC; Models 330C and 330D within $\pm 3\%$, 10 cps to 20 KC and $\pm 6\%$, 10 cps to 60 KC.

Voltmeter Input Impedance: Approximately one megohm, 37 pf shunt.

Noise Measurement: Full scale reading of 300 microvolts. Noise measuring frequency range, 10 cps to 50 KC. Satisfactory readings can be made to -75 dbm.

Noise Amplifier: 40 db gain ± 1 db, 20 cps to 50 KC.

Oscilloscope Terminals: Maximum gain from AF input to oscilloscope terminals is 75 db.

Meter Movement: Models 330C and 330D: VU ballistic characteristics to meet F.C.C. requirements for AM, FM and TV broadcasting.

AM Detector: Model 330D: linear rf detector rectifies the transmitter carrier. Input circuit tunable from 500 KC to 60 MC in 5 bands. Detector distortion is negligible.

Power: 115 or 230 v $\pm 10\%$, 50 to 1,000 cps, approximately 90 watts.

Dimensions: Cabinet Mount: $20\frac{3}{4}$ " wide, $12\frac{3}{4}$ " high, $14\frac{1}{4}$ " deep. Rack Mount: 19" wide, $10\frac{1}{2}$ " high, $13\frac{3}{8}$ " deep behind panel.

Weight: Net 38 lbs. Shipping 48 lbs. (cabinet mount). Net 30 lbs. Shipping 42 lbs. (rack mount).

Accessories Available: 11000A Cable Assembly, \$4.50; 11001A Cable Assembly, \$5.50. 11005A Transformer (for bridging input), \$80.00.

Price: Φ 330B, \$500.00 (cabinet); Φ 330BR, \$485.00 (rack mount). Φ 330C, \$525.00 (cabinet); Φ 330CR, \$510.00 (rack mount). Φ 330D, \$575.00 (cabinet); Φ 330DR, \$560.00 (rack mount).

Data subject to change without notice.

VOLTAGE, CURRENT AND RESISTANCE MEASURING EQUIPMENT

Most electronic instruments for measuring the basic electrical quantities of voltage, current and resistance are extensions of the familiar d'Arsonval meter movement. These instruments use amplifiers, rectifiers and other circuits to generate a current proportional to the quantity being measured, and this current drives the meter movement. Instruments with digital readout represent a new development which will be discussed later in this article.

Some of the operating principles of Hewlett-Packard's electronic instruments for measuring E, I and R are outlined briefly here to help the user select the proper instrument for his applications.

DC Voltage Measurements

The dc voltmeter represents a straightforward application of electronics to measuring instruments. This instrument usually has a direct-coupled amplifier preceding the d'Arsonval meter movement, as shown in Fig. 1.

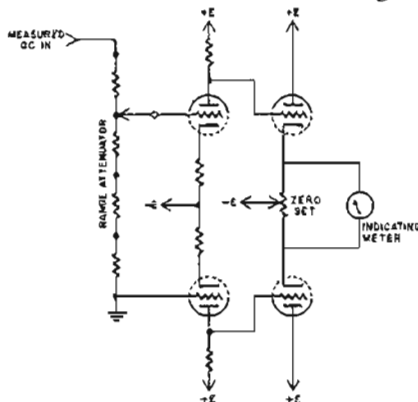

Figure 1. Basic dc voltmeter circuit.

The amplifier performs two important functions. First of all, it increases the input impedance of the meter so that the instrument draws negligible current from the circuit under test. Because of the amplifier, the electronic voltmeter is a voltage-driven device, whereas the simple d'Arsonval meter is a current-operated device. This distinction is important, since the voltages in many circuits can be altered by the current required for operating a d'Arsonval meter movement alone.

A second amplifier function is to increase the effective sensitivity of the meter movement; the amplifier changes the measured quantity into a current of sufficient magnitude to deflect the meter. An amplifier also limits the maximum current supplied to the meter movement so that there is little danger that unex-

pected overloads will burn out the meter movement.

The *hp* Model 410B is representative of this class of instruments, including dc voltage measurements among its capabilities. Input impedance is typically 100 megohms, this high an impedance having negligible loading effect on the majority of circuits being measured. The 410B uses the balanced amplifier shown in Fig. 1, minimizing the drift which is characteristic of direct-coupled amplifiers. Because of the low drift rate of this circuit, only one zero-set control is required. The measuring range of this instrument is from 1 volt full scale to 1000 volts.

DC amplifier drift, though negligible compared to the 1 v and higher ranges of the 410B, becomes comparable in magnitude to measured voltages of less than 100 mv. A widely used technique for eliminating drift in low-level measurements is to convert the dc into a comparable ac signal by alternately applying and removing the dc signal. The chopped signal is amplified in ac amplifiers and then rectified at a high level for operating the meter movement. The gain of an ac amplifier can be precisely controlled with negative feedback, and since the quantity of interest is the voltage difference between maximum and minimum excursions of the square-wave resulting from chopper action, dc drift plays no part.

The chopper technique is used in the *hp* 425A high sensitivity dc voltmeter, diagrammed in Fig. 2. The most sen-

sitive scale on this instrument reads 10 microvolts end scale (the meter face on this instrument has a center scale zero for use as a null indicator).

The important feature of the 425A is the photoconductive chopper. This converts the dc to a comparable ac by periodically shining light on photo-sensitive resistors, resulting in a low noise chopper action with high impedance and with the long life associated with semiconductors. The photo-conductive chopper also avoids the problems associated with mechanical choppers, namely, relatively short life, high replacement cost and occasionally noisy contacts. Careful attention to other sources of drift and error, such as thermocouple voltages and galvanic action, brings the drift rate of this instrument down to less than four microvolts per day.

The same technique is used in the versatile 412A volt-ohm-milliammeter which, without a zero-set control, still maintains a 1% accuracy of voltage measurements. The same circuitry is also adapted to the 413A dc null voltmeter which, like the *hp* Model 425A, has a center scale zero for use as a null detector.

DC Current Measurements

For most measurements of appreciable amounts of dc current, the d'Arsonval meter by itself serves the purpose admirably. In these cases, the meter coil requires relatively few turns to generate sufficient magnetic flux for deflecting the meter pointer. For lower current measurements, though, the sensitivity of the meter movement must be increased, usually by using more turns in the coil. These added turns increase the resistance of the current path, which can be troublesome in low impedance circuits.

Electronic instruments overcome this difficulty by measuring the small voltage drop across a low-value resistance placed in series with the current to be

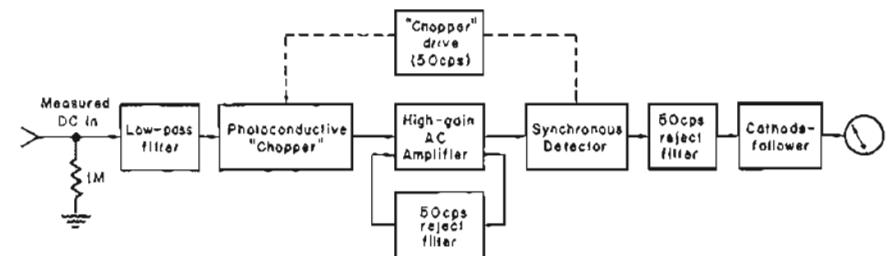

Figure 2. Block diagram of *hp* 425A Microvoltmeter. Choice of 50 cps for chopper frequency avoids beat effects with 60 cps hum.

measured. The *hp* 412A and 425A voltmeters are equipped with internal calibrated shunt resistors for reading dc currents in this way without accessory equipment. These instruments cover the range from 10^{-11} amperes to 1 ampere full scale (412A 10^{-6} to 1 amp full scale; 425A, 10^{-11} to 3 ma full scale). The sensitivity of the 412A instruments is such that the $1 \mu\text{a}$ scale adds only 1000 ohms to the circuit, while the 10 ma and higher scales add only 0.1 ohms.

measured. The *hp* 412A and 425A voltmeters are equipped with internal calibrated shunt resistors for reading dc currents in this way without accessory equipment. These instruments cover the range from 10^{-11} amperes to 1 ampere full scale (412A 10^{-6} to 1 amp full scale; 425A, 10^{-11} to 3 ma full scale). The sensitivity of the 412A instruments is such that the $1 \mu\text{a}$ scale adds only 1000 ohms to the circuit, while the 10 ma and higher scales add only 0.1 ohms.

Current measurements using a series resistor have the obvious disadvantage of interrupting the circuit under test with the resistor. In many applications, insertion of a resistance in the line of current flow may alter the current being measured or even alter the circuit operation. To overcome this difficulty, a new class of ammeters has been developed at Hewlett-Packard. These instruments, designated the 428A and 428B DC Milliammeters, use a current probe which simply clips around the current-carrying wire without disturbing the circuit.

These probes use the second-harmonic flux gate principle to sense the magnetic flux around the wire. The probe encircles the wire with a magnetic core which is saturated periodically by a 20 kc driving current. Saturation interrupts the magnetic circuit, thus effectively "gating" any flux induced in the core by current in the wire. This gated ac flux couples to sensing coils on the core, inducing a 40 kc voltage that is proportional to the current in the wire. The instrument's circuitry amplifies the coil voltage and drives the indicating meter accordingly. High linearity is achieved by use of a negative feedback dc current, balancing input ampere turns against feedback ampere turns.

These instruments enable current measurements to be made as easily as voltage measurements, requiring no alteration of the circuit under test. The probe adds a negligible amount of inductance (0.5 microhenry) to the cir-

variety of other uses are found, such as measuring the current in ground loops where the impedance is too low for the series-resistance technique to be applied.

A unique feature of these probes is that the sums and differences of currents in several wires can be determined by running the wires through the probe at the same time, irrespective of the voltages on the wires. This technique is useful for balancing push-pull amplifier stages, by running the two plate leads in opposite directions through the probe and then adjusting for a null on the current meter.

Resistance Measurements

Resistance is usually determined through the familiar ohm's relation: $E=IR$. Traditionally, this is done by applying a known voltage E to the unknown resistance R and then measuring the current I passing through it. With E and I known, R can be computed.

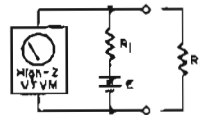

Figure 4. Resistance measurement with an electronic voltmeter.

A modified procedure for doing this with electronic voltmeters is shown in Fig. 4. Here, the current flowing in the circuit depends on the series combination of the unknown resistor R_x and the internal resistor R_1 . This means, of course, that both the voltage and current

range then occurs when R_x equals R_1 .

The resistance R_1 , included as part of the ohmmeter, provides a convenient means of changing the range of the instrument. The 410B has mid-scale resistance readings ranging from 10 ohms to 10 megohms in seven ranges.

When values of low resistance are being measured, the finite resistance of the ohmmeter leads, being included in the total resistance measurement, can contribute considerable error. To meet this problem, a more refined circuit is used, as shown in Fig. 5. The resistance

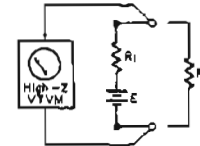

Figure 5. Measurement of low value resistances.

of the current-carrying leads is calibrated as part of R_1 while the resistance in the voltmeter leads is insignificant compared to the high input impedance of the metering circuit. This arrangement, using four leads, is found in the *hp* Model 412A.

To measure extremely low resistances, such as found in short lengths of large wire or in relay contacts, a different combination of instruments is recommended. A constant current source, such as the *hp* 726AR 2-Ampere Power Supply, is used to supply a fixed amount of current through the unknown resistance. A sensitive voltmeter (*hp* 425A, for example) then is used to measure the voltage drop across the resistance being measured. With this combination, resistance measurements as low as 1 micro-ohm may be made.

High resistance measurements, on the other hand, can be disturbed by the impedance of the measuring voltmeter when this impedance is comparable to the resistance being measured. The 412A accounts for this by adjusting the values of R_1 on the high resistance ranges to compensate for the voltmeter input impedance. On the 100 megohm scale, for example, R_1 is actually 200 megohms. The parallel combination of the 200 megohm R_1 and the 200 megohm input impedance of the meter gives an effective internal impedance of 100 megohms.

Extremely high resistances, as in the case of extremely low resistances, are measured by a combination of instruments. For high resistances, a high voltage is applied to the unknown and the current flow is measured on a sensitive instrument. For instance, the most sen-

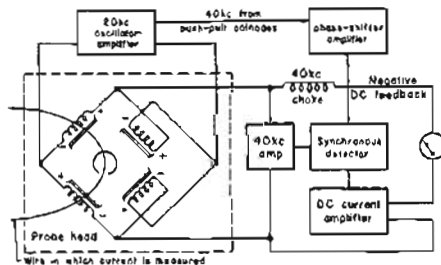

Figure 3. Simplified block diagram of clip-on milliammeter. Plus and minus signs indicate polarities of voltages induced by gated flux, which is proportional to current in wire. Bridge is balanced for 20 kc driving signal but is not balanced for induced 40 kc signal.

cuit being measured and less than 15 mv of the 20 kc driving voltage is coupled into the measured circuit. Sensitivity can be increased by looping the measured wire through the probe two or more times.

The clip-on probes are finding wide use in transistor circuit measurements where current flow has to be monitored more carefully; sensitivity is such that even base current can be measured. A

in the external circuit will change according to the value of the unknown. Instruments which include the ohmmeter functions, such as the *hp* 410B and 412A, have meter scales calibrated to account for this. If R_x were infinite, the meter would read the full battery voltage E ; full scale deflection therefore corresponds to a resistance of infinity. If R_x were zero (short circuit) the meter reads zero. The mid-scale

sitive current range of the 425A, used with a 500-volt supply, such as the *hp* 711A, can measure resistances as high as 5×10^{14} ohms.

AC Voltage Measurements

Electronic instruments for measuring ac voltages also use an amplifier with the d'Arsonval meter movement but add a rectifier circuit to convert the ac to dc. Meter-indicating ac voltmeters built by *hp* fall into three broad categories: average-responding, peak-responding and rms-responding meters.

The circuit principle of the average-reading meter is shown in Fig. 6. Here, the ac signal is amplified in a gain-stabilized ac amplifier and then is rectified by the diodes. The resulting current



Figure 6. Average-responding voltmeter.

pulses, smoothed by the mechanical inertia of the meter, drive the meter. The meter deflection is proportional to the average value of the waveform being measured.

The peak-responding voltmeter, shown diagrammatically in Fig. 7, places

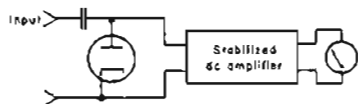

Figure 7. Peak-responding voltmeter.

the rectifier in the input circuit where it charges the small input capacitor to the peak value of the input signal. This voltage is passed to a dc amplifier, which drives the meter. Meter deflection here is proportional to the peak amplitude of the input waveform.

Both of these meters (average-responding and peak-responding) have scales calibrated such that the rms value of a sine wave input voltage is indicated, since the meters are used primarily for sine wave measurements. The average-responding type therefore reads 1.11 times higher than the average voltage, while the peak-responding type indicates 0.707 of the peak voltage. Consequently, both meters may be in error if the measured signal is not a pure sine wave. Table 1 indicates the magnitude of error which can occur with these meters; the amplitude and phase of the harmonics present affect the peak and average values of the waveform, upsetting the rms calibration. As

% Harmonic	True Rms Value	Model 400D Indication	Peak Meter Indication
0	100	100	100
10% 2nd	100.5	100	90 to 110
20% 2nd	102	100 - 102	80 to 120
50% 2nd	112	100 - 110	75 to 150
10% 3rd	100.5	96 - 104	90 to 110
20% 3rd	102	94 - 108	88 to 120
50% 3rd	112	90 - 116	108 to 150

Table 1. Measurement errors from harmonic or other spurious voltages.

the table shows, the average-reading voltmeter is not affected by distortion as much as the peak-reading type is. If highly complex waveforms are to be measured, then a true rms-responding voltmeter is recommended.

The widely used *hp* series 400 vacuum tube voltmeters are average-responding meters using these principles. The 400D represents a low priced precision voltmeter offering voltage ranges from 1 mv to 300 v full scale, 2% accuracy and a frequency coverage from 10 cps to 4 mc. The 400H is similar but offers 1% accuracy and has a custom-calibrated, 5 inch, mirror-backed scale.

The 400L also has the same circuitry and a 5 inch mirror scale, but in this case the meter movement is logarithmic. The 400L scale is evenly divided into db units for the convenience of acoustical and communications engineers. The portable, transistorized, battery operated 403A and 403B are likewise average-responding meters. The peak-responding meters are used for higher frequency measurements because of their lower input capacitance. The capacitance to ground of the input circuit and probe of a voltmeter must be included as part of the input impedance. This capacitance acts as a high frequency bypass to the input resistance and limits the frequency range of most ac voltmeters.

Since the diode rectifier of peak-responding voltmeters is placed in the probe tip preceding the amplifier, shortening the signal path, the ac capacitance is low. Input capacitances of one to three picofarads are characteristic of these instruments. The *hp* 410B general purpose vacuum tube voltmeter uses a special probe for high frequency ac measurements and employs a diode expressly designed for Hewlett-Packard. Input impedance of this instrument is 10 megohms resistive, shunted by only 1.5 pf capacitance. The frequency range of this instrument is from 20 cycles per second to more than 700 megacycles.

The extension of this technique into the millivolt range is impractical because of the non-linear response of di-

odes at low signal levels. A variation of the rectifying technique is required to eliminate the diode non-linearity. The 411A RF Millivoltmeter does this by using two diodes, as shown in Fig.

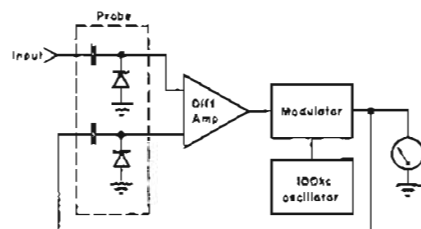

Figure 8. RF millivoltmeter.

ode, one of which rectifies the ac signal in the usual manner. The second diode is fed an internally generated 100 kc signal. The resulting dc from the signal diode is fed to one input of a differential amplifier and the rectified 100 kc is fed to the other input. The voltage difference between the diode outputs is amplified and is used to control the amplitude of the internal 100 kc signal accordingly. This arrangement is, in effect, a feedback control system which matches the amplitude of the 100 kc signal at the second diode to the amplitude of the input rf signal. The 100 kc signal then is proportional to the input signal so that a simple meter circuit, reading this amplitude, indicates the input voltage, while preserving the linear voltage scales. The most sensitive scale on this instrument is 10 millivolts over a range of 500 kc to 1000 mc.

As mentioned previously, complex waveforms are measured most accurately by an rms-responding voltmeter. Mathematically speaking, the root-mean-square (rms) value of any complex quantity is obtained by summing the squares of each component and then taking the square root of this sum:

$$E_{\text{rms}} = \sqrt{E_1^2 + E_2^2 + E_3^2 + \dots}$$

This operation is performed by sensing the waveform's heating power, which is proportional to $(E_{\text{rms}})^2$. The indicating circuitry responds to the square root of the heating power. Heating power commonly is measured by feeding an amplified version of an input waveform to the heater of a thermocouple, the voltage output of the thermocouple being proportional to the waveform's heating power.

In the past, the primary difficulty with this technique has been the non-linear behavior of the thermocouple which complicates the calibration of the indicating meter. The new *hp* 3400A RMS Voltmeter overcomes this difficulty by the use of two thermocouples mounted in the same thermal environment. Non-linear effects in the measur-

ing thermocouple then are cancelled by similar non-linear operation of the second thermocouple.

As shown in the block diagram of Fig. 9, the amplified input signal is applied to the measuring thermocouple and a dc feedback voltage is fed to the

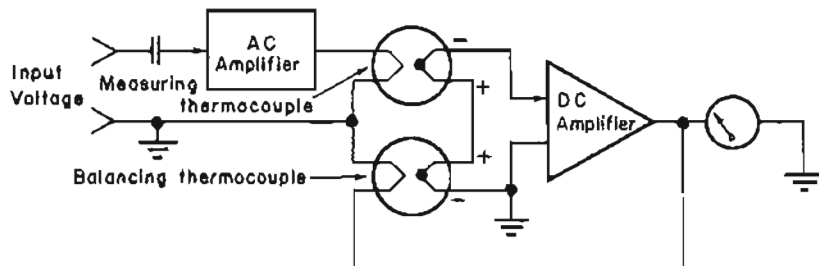

Figure 9. RMS responding voltmeter.

balancing thermocouple. The dc voltage is derived from the voltage output difference between the thermocouples. Here, again, the circuitry may be looked upon as a feedback control system which matches the heating power of the dc feedback voltage to the input waveform's heating power. Meter deflection is proportional to the feedback dc, which in turn is equivalent to the input signal. The meter indication, therefore, is linear.

This arrangement allows the Model 3400A to provide highly accurate readings of the rms value of complex waveforms. Full scale accuracy is maintained with waveforms having crest factors (ratio of peak-to-rms) as high as 8:1. At 10% of full scale deflection, where there is less likelihood of amplifier clipping, waveforms with crest factors as high as 80:1 are accommodated.

The 3400A reads voltages throughout a range of 100 μ v to 300 v rms within a frequency range of 10 cps to 8 mc.

AC Current Measurements

AC current measurements can be made by the use of a sensitive ac voltmeter and a series resistance, as described in dc current measurements. Hewlett-Packard manufactures calibrated shunt resistors for this purpose. These are designed for use with the 400 series meters, making these instruments direct reading in current units.

The *hp* 456A Current Probe, though, enables ac current to be measured without disturbing the circuit. This probe clips around the wire carrying the current to be measured and, in effect, makes the wire the 1-turn primary of a transformer formed by ferrite cores and a many-turn secondary within the probe. The signal induced in the secondary is amplified in a battery operated transistor amplifier and the ampli-

fier's voltage output can be applied to any suitable ac voltmeter for measurement. The amplifier constants were chosen so that 1 ma in the wire being measured produces 1 mv at the amplifier output. Current therefore is read directly on the voltmeter.

Digital Instruments

Electronic measuring instruments with digital readout do not use the d'Arsonval meter movement but display the reading as discrete numerals. More complicated circuitry is required in these instruments but several benefits are obtained. For one, digital instruments are well suited for production line work, since the readings are given in numbers which may be written down directly. Many of these instruments also

Digital instruments are not useful, though, as indicators of peak or null values during adjustments on equipment; the familiar meter movement such as on the *hp* 413 Null Voltmeter, provides a more easily interpreted indication. Similarly, digital readout is not as readily adapted to measurements or adjustments within a given tolerance; limits marked on a meter face are better suited for this.

The *hp* 405B and 405C Digital Voltmeters were designed to provide the convenience of digital measurements at a reasonable price. These instruments use the ramp comparison technique, which operates as follows (Fig. 10): At the instant the ramp (single cycle sawtooth) begins, the gate opens and decade counters start totalizing the internally generated clock pulses. The ramp voltage is compared continuously to the input dc voltage and at the instant that they are equal, the circuitry closes the gate while the readout holds and indicates the number of clock pulses counted. The measurement cycle repeats at regularly recurring intervals. By suitable choice of ramp slope and clock rate, one thousand counts equals a 1 volt input. Since the ramp is linear,

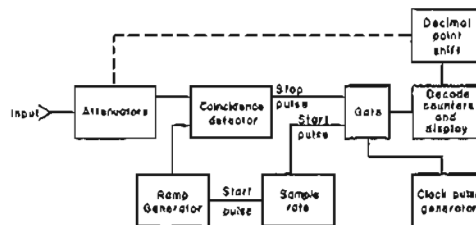

Figure 10. Simplified block diagram of 405B,C Digital Voltmeters. Decode counter overflow triggers decimal point shifter to set attenuator to higher range. No-count in hundreds counter triggers shift to lower range. On negative voltages ramp polarity is inverted.

are automatic range seeking, which means that unskilled personnel may use them without the necessity for interpreting the range setting or interpolating a meter's scale division. A secondary benefit of digital instruments is that the digital technique provides outputs for operating automatic printers or punched card or punched tape mechanisms.

Digital instruments also are capable of extremely high accuracy since digital readouts can provide readings to four or five places. d'Arsonval movements, on the other hand, can only be estimated to three-place accuracy.

Digital instruments are useful for detecting small increments in relatively large voltages. A change of 1 mv in a 1 volt signal is quite apparent on the *hp* 405 type voltmeters but such a change would be extremely difficult to detect on a meter face.

the accumulated count always directly indicates the input voltage. If the input voltage exceeds 1 volt, the instrument automatically selects a higher range, shifts the decimal point in the readout display accordingly, and makes a new measurement.

The digital technique can be extended to ac measurements by use of a suitable ac-to-dc converter, such as the *hp* 457A. Digital instruments are also manufactured by the *hp* Dymec Division (see page 103).

Resistance measurements with digital voltmeters are performed with an auxiliary power supply as described in the section on resistance measurements. Current measurements, likewise, may be performed with a digital voltmeter by the use of a series resistor in the current path or with the output of the 428B Clip-on DC Milliammeter connected to the voltmeter.

hp 400D, 400H, 400L VACUUM TUBE VOLTMETERS

Highest Quality, Highest Accuracy Linear and Log Voltmeters

Advantages:

- Exceptional long-term stability
- Large voltage range. High sensitivity
- Broad 10 cps to 4 MC frequency coverage
- 400H custom calibrated to eliminate tracking error
- High 10 megohm input impedance
- Premium quality throughout; easy to service
- Usable as a stable, high gain amplifier
- Large overvoltage capacity

Uses:

- Research and Development Laboratory
- Production Test
- Communications
- Service Departments

On these pages Hewlett-Packard presents three of the industry's most widely used vacuum tube voltmeters.

Basically similar instruments, Models 400D, 400H and 400L have specific characteristics which render them suited to given applications.

Model 400D is essentially a low-priced precision voltmeter offering wide voltage range, 2% accuracy and the broad frequency coverage 10 cps to 4 MC.

Model 400H is an adaptation of Model 400D but offering individual meter face calibration and the extreme accuracy of 1% on an extra large 5" mirror-scale meter.

Model 400L, a logarithmic version of Model 400D, has an accuracy of $\pm 2\%$ of reading or $\pm 1\%$ of full scale, whichever is more accurate. The 5" meter is mirror-backed.

Custom Calibration

As indicated above, Model 400H is custom calibrated to eliminate tracking error. Scale tracking error is one of the major and inherent causes of inaccuracy in a voltmeter, but this has been eliminated, on a production basis and at no extra cost to the buyer, in this precision hp instrument. The re-



hp 400D

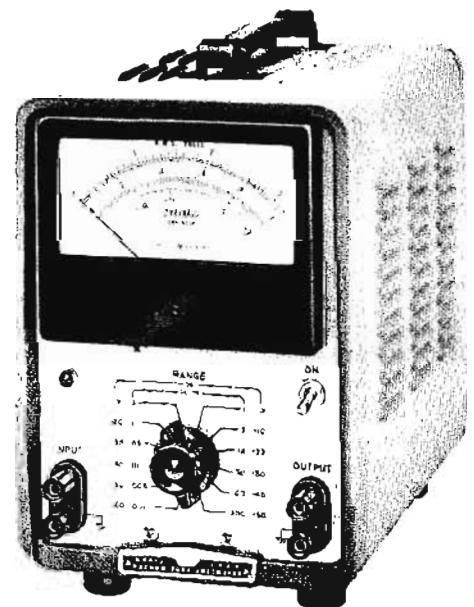

hp 400H

sult is maximum accuracy for the indicating meter itself, and maximum accuracy for the instrument itself — the combination of the meter and its driving circuitry.

General Description

Models 400D,H, and L are deliberately engineered to give you the best possible combination of measuring accuracy, frequency and voltage range, and the trouble-free service life you expect from Φ ; in short, perhaps the best multi-purpose voltmeters available.

An important feature of each is the Φ -developed amplifier providing approximately 60 db of feedback at mid-range. This assures highest stability and freedom from calibration change due to external conditions.

Stability long term is such that a reduction in the G_m of the amplifier tubes to 75% of nominal value causes an error of less than 0.5%, 50 cps to 1 MC.

And even line voltage variations as high as $\pm 10\%$ cause negligible change.

Other features common to these three rugged Φ voltmeters include a high 10 megohm input impedance preventing loading to circuits under test, generous overload protection guarding the instruments even against peaks of 600 volts, special circuitry minimizing transients during switching, premium quality construction throughout, and output circuitry permitting the voltmeters to be used as broadband, high gain amplifiers throughout their full frequency range.

1% Accuracy Model 400H

As indicated above, Model 400H is similar to Model 400D but offers 1% accuracy. Details of accuracy at various frequencies are found in the table below.

Logarithmic Model 400L

Designed specifically for acoustical and communications engineers, and men working with decibel measurements, Model 400L incorporates a special logarithmic meter movement. The log voltage scale plus unusually long scale length provide an instrument of maximum readability and accuracy which is a *constant percentage* ($\pm 2\%$) of reading. The decibel scale is more than 5" long, and voltage scales spread across the full scale length. The meter is mirror-backed for utmost accuracy. A range switch changes voltage sensitivity in 10 db levels. This feature, together with the 12 db scale, provides the wide overlap desirable in decibel level measurements.

Special DB-Measuring 400D and 400H

As normally supplied, Models 400D and 400H read direct in volts and db, with the voltage scale uppermost. For greater resolution in db measuring, these instruments are available as Models 400D-db and 400H-db (\$25.00 extra) with the db meter scale uppermost.

Accessories

See page 111 for line matching and bridging transformers. Capacitive voltage dividers and other useful accessories for Φ vacuum tube voltmeters are listed on page 109. A voltmeter calibration system is described on page 110. The 456A AC Current Probe is described on page 108.

Data subject to change without notice.

Specifications

	400D,DR	400H,HR	400L,LR
Voltage Range:	1.0 mv to 300 v full scale, 12 ranges		
Frequency Range:	10 cps to 4 MC		
Accuracy: (as % of full scale on 400 D/DR, 400 H/HR)	$\pm 2\%$, 20 cps to 1 MC; $\pm 3\%$, 20 cps to 2 MC; $\pm 5\%$, 10 cps to 4 MC	$\pm 1\%$, 50 cps to 500 KC; $\pm 2\%$, 20 cps to 1 MC; $\pm 3\%$, 20 cps to 2 MC; $\pm 5\%$, 10 cps to 4 MC	$\pm 2\%$ of reading or $\pm 1\%$ of full scale whichever is more accurate, 50 cps to 500 KC. $\pm 3\%$ of reading or $\pm 2\%$ of full scale, 20 cps to 1 MC; $\pm 4\%$ of reading or $\pm 3\%$ of full scale, 20 cps to 2 MC; $\pm 5\%$ of reading, 10 cps to 4 MC
Long Term Stability:	Reduction in G_m of amplifier tubes to 75% of nominal value results in error of less than 0.5%, 50 cps to 1 MC		
Calibration:	Reads rms value of sine wave. Voltage indication proportional to average value of applied wave. Linear voltage scales 0 to 3 and 0 to 1; db scale —12 to +2 db, 0 db = 1 mw in 600 ohms. 10 db interval between ranges.		Reads rms value of sine wave. Logarithmic voltage scales 0.3 to 1 and 0.8 to 3. Linear db scale, —10 db to +2 db, based on 0 db = 1 mw in 600 ohms, 10 db intervals between ranges.
Input Impedance:	10 megohms shunted by 15 pf on ranges 1 to 300 v; 25 pf on ranges 0.001 to 0.3 v		
Amplifier:	Output approx. 0.15 v max. Internal impedance 50 ohms. Max. gain approx. 150 on 0.001 range.		
Power:	115 or 230 volts $\pm 10\%$, 50 to 1,000 cps, approx. 80 watts (100 watts for 400 H/L)		
Dimensions:	Cabinet Mount: 7 1/2" wide, 11 1/2" high, 12" deep. Rack Mount: 19" wide, 7" high, 10 3/4" deep behind panel.		
Weight:	Net 18 lbs. Shipping 23 lbs. (cabinet mount). Net 21 lbs. Shipping 30 lbs. (rack mount)		
Price:	-hp- 400D \$250.00* -hp- 400DR \$255.00**	-hp- 400H \$325.00* -hp- 400HR \$330.00**	-hp- 400L \$325.00* -hp- 400LR \$330.00**

* Cabinet ** Rack Mount



Φ 400L

3400A RMS VOLTMETER

Measure True Root-Mean-Square Voltage

Advantages:

- High crest factor acceptance for accurate pulse measurement
- Linear scale for high resolution
- DC output proportional to meter deflection
- Wide bandwidth
- High sensitivity
- High input impedance
- No zero control; simple operation

Uses:

- Measure level of noise with a crest factor of 80
- Measure rms value of pulse trains
- Measure true rms current using *hp* 456A Current Probe
- Make frequency response tests
- Use as ac-to-dc converter for recorder or digital voltmeter operation

Hewlett-Packard Model 3400A RMS Voltmeter is a rugged instrument that measures the actual root-mean-square value of ac voltages between 100 μ v and 300 v rms and in the frequency range 10 cps to 8 mc. These voltages may be sinusoidal or nonsinusoidal and have crest factors (ratio of peak to rms) as high as 8 at full scale deflection and as high as 80 at 10% of full scale deflection. The ability of the 3400A to accept waveforms having such large crest factors insures that measurements will be accurate, even when measuring nonsinusoidal waveforms such as noise and pulse trains, without the need for correction factors.

Model 3400A is extremely simple to operate because it requires no zero-set control and voltages are read from a linear voltage scale or in db. The voltmeter's 10 megohm input resistance minimizes circuit loading.

Versatility

The *hp* 3400A supplies a dc voltage from a rear panel connector that is proportional to the rms value of the input signal. Because of the high stability and linearity of this dc signal, you may use it to drive accessory equipment such as strip chart recorders for permanent records or digital voltmeters for high resolution measurements.

You also can measure the rms value of an ac current merely by using the *hp* Model 456A Current Probe. The jaws of the 456A, which sample the magnetic field about a conductor, are simply clamped around the conductor without breaking the circuit and do not disturb the measured circuit. Model 456A produces a 1-mv output for a 1-ma input; consequently

the 3400A's scales may be read directly without scale conversion.

Feedback Technique

The key element of the 3400A is a self-balancing feedback circuit in which the rms value (heating effect) of the input signal is nulled with the rms value of a dc signal developed by a chopper amplifier. The input signal, after passing through the high impedance input attenuator and a high gain ac amplifier, is applied to the heater of one thermocouple. Output from this "ac" thermocouple is amplified in the chopper amplifier and fed back to another thermocouple whose output is subtracted from (nulled with) that of the ac thermocouple. Hence, the input to the chopper amplifier is the difference in output between the two thermocouples, and the chopper amplifier's output voltage is proportional to the rms value of the ac input signal. Such a feedback technique and quick-acting thermocouples result in a voltmeter that responds rapidly to a change in input signal, and driving the meter from the feedback voltage provides linear voltage scales that are much easier to read than scales derived for square-law detectors. In addition, so that you can make most measurements in the more accurate upper two-thirds of the scale, two scales are provided. One scale is calibrated from 0 to 1, the other from 0 to 3. The meter scale has a mirror back for precise readings.

Custom-Calibrated Meter

Each meter face is custom calibrated in a Hewlett-Packard developed servo system which prints the meter scales to the specific meter movement used in each *hp* 3400A. Not only does this individual calibration of the meter movement virtually eliminate tracking error, but the servo system also rejects marginal meter movements by indicating the magnitude of pivot friction in a hysteresis plot of current versus pointer position.

Each of the 12 full-scale ranges is quickly and easily selected by a front-panel switch that changes attenuation in accurate 10-db steps. The 10-db range steps enable you to use the upper two-thirds of the meter scale for greater accuracy and make possible a convenient meter scale for measurements in db and dbm. This scale, calibrated from -12 to $+2$ db, permits measurements from -72 to $+52$ dbm (0 dbm = 1 mw in 600 ohms). Furthermore, the unique circuitry of the 3400A protects the thermocouples from overloads and eliminates the need for front-panel zero and calibration adjustments.

Tentative Specifications

Range: 100 μ v to 300 v rms, 12 full scale ranges from 1 mv to 300 v in a 1, 3, 10 sequence. — 72 to + 52 dbm (0 dbm = 1 mw into 600 ohms).

Meter Scales: Voltage, 0 to 1 and 0 to 3. Decibel, — 12 to + 2 db. Scales are individually calibrated to the meter movement.

Frequency Range: 10 cps to 8 mc.

Accuracy: Within $\pm 1\%$ of full scale, 50 cps to 3 mc. Within $\pm 5\%$ of full scale, from 10 to 50 cps and from 3 to 8 mc.

Response: Responds to rms value (heating value) of the input signal for all waveforms.

Response Time: Typically less than 2 sec to reach 99% of final value.

Crest Factor (ratio of peak amplitude to rms amplitude): 8 to 1 at full scale, inversely proportional to pointer deflection, e.g., 16 to 1 at half-scale, 80 to 1 at tenth-scale.

Maximum Input: Input capacitor rated at 600 v dc.

Input Impedance: 10 megohms shunted by 25 pf.

Output: 1 v dc at full scale deflection, proportional to pointer deflection. 1 ma maximum. Nominal source impedance is 1000 ohms.

Power: 115 or 230 v $\pm 10\%$, 50 to 60 cps, approximately 7 watts.

Dimensions: 5 $\frac{1}{8}$ " wide, 6 $\frac{1}{2}$ " high, 11" deep.

Weight: Net 7 $\frac{1}{4}$ lbs. Shipping 11 lbs.

Accessory Furnished: 10110A Adapter, BNC to dual banana jack.

Accessories Available: *bp* 10503A Cable 4' long, male BNC connectors, \$6.50. *bp* 11001A Cable 45" long, male BNC to dual banana plug, \$5.50. *bp* 11002A Test Lead, dual banana plug to alligator clips, \$7.50. 11003A Test Leads, dual banana plug to probe and alligator clip, \$10. *bp* 456A AC Current Probe, 1 mv/ma, \$190.

Price: \$525.

Data subject to change without notice.

AVAILABLE
FALL 1963

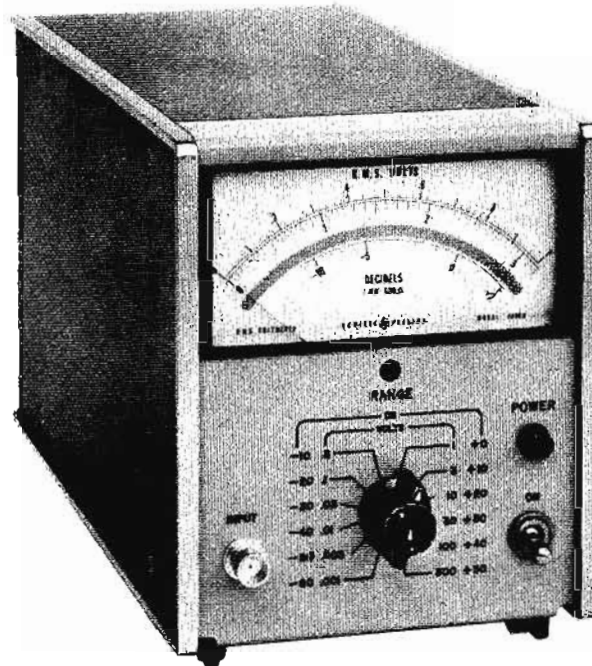

hp 403A,B TRANSISTORIZED AC VOLTMETERS

**Compact, Battery-Operated,
Portable**

Model 403A and 403B AC Voltmeters are versatile general-purpose instruments for laboratory and production work and are ideal for use in the field, since they are transistorized, battery-operated and portable.

Both measure from 100 microvolts to 300 volts, the 403A covering 1 cps to 1 mc and the 403B covering 5 cps to 2 mc. Both operate from internal batteries and thus may be completely isolated from the power line and external grounds, permitting accurate measurements at power line frequency and its harmonics without concern for beat effects. Isolation from external ground also permits use where ground loops are troublesome. Turnover effect and waveform errors are minimized because the meters respond to the average value of the input signal.

The 403B operates from an ac line, as well as from the internal battery pack, and batteries recharge during ac operation. A sturdy taut-band meter eliminates friction and provides greater precision and repeatability. Also, since taut-band meters are inherently less subject to damage from shock and vibration than jewelled D'Arsonval movements, the 403B withstands the rough handling often encountered in field use. This model is also available with the decibel scale uppermost on the meter face.

Data subject to change without notice.

Specifications

	403A	403B
Range:	0.001 to 300 v rms full scale, 12 ranges.	
Meter:	Respond to average value of input waveform and are calibrated in the rms value of a sine wave.	
Frequency Range:	1 cps to 1 mc.	5 cps to 2 mc.
Accuracy:	Within $\pm 3\%$ of full scale, 5 cps to 500 kc. Within $\pm 5\%$ of full scale, 1 to 5 cps and 500 kc to 1 mc.	Within $\pm 2\%$ of full scale from 10 cps to 1 mc. Within $\pm 5\%$ of full scale from 5 to 10 cps and 1 to 2 mc, except $\pm 10\%$ 1 to 2 mc on the 300 v range. (0 to 50°C.)
Nominal Input Impedance:	2 megohms shunted by approx. 40 pf, 0.001 to 0.1 v ranges; 20 pf, 0.3 to 10 v ranges; 15 pf, 30 to 300 v ranges.	2 megohms shunted by approx. 50 pf, 0.001 to 0.03 v ranges; 25 pf, 0.1 to 300 v ranges.
Maximum Input:	600 v peak, 0.3 v and higher ranges; 25 v rms on 0.1 v and lower ranges.	600 v peak, 0.3 to 300 v range; 25 v rms, 60 v peak, 0.001 to 0.1 v ranges.
Power Supply:	5 standard radio type mercury cells, battery life approx. 400 hours.	4 rechargeable batteries, 40 hours' operation per recharge, up to 500 recharging cycles. Self-contained recharging circuit functions during operation from ac line.
Dimensions:	8 1/4" wide, 5 1/2" high, 6 3/8" deep.	5 3/8" wide, 6-3/32" high, 8" deep.
Weight:	Net 4 3/4 lbs. Shipping 9 lbs.	Net 6 1/2 lbs. Shipping 10 lbs.
Price: (Batteries Furnished)	\$275	\$310 (403B-DB, decibel scale uppermost, \$333).

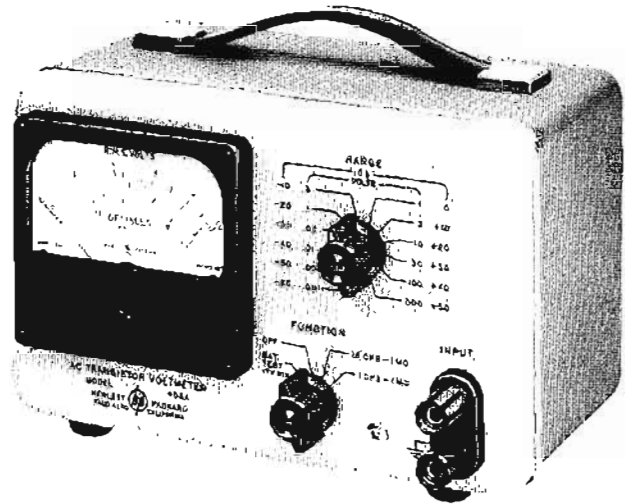

403A

NEW IN THIS CATALOG

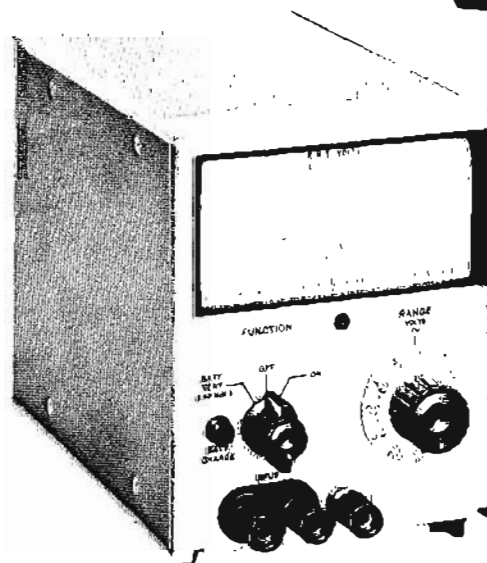

403B

hp 3550A PORTABLE TEST SET

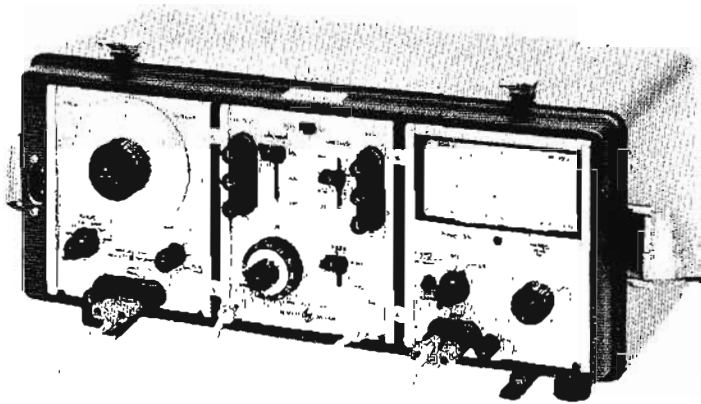

NEW IN THIS
CATALOG

Convenient Tool for
Measuring Transmission Line,
System Characteristics

This new portable test set is designed specifically to measure transmission line and system characteristics such as attenuation, frequency response or gain, and it is particularly useful for lineup and maintenance of multichannel communication systems.

It consists of a wide range oscillator, a voltmeter, an attenuator and impedance matching networks that are mounted in a combining case equipped with a splash-proof cover. The oscillator, voltmeter and attenuator with its impedance matching transformers, may be used separately, in or out of the combining case. The hp 353A is particularly useful with the 400 series voltmeters to match 135-, 600- or 900-ohm lines.

Versatile Components

The oscillator has a frequency range of 5 cps to 560 kc, and its output is fully floating isolated from instrument case and power-line. (see page 70).

The voltmeter (see 403B, page 92) features a sensitive range, 1 mv full scale, for measuring voltages as small as 100 μ v rms from 5 cps to 2 mc. A db scale, which is at the top of the meter face for better resolution, also permits measurement from - 75 to + 52 dbm.

The patch panel portion of the test set includes a precision attenuator, variable in 1 db steps to 110 db and two sets of impedance matching transformers which match both oscillator and voltmeter to 135-, 600- and 900-ohm lines. One set of transformers also terminates the line in 10K ohms for bridging measurements.

Both oscillator and voltmeter are solid state and operate from their own internal rechargeable batteries or from the ac line. The batteries provide 40 hours of operation between charges and are recharged automatically during operation from the ac line.

Specifications

Oscillator (H07-204B)

Frequency Range: 5 cps to 560 kc in 5 ranges; vernier.
Dial Accuracy: \pm 3%.
Frequency Response: \pm 3% into rated load.
Output Impedance: 600 ohms.
Output: 10 mw (2.5 v rms) into 600 ohms; 5 v rms open circuit.
Completely floating (isolated).
Distortion: Less than 1%.
Hum and Noise: Less than 0.05%.
Temperature Range: -20°C to + 50°C.
Price: \$390 when purchased separately.

Voltmeter (403B-DB)

Range: 0.001 to 300 volts rms full scale (12 ranges) in a 1, 3, 10 sequence; - 75 dbm to + 52 dbm. Decibel scale uppermost; calibrated in 0.2 db increments.
Frequency Range: 5 cps to 2 mc.
Accuracy: Within \pm 2% of full scale from 10 cps to 1 mc, within \pm 5% of full scale from 5 to 10 cps and 1 to 2 mc, except \pm 10%, 1 to 2 mc on the 300 v range (0 to 50°C).
Nominal Input Impedance: 2 megohms; shunted by approx. 50 pf on 0.001 v to 0.03 v ranges, 25 pf on 0.1 v to 300 v ranges.
DC Isolation: Signal ground may be \pm 500 v dc from external case.
Price: \$335 when purchased separately.

Patch Panel (353A)

Input (Receiver):
Frequency Range: 50 cps to 560 kc.
Balance: Better than 40 db.
Frequency Response: \pm 1/2 db, 50 cps to 560 kc.
Impedance: 135, 600, 900 ohms and Bridging (10K); center tapped.
Insertion Loss: Less than 3/4 db at 1 kc.
Maximum Level: + 10 dbm (2.5 v rms at 600 ohms).
Output (Source):
Frequency Range: 50 cps to 560 kc.
Balance: Better than 40 db.
Frequency Response: \pm 1/2 db, 50 cps to 560 kc.
Impedance: 135, 600, and 900 ohms center tapped.
Insertion Loss: Less than 3/4 db at 1 kc.
Distortion: Less than 1%, 50 cps to 560 kc.
Maximum Level: + 10 dbm (2.5 v rms at 600 ohms).
Attenuation: 110 db in 1 db steps. Accuracy, 10 db section: Error is less than \pm 0.25 db at any step. Accuracy, 100 db section: Error is less than \pm 0.5 db.
Connectors:
Two 3-terminal binding posts for external circuit connection and two BNC female connectors for oscillator and voltmeter connection.
Price: \$230 when purchased separately.

General

Power Supply: (Identical specifications in both voltmeter and oscillator): 4 rechargeable batteries (furnished). 40 hour operation per recharge, up to 500 recharging cycles. Recharging circuit is self-contained and functions automatically when instrument is operated from ac line (115 or 230 v \pm 10%, 50 to 1000 cps, approx. 3 watts).
Dimensions: 8 3/8" high, 19 1/4" wide, 13 1/4" deep (with cover installed).
Weight: Net 30 lbs. Shipping 45 lbs.
Accessories Available: hp 10503A Cable, BNC to BNC, \$6.50.
hp 11002A Test Leads, banana plug to alligator clip, \$7.50.
Accessories Furnished: Detachable power cord; two 11035A Cables (1 foot long, banana plug to BNC); splash proof cover and storage compartment.
Price: \$990.

Data subject to change without notice.

hp 410B VACUUM TUBE VOLTMETER



**All-Purpose Test Instrument
Measures to 700 MC**

Specifications

AC Voltmeter:

- Range: 1 to 300 v full scale, 6 ranges.
- Frequency Range: 20 cps to 700 MC.
- Frequency Response: Flat within ± 1 db to 700 MC; drops off less than 1 db at 20 cps. Indications obtainable to 3,000 MC.
- Input Impedance: Input capacity 1.5 pf, input resistance 10 megohms at low frequencies. At high frequencies resistance drops off due to dielectric loss.

DC Voltmeter:

- Range: 1 to 1,000 v full scale.
- Input Resistance: Approx. 122 megohms, all ranges.

Ohmmeter:

- Range: 0.2 ohm to 500 megohms in 7 ranges. Midscale readings of 10, 100, 1,000, 10,000, 100,000 ohms, 1 and 10 megohms.

General:

- Accuracy: $\pm 3\%$ of full scale, all ranges, on sinusoidal ac voltages and dc voltages. AC portion of instrument is peak-responding, calibrated in rms volts.
- Power: 115 or 230 v $\pm 10\%$, 50 to 1,000 cps, 40 watts.
- Dimensions: Cabinet Mount: 7 $\frac{3}{8}$ " wide, 11 $\frac{1}{2}$ " high, 8 $\frac{3}{4}$ " deep. Rack Mount: 19" wide, 7" high, 6" deep behind panel.
- Weight: Net 12 lbs. Shipping 17 lbs. (cabinet mount). Net 12 lbs. Shipping 20 lbs. (rack mount).
- Accessories Available: $\text{\textcircled{R}}$ 11039A Capacitive Voltage Divider, 25 kv max., \$150.00, requires $\text{\textcircled{R}}$ 11018A Adapter, \$25.00. $\text{\textcircled{R}}$ 11040A Capacitive Voltage Divider, 2 kv max., \$30.00. $\text{\textcircled{R}}$ 11042A Probe Coax T Connector for Type "N" systems, \$40.00. $\text{\textcircled{R}}$ 11043A Probe Coax "N" Connector adapts to Type "N" systems, \$30.00. $\text{\textcircled{R}}$ 11044A DC Divider, 30 kv max., \$50.00.
- Price: $\text{\textcircled{R}}$ 410B, \$245.00 (cabinet); $\text{\textcircled{R}}$ 410BR, \$265.00 (rack mount).

Audio, ultrasonic, rf and vhf voltages, antenna voltage, dc voltage in high impedance circuits—these are some of the measuring jobs the universally-known $\text{\textcircled{R}}$ 410B can perform swiftly and dependably. This one compact instrument combines an ac voltmeter covering 20 cps to 700 MC, a dc voltmeter with approximately 122 megohms input resistance, and an ohmmeter measuring from 0.2 ohms to 500 megohms.

An important reason for the 410B's perennial popularity is its special diode probe. The probe has very low capacity to minimize disturbance to circuits under test.

Other features of the 410B include low drift (maintains calibration over long periods of time) only one zero adjustment for all ranges, front panel function switching (leads are permanently attached), storage space for leads and probes at rear of the sturdy, lightweight instrument cabinet.

Data subject to change without notice.

hp 410C ELECTRONIC VOLTMETER

Photochopper Permits Zero Drift Multi-function Meter

The *hp* 410C Electronic Voltmeter is an extremely versatile instrument. It will measure dc voltages from 1.5 mv to 1500 volts; dc current from 0.15 nanoamps to 150 ma; resistance from 0.2 ohms to 500 megohms, and, with an optional plug-in probe, ac voltages (20 cps to 700 mc) from 50 mv to 300 volts. These measurements are now made with precision previously unavailable in a single instrument. The easy-to-use *hp* 410C will be valuable in any laboratory, production line or service department.

This compact instrument combines simple construction and operation with high precision. The 410C uses a Hewlett-Packard developed photoconductor-chopper amplifier with a minimum of active components. The amplifier is a hybrid circuit combining the best features of a vacuum tube and two transistors and provides a high input impedance (100 megohms) on the dc voltmeter and a low output impedance (less than 3 ohms) on the recorder output. The amplifier is chopper stabilized and thus eliminates the need for zero adjustment of the dc current, dc voltage and resistance ranges. Additionally, no adjustment of the full scale or infinite resistance is needed. Elimination of zero controls makes this meter the equal of simple pocket-type multi-function meters in ease of operation, yet the *hp* 410C retains the accuracy of a laboratory instrument.

The high sensitivity, low drift and low noise of the neon oscillator/photoconductor chopper-amplifier allow the *hp* 410C to be used as a preamplifier for analog recorders. All the features of this instrument are retained when the measurements are made at dc voltages up to 400 volts off ground. The *hp* 410C has a number of self-protective features so that when overloaded up to 100 times full scale (40 db) it will recover in less than three seconds.

With the *hp* 11036A AC Probe the 410C will measure voltages with 3% accuracy over the range 100 cps to 100 mc. This special probe, with its 1.5 pf capacity, permits 10% accuracy from 20 cps to 700 mc and will produce comparative indications to 3 gc. The high input resistance (10 megohms) and the low capacitance assure minimum loading on the circuit under test.

The low drift of the dc circuit is retained when measuring ac voltages; only an occasional adjustment of the ac zero is necessary. The ac probe responds to positive peak voltages with the meter reading in the rms value of a sine wave. The overload performance is retained when making ac measurements.

The taut-band meter uses a 5:15 scale which permits the greatest number of readings on the upper two-thirds of the meter scale. The range switch is conveniently marked and the combined pilot light and power switch eliminates front panel clutter.

Specifications

DC Voltmeter:

Ranges: 15 mv to 1500 volts full scale in 15, 50, 150 sequence (11 ranges).

Accuracy: $\pm 2\%$ of full scale.

Input Resistance: 100 megohms $\pm 1\%$ on 0.5 v range and above. 10 megohms $\pm 1\%$ on 15 mv, 50 mv, 150 mv ranges.

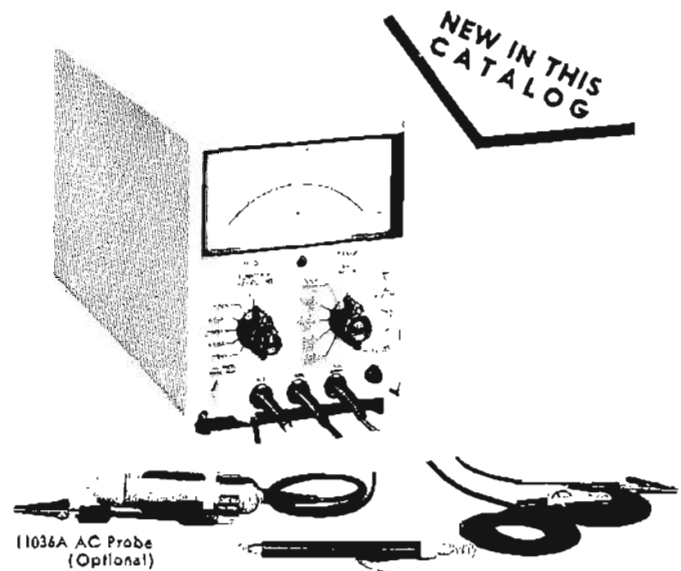

DC Ammeter:

Ranges: $\pm 1.5 \mu\text{amp}$ to 150 ma full scale in 1.5, 5, 15 sequence (11 ranges).

Accuracy: $\pm 3\%$ of full scale.

Input Resistance: Decreasing from 9K on the 1.5 μamp scale to approximately 0.3 ohm of the 150 ma scale.

Special Current Ranges: ± 1.5 , ± 5 and ± 15 namps may be measured on the 15, 50, 150 mv ranges using voltmeter probe; 5% accuracy and 10 megohm input resistance.

Ohmmeter:

Ranges: 10 ohms to 10 megohms center scale (7 ranges).

Accuracy: $\pm 5\%$ at midscale reading.

AC Voltmeter (*hp* 11036A Probe required):

Ranges: 0.5 volt full scale to 300 volts in 0.5, 1.5, 5 sequence (7 ranges).

Accuracy: $\pm 3\%$ of full scale on sinusoidal signals from 100 cps to 100 mc; $\pm 10\%$ from 20 cps to 700 mc. Indications obtainable to 3000 mc.

Input Impedance: Input capacity = 1.5 pf. Input resistance = 10 megohms at low frequencies. At high frequencies dielectric loss lowers impedance.

Meter: Peak-responding; calibrated in rms for sine waves.

Amplifier:

Voltage Gain: 100 maximum, down 3 db at $\frac{1}{2}$ cps.

AC Rejection: 3 db at $\frac{1}{2}$ cps, approx. 66 db at 50 cps and higher frequencies for signals less than 1600 volts peak or 30 times full scale, whichever is smaller.

Output: Proportional to meter indication; 1.5 v at full scale; maximum current is 1 ma.

Output Impedance: Less than 3 ohms at dc.

Noise: Less than 0.5% of full scale.

Drift: Less than 0.02% of full scale/ $^{\circ}\text{C}$.

Overload Recovery: Recovers from 100:1 (40 db) overload in less than 3 seconds.

General:

Power: 115 or 230 volts $\pm 10\%$, 50 to 1000 cps, 13 watts (20 watts with *hp* 11036A AC Probe).

Dimensions: 6-17/32" high, 5 $\frac{1}{8}$ " wide, 11" deep behind panel.

Weight: Net 8 lbs., Shipping approx. 14 lbs.

Price: *hp* 410C, \$300; Option 01, *hp* 11036A AC Probe calibrated with instruments add \$50.

hp 11036A (sold separately), \$60.

Data subject to change without notice.

hp 411A RF MILLIVOLTMETER

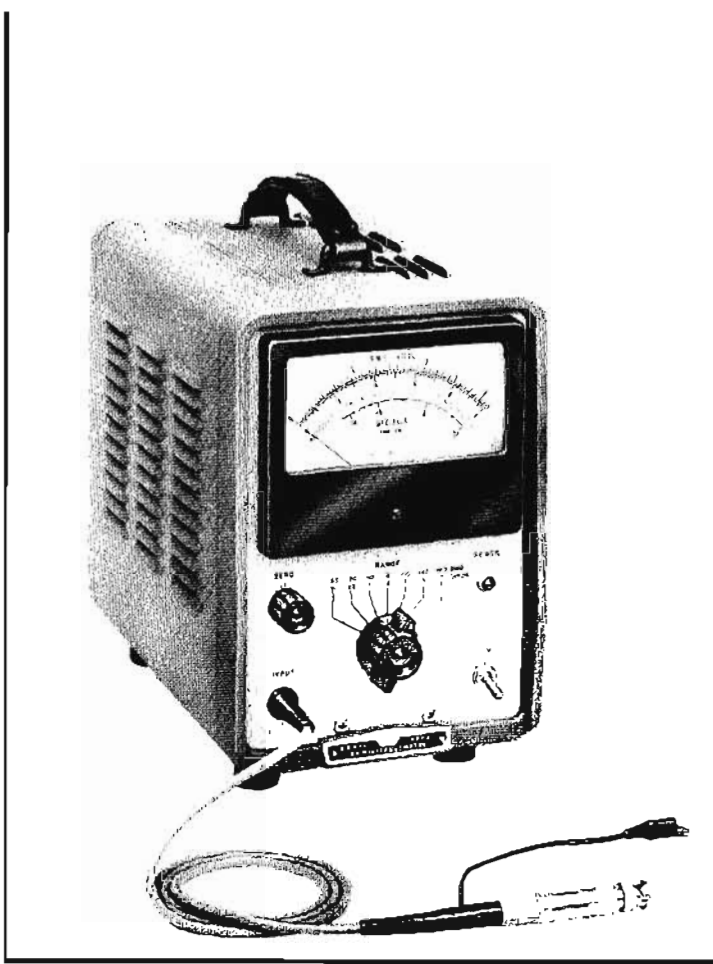

"Touch and Read" Measurement,
3 MV to 10 V,
500 KC to 1,000 MC!

Advantages:

- More measurements with a single instrument
- Reads rf voltage, 500 KC to 1,000 MC
- Measures millivolts at 1 GC
- Full scale ranges 10 mv to 10 v
- Versatile probe tips for wide application
- High resolution on linear scale
- Reads in volts, decibels
- Eliminates annoying thermal drift
- Probe diodes protected against burnout

Uses:

- Laboratory, broadcast, production test department
- Measurements on coaxial lines
- Measurements in terminated coaxial circuits
- Accurate low-level measurements in IF strips
- Low-level measurements at vhf frequencies

Millivolt sensitivity from 0.5 to 1,000 MC, linear voltage scales and low thermal drift make the hp 411A RF Millivoltmeter unique among instruments of its kind.

Although Model 411A measures voltages in the region where detector characteristics are square-law, the meter scales are linear without resorting to complex, difficult to adjust, compensating networks. Two voltage scales in a 1:3 ratio are provided so that you may make most measurements in the more accurate upper two-thirds of the scales. The 1:3 ratio between voltage scales also permits a high-resolution db scale with 10 db between ranges.

Temperature compensation in Model 411A is so effective that rated performance is obtained in an ambient temperature range of 10 to 40°C, even when measuring signals as low as 3 mv.

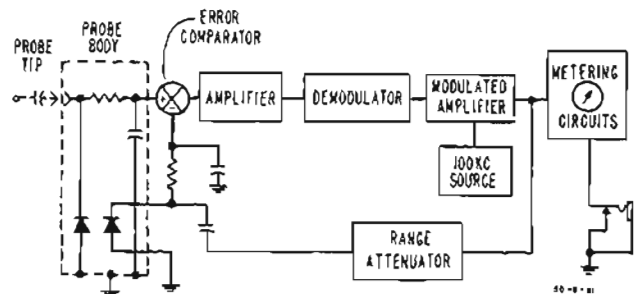

Figure 1. hp 411A Simplified Block Diagram.

Utilizing a new approach, $\text{\textcircled{4}}$ 411A generates, by use of feedback, a low frequency sine wave whose amplitude is equivalent to that of the rf signal input. This low frequency signal is metered, indicating the magnitude of the input rf signal.

The general operation can be seen from the block diagram shown in Figure 1. The input rf is detected by a semiconductor diode, and the resulting dc signal is fed into an error detector. Any difference between it and the feedback reference is amplified and used to control the output of a modulator operating on a 100 KC carrier.

The magnitude of the 100 KC output is proportional to the magnitude of the error signal. The modulator output is fed back through the range attenuator to a second diode whose detection characteristics are closely matched to those of the rf detector. The resulting dc is used as the reference for the error detector. As long as the loop gain is high, the error will tend toward zero.

Since the two detected dc voltages are approximately equal and the detection characteristics of the diode detectors are the same, the effective amplitude of the low frequency feedback signal must be equal to that of the input rf. Thus, a measure of the amplitude of the feedback 100 KC is equivalent to a measure of the input rf regardless of any non-linearity in the detector characteristics.

Temperature compensation in Model 411A is accomplished by placing the two detector diodes in close thermal proximity in the rf probe. Even though their detection characteristics change with temperature, they change in the same manner. In this way the two diodes maintain their match over a wide temperature range.

Photoelectric Chopper

Other features offered in the 411A include an $\text{\textcircled{4}}$ developed photoelectric chopper to eliminate contact noise, guarantee high sensitivity, and provide freedom from zero-drift; an output for galvanometer recording; accessory probe tips for use in a wide variety of circuits (for measuring on as well as at the termination of coax transmission lines), and a capacity divider increasing 411A voltage capability to 1,000 v. A coupling capacitor in the probe protects diodes from high-current transients when the probe is connected to potentials up to 300 v dc.

When measuring terminal voltages on coaxial lines it is often desirable to terminate the line with a low reflection load such as the $\text{\textcircled{4}}$ Model 908A Coaxial Termination (see page 241).

In this application the $\text{\textcircled{4}}$ 11024A Type N Tee Probe Tip is used with the 908A. Model 908A terminates the line and the "T" makes a convenient connection for the voltmeter.

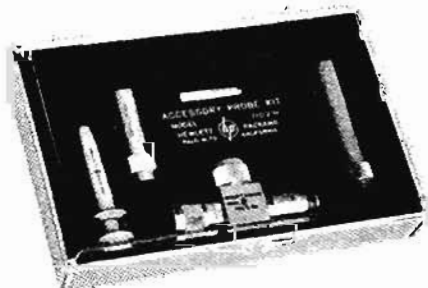

$\text{\textcircled{4}}$ 11027A Accessory Probe Kit. Contains probe tips to meet all measurement requirements normally encountered. The storage case has room for the BNC tip furnished with the instrument. See specifications for details.

Specifications

Voltage Range: 10 mv rms full scale to 10 v rms full scale in seven ranges. Full scale readings of 0.01, 0.03, 0.1, 0.3, 1, 3 and 10 v rms.

Frequency Range: 500 KC to 1 GC with accessory probe tips. Usable indications to 4 GC.

Accuracy: 500 KC to 50 MC, $\pm 3\%$ of full scale; 50 MC to 150 MC, $\pm 6\%$ of full scale; 150 MC to 1 GC, ± 1 db.

Meter Scales: Two linear voltage scales, 0 to 1 and 0 to 3, calibrated in the rms value of a sine wave. DB scale, calibrated from +3 to -12 db = 1 mw in 50 ohms.

Input Resistance: Depends on probe tip, frequency and input voltage; typically 200 K ohms at 1 MC and 1 volt.

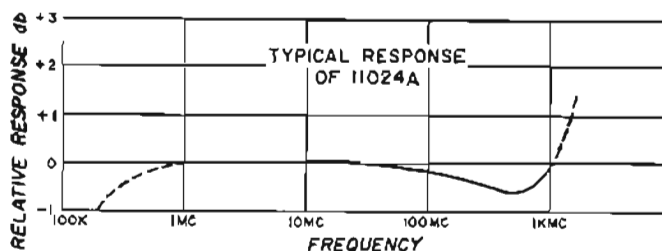

Figure 2. Typical frequency response of $\text{\textcircled{4}}$ 11024A Type N "T" Probe Tip.

Probe Tip Furnished: 11025A BNC Open Circuit Probe Tip, 500 kc to 500 mc. Maximum input: 200 v dc.

Accessories available at additional cost:

Probe Tips: 11022A Pen Type Probe Tip, 500 kc to 50 mc. Shunt capacity: less than 4 pf. Maximum input: 200 v dc. Price \$25.00. 11023A VHF Probe Tip, 500 kc to 250 mc. Shunt capacity: less than $2\frac{1}{2}$ pf. Maximum input: 200 v dc. Price, \$20.00.

11024A Type N "Tee" Probe Tip, 1 mc to 1 gc. SWR is less than 1.15 when terminated in 50 ohms. Maximum input: 10 v dc. Price, \$40.00.

11026A 100:1 Capacity Divider Probe Tip, 1 mc to 250 mc. Division accuracy: $\pm 1\%$; Shunt capacity: 2 pf. Maximum input: 1,000 v pk (dc + pk ac). Price, \$35.00.

Probe Kit: 11027A Accessory Probe Kit. This kit includes the 11022A, 11023A, 11024A, 11026A Probe Tips and a replacement diode cartridge, 411A-21-3, in a convenient storage case, Price, \$152.50.

50-ohm Termination: $\text{\textcircled{4}}$ Model 908A Coaxial Termination. (See page 241.)

Galvanometer Recorder Output: Proportional to meter deflection, 1 ma into 1,000 ohms at full scale deflection.

Power: 115 or 230 v $\pm 10\%$, 50 to 60 cps, 35 watts.

Dimensions: Cabinet Mount: $11\frac{3}{4}$ " high, $7\frac{1}{2}$ " wide, 12" deep. Rack Mount: $6 - 31/32$ " high, 19" wide, $10\frac{3}{8}$ " deep behind panel.

Weight: Net 12 lbs. (cabinet); 15 lbs. (rack). Shipping, 18 lbs. (cabinet); 28 lbs (rack).

Price: $\text{\textcircled{4}}$ 411A, \$450.00 (cabinet); $\text{\textcircled{4}}$ 411AR, \$455.00 (rack mount).

Data subject to change without notice.

412A PRECISION DC VOLTMETER-OHMMETER-AMMETER

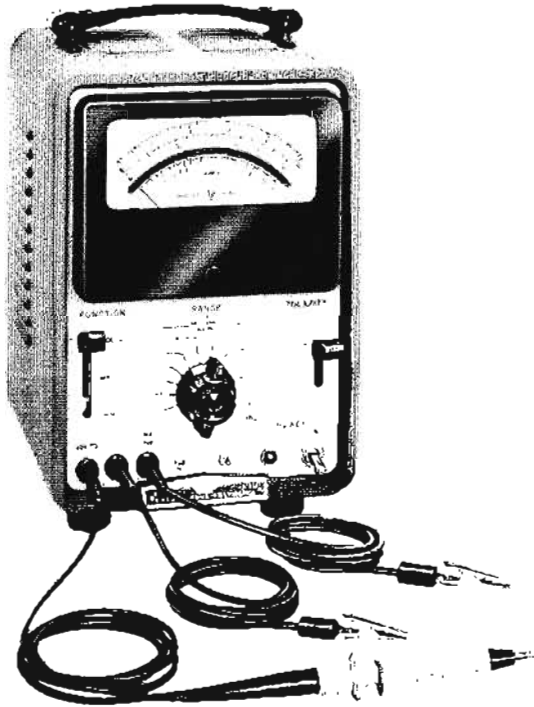

1% Accuracy VTVM
is Also Precision
Ohmmeter, Ammeter

Here is one compact instrument that makes all normally used dc measurements with precision and simplicity.

The  412A provides 1% voltage and 2% current measurement accuracy. The unusually wide ohmmeter range covers from 1 ohm center scale to 100 megohms center scale so that resistance measurements can be made on wire sections as short as 6 inches or across insulators as high as 5,000 megohms.

The sensitivity and precision of the 412A are due in part to fresh circuitry concepts. For example, an exclusive  developed photoconductor chopper virtually eliminates dc drift and offset. No zero set control is needed. The 412A is thus an ideal dc preamplifier for a recorder or other applications. Output terminals are provided.

The 412A insures accurate readings regardless of test conditions. Input is floating and input resistance is high, thereby avoiding errors due to loading circuits or insertion of ground connections. A very high degree of ac rejection insures that readings are accurate even in the presence of ac signals.

Data subject to change without notice.

Specifications

Voltmeter:

Voltage Range: Pos. and neg. voltages from 1 mv to 1,000 v full scale. 13 ranges.

Accuracy: $\pm 1\%$ of full scale on any range.

Input Resistance: 10 megohms $\pm 1\%$ on 1 mv, and 3 mv, and 10 mv ranges.

30 megohms $\pm 1\%$ on 30 mv range.

100 megohms $\pm 1\%$ on 100 mv range.

200 megohms $\pm 1\%$ on 300 mv range and above.

Ammeter:

Current Range: Pos. and neg. currents from 1 μ amp to 1 amp full scale. 13 ranges.

Accuracy: $\pm 2\%$ of full scale on any range.

Input Resistance: Decreasing from 1,000 ohms on 1 μ amp scale to 0.1 ohm on 1 amp scale.

Ohmmeter:

Resistance Range: Resistance from 1 ohm to 100 megohms center-scale. 9 ranges.

Accuracy: $\pm 5\%$ of reading, 0.2 ohm to 500 megohms.

$\pm 10\%$ of reading, 0.1 to 0.2 ohm and 500 megohms to 5,000 megohms.

Amplifier:

Voltage Gain: 1,000 maximum.

AC Rejection: 3 db at 1 cps, approx. 80 db at 50 and 60 cps.

Output: Proportional to meter indication; 1 v at full scale; maximum current, 1 ma. (Full scale corresponds to 1.0 on upper scale.)

Output Impedance: Less than 2 ohms at dc.

Noise: Less than 0.1% of full scale on any range.

Drift: Negligible.

Common Signal Rejection: May be operated up to 500 v dc, or 130 v ac above ground.



Power: 115 or 230 v $\pm 10\%$ 50 to 60 cps, 35 watts.

Dimensions: Cabinet Mount: 11 $\frac{1}{2}$ " high, 7 $\frac{1}{2}$ " wide, 10" deep.

Rack Mount: 5 $\frac{1}{4}$ " high, 19" wide, 7 $\frac{1}{2}$ " deep behind panel.

Weight: Net 12 lbs. Shipping 17 lbs. (cabinet mount). Net 12 lbs.

Shipping 19 lbs. (rack mount).

Price:  412A, \$400.00 (cabinet);  412AR, \$405.00 (rack mount).

hp 413A DC NULL VOLTMETER

Floating, High Impedance Input; 1 MV End Scale Sensitivity

Specifications

Voltmeter:

Ranges: Positive and negative voltages from 1 mv to 1,000 v end scale in thirteen zero-center ranges.

Accuracy: $\pm 2\%$ of end scale value.

Input Resistance: 10 megohms on 1, 3, and 10 mv ranges.

30 megohms on 30 mv range.

100 megohms on 100 mv range.

200 megohms on 300 mv range and above.

AC Rejection: A voltage at power line or twice power line frequency 40 db greater than full scale affects reading less than 1%. Peak voltage must not exceed 1,500 v.

Limits of Zero Control: More than \pm end scale value on any range when using expanded scale.

Amplifier:

Voltage Gain: 0.001 to 1,000 in thirteen steps.

Gain Accuracy: $\pm 1\frac{1}{2}\%$.

Gain Linearity: $\pm 0.2\%$.

Noise: Less than 0.1% (rms) of end scale on any range.

Output: 1 volt for end scale deflection, same polarity as input signal. End scale corresponds to 1.0 on upper scale. Maximum load current 1 ma.

Output Impedance: Less than 2 ohms at dc.

Output Terminals: Dual banana jacks.

AC Rejection: Approximately 3 db at 1 cps, 80 db at 50 and 60 cps.

General:

Input Terminals: Dual banana jacks.

Input Isolation: Greater than 100 megohms shunted by 0.1 μ f to instrument case (power line ground).

Common Signal Rejection: May be operated up to 500 v dc, or 130 v ac above ground.

Power: 115 or 230 volts $\pm 10\%$, 50 to 60 cps, 35 watts.

Dimensions: Cabinet Mount: 11 $\frac{1}{2}$ " high, 7 $\frac{1}{2}$ " wide, 10" deep.

Rack Mount: 5 $\frac{1}{4}$ " high, 19" wide, 7 $\frac{1}{2}$ " deep behind panel.

Weight: Net 12 lbs. Shipping 16 lbs. (cabinet). Net 12 lbs. shipping 19 lbs. (rack mount).

Price: Φ 413A, \$350.00 (cabinet); Φ 413AR, \$355.00 (rack mount).

Data subject to change without notice.

Model 413A uses the sensitive and precise circuitry of Φ 412A (opposite page) to provide a dc null voltmeter of outstanding stability and resolution. Model 413A has 13 zero-centered ranges, running from 1 mv to 1,000 volts end scale. The input terminals are isolated from ground, allowing operation up to 500 volts dc or 130 volts ac from ground potential. When using expanded zero, the meter pointer may be set to either end scale position to measure voltages up to twice end scale values (maximum input is 1,500 v).

High input impedance, (10 megohms on the most sensitive range, 200 megohms on 300 mv range and above) makes the Model 413A especially valuable in resistance bridge measurements. Accuracy of this instrument is within 2% of end scale; drift and noise are virtually imperceptible.

Because the dc null voltmeter provides an output proportional to meter deflection, Φ 413A is useful as an indicating and control device. For instance its high voltage gain (1,000 on the 1 mv range), high stability and low noise make the Φ 413A desirable for amplifying the output of a thermocouple in control systems. The Zero control may be used to set an arbitrary reference.

For dc voltmeter use, Φ 413A offers high input impedance, voltage ranges from 1 mv to 1,000 volts end scale, 2% accuracy and virtually drift-free operation.

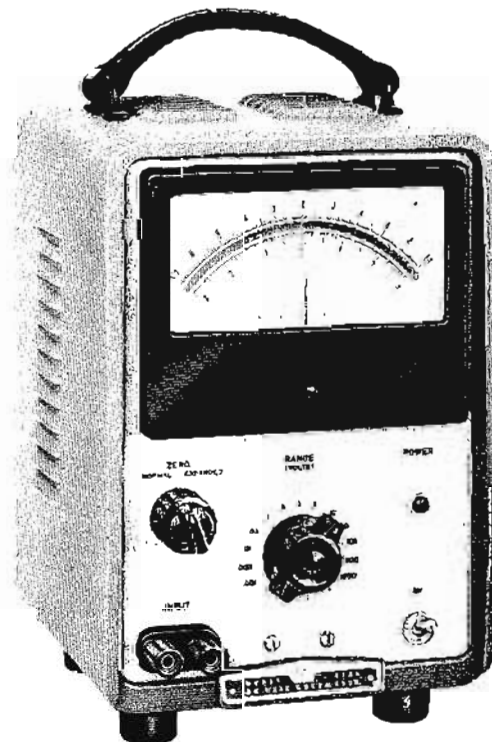

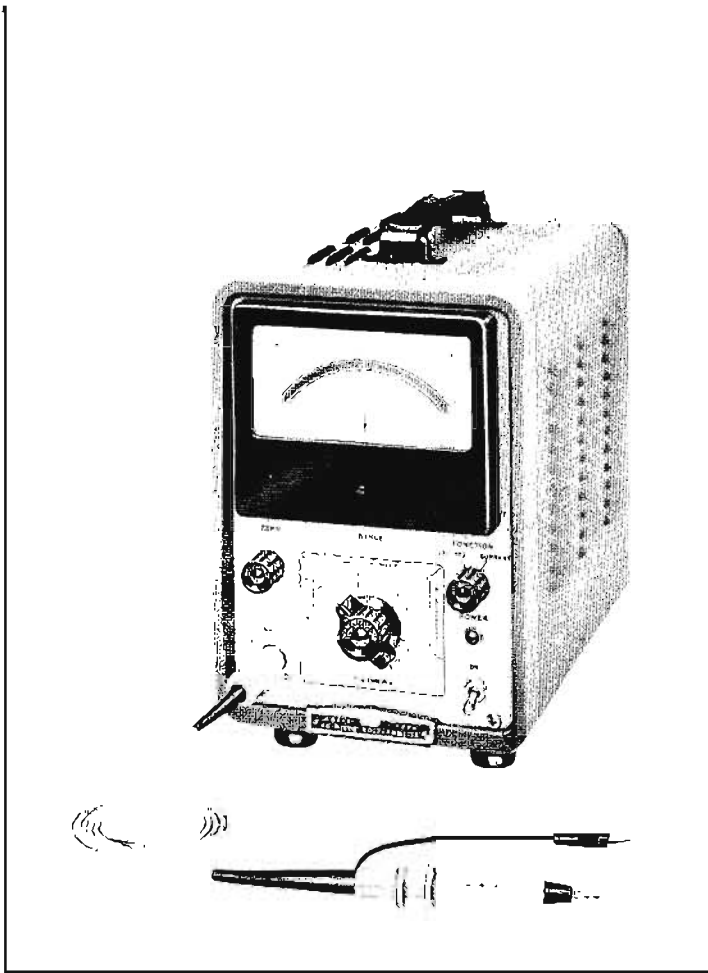

hp 425A

DC MICROVOLT-AMMETER

Read Directly 1 μa and 1 μv
with Compact, Portable Instrument

Specifications

Microvolt-Ammeter

Voltage Range: Pos. and neg. voltages from 10 μv end scale to 1 v end scale, 11 steps, 1-3-10 sequence.
Current Range: Pos. and neg. currents from 10 μa end scale to 3 ma end scale, 18 steps, 1-3-10 sequence.
Input Impedance: Voltage Ranges: 1 megohm \pm 3%. Current Ranges: Depends on range, 1 megohm to 0.33 ohm.
Accuracy: Within \pm 3% of end scale. Line frequency variations \pm 5 cps affect accuracy less than \pm 2%.

Amplifier

Gain: 100,000 maximum.
AC Rejection: At least 3 db at 1 cps, 50 db at 50 cps and approximately 60 db or more above 60 cps. A power line frequency or twice power line frequency signal 40 db greater than end scale causes less than 1% error.
Output: 0 to 1 v for end scale reading, adjustable (5,000 ohm shunt potentiometer), 1 ma maximum at 1 v output.
Output Impedance: Depends on setting of output potentiometer; 10 ohms when potentiometer is set for maximum output.
Noise: Less than 0.2 μv rms (typically less than 1.2 μv p-p) referred to the input.
Drift: After 15 minutes warmup drift is less than \pm 4 μv per day referred to input.

General

Power: 115 or 230 v \pm 10%, 60 cps, 40 watts. 50 cps operation on special order.
Dimensions: Cabinet Mount: 7 $\frac{3}{8}$ " wide, 11 $\frac{3}{4}$ " high, 12" deep. Rack Mount: 19" wide, 7" high, 11" deep behind panel.
Weight: Net 17 lbs. Shipping 23 lbs. (cabinet mount). Net 21 lbs. Shipping 30 lbs. (rack mount).
Accessories Available: $\text{\textcircled{C}}$ 11021A 1,000:1 Divider Probe, increases range of 425A to 1,000 volts. Division accuracy \pm 2%, input resistance 10 megohms. \$55.00.
Price: $\text{\textcircled{C}}$ 425A, \$500.00 (cabinet); $\text{\textcircled{C}}$ 425AR, \$505.00 (rack mount).
Option 01: For operation from 50 cps power, no extra charge.

Data subject to change without notice.

Hewlett-Packard 425A DC Microvolt-Ammeter makes measurements of extremely small dc voltages and currents without requiring expensive arrays of complex equipment, even in the presence of relatively strong ac signals.

No Mechanical Vibrator

Two important circuit aspects include very heavy ac filtering and the substitution of a photoelectric chopper developed by $\text{\textcircled{C}}$ to replace the conventional error-inducing mechanical vibrator. Every known assurance of safety, accuracy and dependability has been incorporated; momentary overloads of 1,000 volts cause no damage; the pickup probe minimizes thermocouple and triboelectric effects.

To assure that unwanted ac on the dc input does not disturb the meter indication, frequency response is down about 3 db at 1 cps, down 50 db at 50 cps, and down approximately 60 db at 60 cps.

Drift-Free Amplifier

The amplifier provides a 1 volt output for end scale deflection or a 1 ma output into 1,000 ohms to drive a potentiometer or galvanometer recorder. For driving sensitive potentiometer recorders, the 425A includes a built-in potentiometer for reducing output voltage.

Model 425A has an inherent input impedance much higher than specified and a 1 megohm resistor directly across the input insures a constant input impedance. If an unusually high input impedance is required, the input resistor can be removed to provide greater than 200 megohms input impedance.

hp 405BR,CR AUTOMATIC DC DIGITAL VOLTMETERS

Touch and Read Convenience, Automatic Range and Polarity Selection

Specifications

Range: 0.001 to 999 volts, dc.

Presentation: 3 illuminated figures, with decimal and polarity sign.

Accuracy: Within $\pm 0.2\%$ of reading ± 1 count.

Floating Input: Permits measurement of systems operating within ± 500 volts dc of power line ground.

Range, Polarity Selection: Automatic. Hold control disables automatic range selection and permits manual range choice.

Ranging Time: 0.2 seconds to 2 seconds, depending on range change required.

Input Impedance: 11 megohms to dc on all ranges.

Sample Rate: Internal: Maximum, between 4 and 5 per second.
Minimum, one every 5 seconds.

External (405CR only): Controlled by 20 volt positive pulse, maximum rate five per second.

Response Time: Less than 1 second to step function.

Input Filter ac Rejection: 3 db at 1.5 cps, nominally 44 db at 60 cps.

Output: (405CR only).

- (1) 10-line decimal code for operating $\text{\textcircled{h}}$ Model 561B Digital Recorder or K05-405A remote indicator.
- (2) Single-line voltage coded decimal (staircase), for operating $\text{\textcircled{h}}$ Model 560A Digital Recorder, with use of the 405A-95C adapter.
- (3) A print command for $\text{\textcircled{h}}$ digital recorders is issued after every sample, except when the 405CR is ranging.

Power: 115 or 230 volts $\pm 10\%$, 50 to 60 cps, 180 watts.

Dimensions: 7" high, 19" wide, 13 $\frac{7}{8}$ " deep behind panel.

Weight: Net 31 lbs. Shipping 46 lbs.

Accessories Available: $\text{\textcircled{h}}$ 457A AC-to-DC Converter. (See page 102.)

Price: $\text{\textcircled{h}}$ 405BR, \$890.00. $\text{\textcircled{h}}$ 405CR, \$960.00. (Both rack mount.)

Data subject to change without notice.

Remarkable simplicity of use is an outstanding feature of the $\text{\textcircled{h}}$ 405BR,CR Digital Voltmeters. Just touch the probe to the voltage to be measured, and the 405BR,CR automatically zero-sets itself, chooses the proper voltage range and polarity, and displays the result in bright, clear numerals, complete even to the polarity sign and decimal point. Operator errors are reduced to the vanishing point!

For repeated readings in the same voltage range, the automatic feature can be disabled and the decimal can be positioned manually.

Three digit resolution on all voltages between 1 and 1,000 volts allows the observation of very small changes, and accuracy is held to $\pm 0.2\%$ of the reading on all ranges ± 1 count. For maximum usability in various environments, the input is isolated from ground (allowing voltage difference measurements), dc input impedance is 11 megohms on all ranges, and ac rejection reaches the 3 db point at 1.5 cps.

For systems applications, the $\text{\textcircled{h}}$ 405CR is offered. This instrument is similar to $\text{\textcircled{h}}$ 405BR but has provision for an external sampling command and recording outputs both in ten-line decimal code and one-line staircase code, as well as a print command for operating $\text{\textcircled{h}}$ 560A, 561B Digital Recorders.

Versatility, operating simplicity and reasonable price make $\text{\textcircled{h}}$ 405BR,CR Automatic DC Digital Voltmeters solid investments for the laboratory, production line, or systems console.

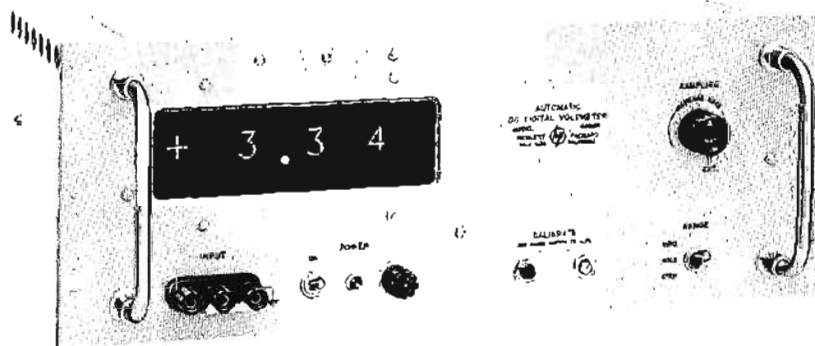

$\text{\textcircled{h}}$ 405CR

457A AC-TO-DC CONVERTER

High Accuracy AC Measurements to 500 KC With Digital Voltmeter

Specifications

Input Range: 100 μ v to 300 volts rms, in 4 decade ranges corresponding to 1, 10, 100, and 1,000 v rms full scale. Over-ranging to 200% of full scale, all ranges except 1000 v.

Frequency Range: 50 cps to 500 KC.

Accuracy: $\pm 0.3\% \pm 1$ mv from 50 cps to 50 KC. $\pm 0.75\% \pm 1$ mv from 50 KC to 500 KC.

Floating Input: Permits measurement of ac voltages at dc potentials of ± 500 v above power line ground.

Output: 0 to 1.0 v dc, responding to average value of ac input, with output calibrated as rms value of sine wave. Input step attenuation of 1, 10, 100, or 1,000.

Output Impedance: 10,000 ohms.

Input Impedance: 1 megohm, shunted by 30 pf.

Power: 115 or 230 volts $\pm 10\%$, 50 to 1,000 cps, approximately 31 watts.



Dimensions: 16 $\frac{3}{4}$ " wide, 3 $\frac{3}{4}$ " high, 13 $\frac{3}{4}$ " deep.

Weight: Net 12 lbs. Shipping 20 lbs.

Accessories Available: 1110A Current Probe, \$100.00; 10100B Feed-Through Termination, \$17.50; 11000A Cable, \$4.50; 11001A Cable, \$5.50.

Price:  457A, \$395.00.

Data subject to change without notice.

With a dc digital voltmeter  457A is the ideal converter for many digital systems requiring that ac voltages be presented in digital form for entry into card punches or automatic testing systems. It can also be used with  405CR Digital Voltmeter and an  560 series Digital Recorder to provide a permanent record in printed digital form.

A frequency range from 50 cps to 500 KC is covered with conversion accuracy of $\pm 0.75\%$ of full scale ± 1 mv. Even greater accuracy is obtained for signals under 50 KC. When Model 457A is used with  405BR/CR Digital Voltmeters, ac voltage measurements can be made with three-digit resolution and overall accuracy of $1\% \pm 2$ counts from 50 cps to 500 KC. From 50 cps to 50 KC accuracy is $0.5\% \pm 2$ counts.

Model 457A is an average-responding, rms calibrated ac-to-dc converter. Thus, a one volt rms sine wave input provides a one volt dc output.

Ranging is accomplished by input attenuation so that the output dc voltage is always between 0 and 1 volt dc. Attenuation ratios are 1:1, 10:1, 100:1, and 1,000:1 with highest rated input of 300 volts rms.

A new modular cabinet design provides easy access to the instrument chassis. The modular design facilitates stacking of instruments on the test bench. Or, if rack mounting is desired, two end brackets supplied with the instrument may be attached quickly.

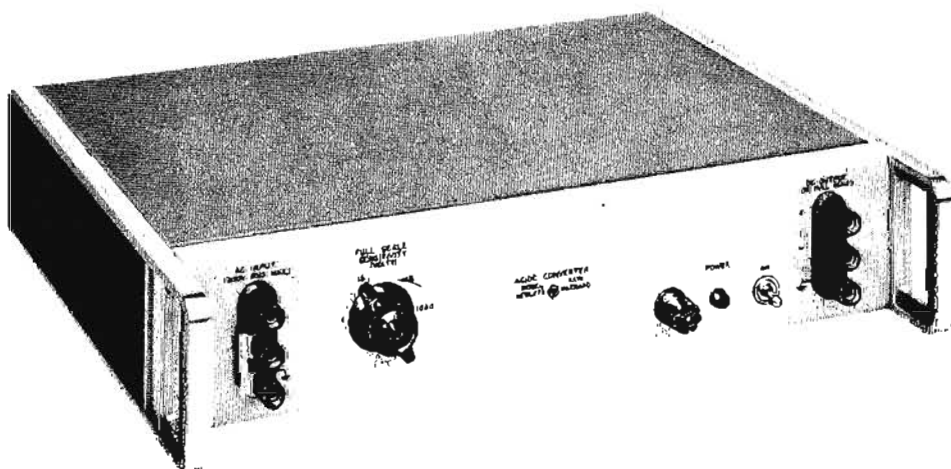

DYMEC DY-2401A INTEGRATING DIGITAL VOLTMETER

The DY-2401A Integrating Digital Voltmeter, offered by Dymec Division of Hewlett-Packard, provides 140 db effective common mode rejection at all frequencies, including dc, and minimizes error due to noise unavoidably superimposed on the input signal. It has 5 full scale voltage ranges from 100 millivolts to 1000 volts, is fully programmable and provides BCD output.

Unusually accurate operation in the presence of noise is derived from the fully floated and guarded input circuitry of the DY-2401A. Other features include 5-digit in-line readout, $\pm 300\%$ overranging on the four most sensitive ranges. The DY-2401A will also directly measure frequency from 10 cps to 300 kc.

For ac and resistance measurements with the DY-2401A, the DY-2410A AC/Ohms Converter permits measuring ac voltage from 100 mv full scale to 750 volts peak, 50 cps to 100 kc; plus resistance from 100 ohms to 10 megohms full scale with 300% overranging. The DY-2410A is programmable and floated and guarded.

To broaden the application capability of the DY-2401A while fully maintaining its accuracy and noise rejecting qualities, the DY-2411A Guarded Data Amplifier may be used. It may be operated with a gain of $+1$ or $+10$. In the latter mode, the DY-2401A is a 10 mv full scale digital voltmeter.

Specifications DY-2401A

Voltage Ranges: 1-second sample period 99.999 mv, 999.99 mv, 9.9999 v, 99.999 v, 999.99 v; 0.1-second sample period 100.00 mv, 1.0000 v, 10.000 v, 100.00 v, 1000.0 v; 0.01-second sample period 0100.0 mv, 01.000 v, 010.00 v, 0100.0 v, 01000. v.

Noise Rejection: Overall effective common mode rejection: 140 db at all frequencies, 160 db at dc (0.1 sec sample period). Common mode rejection; 120 db at 60 cps, 160 db at dc with 1000 ohms between low side of source and low side of voltmeter input. Superimposed noise rejection: More than 20 db at 55 cps for 0.1 sec sample period; increases 20 db per decade increase in frequency. Infinite rejection at frequencies evenly divisible by 10.

Display: 5-digit Nixie tube readout. Polarity, decimal, measurement units, overload condition indicated automatically.

Linearity: $\pm 0.005\%$ of full scale.

Stability: $\pm 0.01\%$.

Internal Calibration: Provides stability of $\pm 0.01\%$ per 6 months.
Input Impedance: 10 megohms, 10 volt, 100 volt, 1000 volt ranges; 1 megohm, 1 volt range; 100,000 ohms, 0.1 volt range.
Measuring Speed: 1 reading/second with 1 second sample period. 9 readings/second with 0.1 second sample period. 80 readings/second with 0.01 second sample period.
Frequency Measurement Range: 10 cps to 300 kc.
Recorder Output: BCD output referenced to ground.
Dimensions: 7" high, 19" wide, 18 $\frac{3}{8}$ " deep.
Weight: Net 48 lbs. Shipping 70 lbs.
Price: \$3950.

Specifications

DY-2410A when used with DY-2401A

AC Voltage Ranges: Five ranges, 100 mv to 1000 v rms full scale, 300% overranging on four lower ranges, 1000 v range usable to 750 v peak.

Frequency Range: 50 cps to 100 kc.

Noise Rejection: Effective common mode rejection 110 db at 60 cps.

For Resistance Measurements: Measuring Ranges: 100 ohms to 10 megohms full scale with 300% overranging on 5 lower ranges.
Dimensions: 7" high, 19" wide, 17 $\frac{1}{4}$ " deep.

Weight: Net 43 lbs. Shipping 60 lbs.

Price: AC/ohms (DY-2410A), \$2250; ac only (DY-2410A-M1), \$1850; ohms only (DY-2410A-M2), \$1650.

Specifications

DY-2411A when used with DY-2401A

Ranges: $+1$ gain, $+10$ gain or bypass, programmable or set manually.

Full Scale Input: 10.5 v on $+1$ gain, 1.05 v on $+10$ gain, 1000 v on bypass.

Noise Rejection: 134 db (combined with DY-2401A).

Input Resistance: 10^{10} ohms.

Drift: Less than 1 μ v per week.

Noise: $\pm 2 \mu$ v for DY-2401A 1-second sample period, $\pm 5 \mu$ v for DY-2401A 0.1-second sample period.

Gain Accuracy: $+1$ gain $\pm 0.002\%$, $+10$ gain $\pm 0.007\%$.

Dimensions: 3 $\frac{1}{2}$ " high, 16 $\frac{3}{4}$ " wide, 11 $\frac{1}{8}$ " deep; hardware furnished converts unit to 19" wide rack mount.

Weight: Net 17 lbs. Shipping 26 lbs.

Price: \$1150.

Data subject to change without notice.

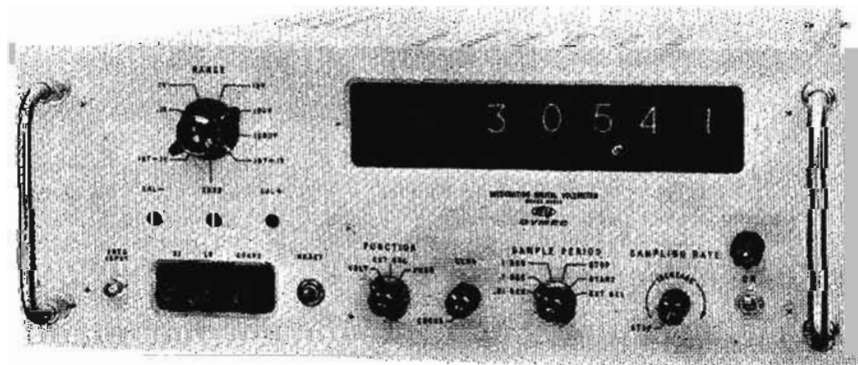

DY-2401A

3440A DIGITAL VOLTMETER

Interchangeable Plug-Ins Increase Voltmeter Versatility

Advantages:

- Four-digit readout, visual and electrical
- 0.05% accuracy
- High input impedance, 10.2 megohms
- Compact size, 5¼" panel height
- All solid state circuitry, rugged and reliable
- Improved readability with new rectangular display tubes
- Floating input
- Easy to operate



Uses:

- Production line, quality control, receiving inspection, calibration laboratory, and research and development laboratory measurements of: dc voltage, ac voltage, dc current and resistance
- Systems programmable voltmeter
- Automatic data recording

The *hp* Model 3440A Digital Voltmeter is a compact, accurate, rapid and multiple-function digital voltmeter with two plug-in accessories. These accessories offer the choice of rapid automatic ranging, remote programming or manual operation. The basic voltmeter is solid state (no mechanical steppers) with easy-to-service plug-in circuit cards mounted in the Hewlett-Packard modular enclosure.

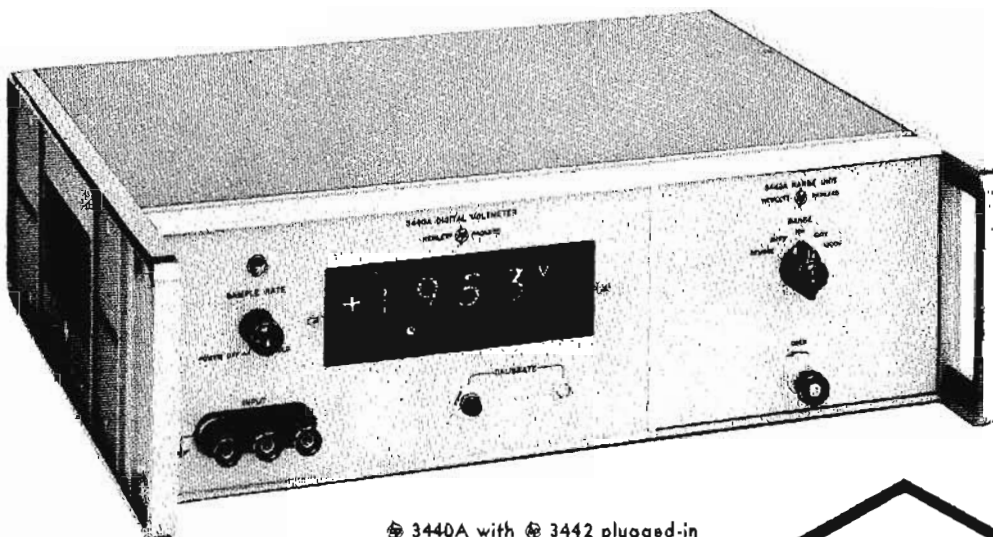
DC voltages up to 999.9 volts of either polarity are displayed in four significant digits with an error of less than $\pm 0.05\% \pm 1$ digit and with the polarity of the applied signal indicated automatically. Use of the 3440A with the *hp* 457A AC-to-DC Converter (page 102) permits accurate measurements of ac voltages from 50 cps to 500 kc. Decimal points for range are located manually with the 3441A Range Selector or automatically with the 3442A Automatic Range Selector. The bright, easy-to-read display of digits with polarity and range indication reduces errors by the operator. A polarized light filter stops the reflection of external light so that a good contrast results when the digits are lit.



 3440A with  3442 plugged-in

**AVAILABLE
FALL 1963**

Accuracy and Speed

The 3440A Digital Voltmeter has a total error of less than $\pm 0.05\%$ of reading ± 1 digit over the ambient temperature range of $+15^{\circ}\text{C}$ to $+40^{\circ}\text{C}$, and to 5% above full scale range. With easy-to-make calibration against the internal standard voltage, $\pm 0.1\%$ accuracy can be maintained over the wide range of 0°C to 55°C . A line voltage variation of $\pm 10\%$ does not decrease the overall accuracy.

The accuracy of the 3440A remains unaffected at high sample rates of 5 per second when a constant voltage remains on the input terminals. When a step voltage is applied to the input ac filter (which has a rejection of 30 db at 60 cps) the response time of the filter is such that only $\frac{1}{4}$ second is required for the 3440A to reach 99.9% of full value.

The input signal pair may be floated at up to 400 volts above chassis ground without affecting accuracy. An additional feature which results in consistent high accuracy is the constant 10.2-megohm impedance. This impedance presents a constant load to the circuit under measurement and does not upset critical circuits.

AC Voltage Measurements

AC potentials up to 300 volts rms (50 cps to 500 kc) can be measured accurately and rapidly by adding an *hp* 457A AC-to-DC Converter. The 3440A and the inexpensive 457A converter are matched in impedance so the combined errors will be less than $\pm 0.4\%$ of reading for voltages in the 50-cps to 50-kc region. Since the 457A is also floating, ac potentials that are as much as 400 volts dc above chassis ground can be measured.

Electrical Readout

Each of the four digits, with polarity and decimal range, is represented by four-line, binary-coded decimal voltages in the 1-2-2-4 weighted code. The decimal, polarity and the four digits are in parallel-coded form and are completely compatible with the *hp* 562A Digital Recorder which will print the information in 6 columns. Because the storage capability of the 562 recorder is usable with the voltmeter, the full 5 per second sample rate is retained when recording. With a parallel to serial converter, such as the Dymec Models DY-2540 and DY-2545A, the data can be entered into serial entry machines such as electric typewriters, tape punches and card punches.

Plug-In Units

The *hp* 3441A Range Selector is a plug-in accessory with a range switch to select one of three voltage ranges, 9.999, 99.99, or 999.9. The *hp* 3442A Automatic Range Selector is also available for use with the 3440A Digital Voltmeter. This versatile selector retains the manual range selection of the basic instrument and adds the automatic and programmable range features. In the automatic mode the 3440A, 3442A will select its voltage range automatically. When a need for range change is sensed the voltmeter sample rate is automatically increased if the sample rate is not already at the maximum rate of 5 per second. During this period the correct range is selected and the voltage at the input filter reaches its final value.

For a rapid system operation, the remote mode offers the capability of changing range on remote command. Upon grounding a remote line, the unit will change range within 25 milliseconds, and a sample can be started. The remote programming mode allows the 3440A Digital Voltmeter to be used in digital data acquisition systems with input scanners such as the Dymec DY-2901 Input Scanner/Programmer.



3441

Specifications

Voltage Range: 4-digit presentation of 9.999, 99.99, and 999.9 volts full scale with 5% overrange capability and overload indicator.

Accuracy: $\pm 0.05\%$ of reading ± 1 digit with line voltage variations of $\pm 10\%$ from nominal and with temperature between $+15^{\circ}\text{C}$ and $+40^{\circ}\text{C}$; $\pm 0.1\% \pm 1$ digit for temperature range of 0°C to $+55^{\circ}\text{C}$.

Sample Rate: 5 samples per second to 1 per 5 seconds.

Range Selection:

With 3441A: Manual.

With 3442A: Manual, Automatic and Programmed.

Range Change Speed: Automatic; achieves new reading 500 ms after new voltage is applied. Programmed; within 25 ms.

Input Impedance: 10.2 megohms (to dc) all ranges.

Input Filter AC Rejection: 30 db at 60 cps increasing at 12 db per octave.

Input Filter Response Time: Less than 280 msec to a step function.

Polarity: Automatic indication.

DC Isolation: Signal pair may be operated at up to 400 volts dc above chassis ground.

Electrical Readout: 6 columns consisting of 4 digits, polarity and decimal of four-line BCD with weighting of 1-2-2-4. "0" is — 24 volts and "1" is — 1 volt with 100K output impedance.

Power: 115 or 230 volts $\pm 10\%$, 50 to 60 cps, approximately 20 watts.

Dimensions: $5\frac{1}{4}$ " high, $16\frac{3}{4}$ " wide, $11\frac{1}{2}$ " deep.

Weight: Net, 15 lbs. with plug-in.

Price: *hp* 3440A, (plug-in unit required), *hp* 3441A, *hp* 3442A: prices on request.

Data subject to change without notice.

428A,B CLIP-ON DC AMMETERS

Measure Without Interrupting Circuit, No Circuit Loading

Advantages:

Clips on, no circuit interruption
No circuit loading
Measure dc in the presence of ac
DC amplifier isolated from circuit being measured
Accessory probes increase versatility

Uses:

Computer testing: With quick clip-on convenience, current measurements can be made rapidly. This speed is especially helpful where multiple measurements are required.

Transistor circuit analysis: With virtually no loading of the circuit under test, *hp* 428's can usefully measure current even in a low impedance emitter circuit.

Combined measurements: The sum (or difference) of individual currents can be measured directly by clamping the probe around several wires.

Low frequency ac current measurements: For external metering or recorder operation a front panel output on the 428B provides a voltage proportional to the current being measured. Can be used as an isolated input dc current amplifier.

Special measurements: Large probe permits measurement on larger conductors; Magnetometer probe useful for studying magnetic fields.

With the *hp* 428A and 428B Clip-on DC Ammeters, direct current from 0.3 milliamperes to 10 amps can be measured without interrupting the circuits and without the error-producing loading of conventional methods. These ammeters can save many expensive engineering man hours, especially with the increased importance of current parameters in solid state circuitry.

For any measurement of dc within its range, simply clamp the jaws of the *hp* 428 around a wire and read!

This ease and speed of operation are unparalleled, especially for applications where many dc measurements must be made. Wide current range of the 428A or B will handle most signals directly. For even greater sensitivity, several loops may be put through the probe, increasing the sensitivity by the same factor as the number of loops.

The 428 is fast and accurate in circuits where conventional current-measuring devices would alter conditions so that readings would be meaningless or the circuit even inoperative.

In addition to making current measurements directly, the 428A and B are also valuable for measuring sums and differences of currents in separate wires. When the probe is clipped around two wires carrying current in the same direction, their sum is indicated on the meter; when one of the wires is reversed, their difference is measured. Thus, current balancing is possible by obtaining a zero difference reading.

Model 428B has three more ranges than the 428A and provides an output voltage proportional to the measured current which is useful for driving recorders or making low frequency (dc to 400 cps) current measurements. Thus, the 428B is a convenient, completely isolated dc to 400 cps current amplifier. With these two exceptions, the 428A and 428B are identical.

Specifications

Current Range: *hp* 428A: 3 ma to 1 ampere, full scale, 6 ranges; *hp* 428B: 1 ma to 10 amps, full scale, 9 ranges.

Accuracy: ± 0.1 ma $\pm 3\%$ of full scale.

Probe Inductance: Less than 0.5 μ h introduced into measured circuit.

Probe Induced Voltage: Less than 15 mv peak into measured circuit.

AC Rejection: AC with peak value less than full scale affects meter accuracy less than 2% at frequencies above 5 cycles (On 428B 10 amp range, ac is limited to 4 amps peak.)

Output: *hp* 428B - approx. 1.5 v @ 1 ma max. for full scale. Switch position provides 1 v output for full scale. Frequency response dc to 400 cps.

Probe Insulation: 300 volts, maximum.

Probe Tip Size: Approximately $\frac{1}{2}$ " x $\frac{21}{32}$ ", aperture diameter $\frac{5}{32}$ ".

Dimensions: $7\frac{1}{2}$ " wide, $11\frac{1}{2}$ " high, $14\frac{1}{4}$ " deep (cabinet); 19" wide, 7" high, 13" deep behind panel (rack mount).

Weight: Cabinet: Net 19 lbs. Shipping 24 lbs. rack mount: Net 24 lbs. Shipping 35 lbs.

Accessories Available: *hp* 3528A Large Aperture Current probe (with degausser), \$450; *hp* 3529A Magnetometer Probe, \$75.

Price: *hp* 428A, \$500 (cabinet); *hp* 428AR, \$505 (rack mount). *hp* 428B, \$600 (cabinet); *hp* 428BR, \$605 (rack mount).

Options: 01. *hp* 3528A Current Probe and degausser in lieu of standard probe, add \$375. 02. *hp* 3529A Magnetometer Probe in lieu of standard probe, no extra charge.

Data subject to change without notice.



Ⓔ 428A



Ⓔ 428B

Model 3528A Current Probe

This large aperture current probe permits the 428A and B to make measurements on any conductor up to 2-9/16" in diameter. It is useful for measuring common mode, ground and electrolysis currents in pipes, multi-conductor cables (including lead-sheathed), ground straps, even microwave waveguide. Current range of this large diameter probe is the same as the 428 with which it is used, and bandwidth with the 428B is dc to 300 cps. Accuracy is $\pm 1 \text{ ma} \pm 3\%$ of full scale when the probe is calibrated with the instrument ($\pm 5\%$ with any 428B). Inductance less than $3 \mu\text{h}$ is introduced into the measured circuit.



Ⓔ 3528A



Model 3529A Magnetometer Probe

The *hp* 3529A Magnetometer Probe is useful in applications where determination must be made of the direction or magnitude of a magnetic field. It is useful in applications ranging from acoustical transducer design to investigations involving the Zeeman effect. Conversion factor is 1:1, producing a reading on the 428 in milliamps which is directly equal to the measured field strength in milligauss. Range is 3 milligauss to 1 gauss with 428A and 1 milligauss to 10 gauss with the 428B. Bandwidth with the 428B is dc to 80 cps and accuracy is $\pm 3\%$ of full scale when the probe is calibrated with the instrument ($\pm 5\%$ with any 428).

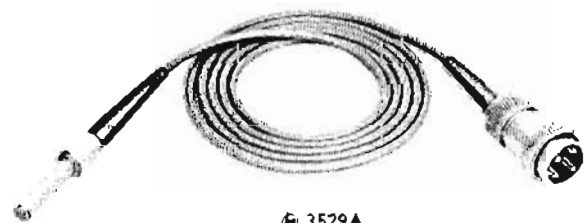

Ⓔ 3529A

456A AC CURRENT PROBE

Measures AC Current Without
Direct Connection to Wire

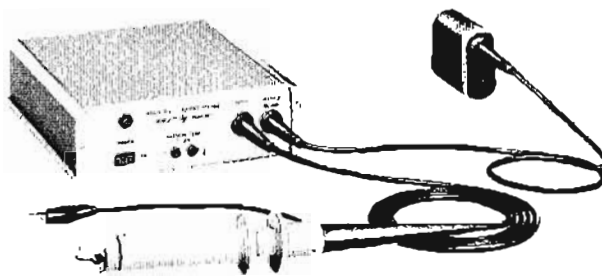

Ⓜ 456A shown with Ⓜ 400D

Specifications

- Sensitivity:** 1 mv/ma $\pm 1\%$ at 1 KC.
- Frequency Response:** $\pm 2\%$, 100 cps to 3 MC.
 $\pm 5\%$, 60 cps to 4 MC.
-3 db at 25 cps and greater than 20 MC.
- Pulse Response:** Rise time is < 20 nsec, sag $< 16\%/msec$.
- Maximum Input:** 1 amp rms; 1.5 amp peak. 100 ma above 5 MC.
- Effect of dc Current:** No appreciable effect on sensitivity and distortion from dc current up to 0.5 amp.
- Input Impedance:** (Impedance added in series with measured wire by probe.) Less than 50 milliohms in series with $0.05\mu h$. (This is approximately the inductance of $1\frac{1}{2}$ in. of hookup wire.)
- Probe Aperture:** $5/32$ " dia.
- Probe Shunt Capacity:** Approximately 4 pf added from wire to ground.
- Distortion at 1 KC:** For $\frac{1}{2}$ amp input at least 50 db down.
For 10 ma input at least 70 db down.
- Equivalent Input Noise:** $< 50 \mu a$ rms (100 μa when ac powered).
- Output Impedance:** 220 ohms at 1 KC. Approximately +1 v dc component. Should work into load of not less than 100,000 ohms shunted by approximately 25 pf.
- Power:** Two Mallory Battery Co. TR 233R and one TR 234 batteries (Ⓜ # 1420-0005 and 1420-0006). Battery life approximately 400 hours. AC power supply optional at extra cost, 115 or 230 v $\pm 10\%$ 50 to 1,000 cps, approximately 1 watt.
- Weight:** Net 3 lbs. Shipping 4 lbs.
- Dimensions:** 5" wide, 6" deep, $1\frac{1}{2}$ " high. Probe cable is 5 ft. long; 2 ft. output cable terminated with dual banana plug.
- Accessories Available:** Ⓜ 11028A 100:1 Current Divider, \$32.00;
Ⓜ 456-11A AC Supply for field installation, \$40.00.
- Price:** Ⓜ 456A with batteries, \$190.00.
- Option:** 01. AC supply installed in lieu of batteries, add \$20.00.

Now your conventional voltmeter or oscilloscope can measure current quickly and dependably—*without direct connection to the circuit under test or any appreciable loading to the test circuit.*

The Ⓜ 456A AC Current Probe clamps *around* the current-carrying wire, and provides a voltage output you read on a voltmeter or scope. Model 456A's 1 ma to 1 mv conversion permits direct readings up to 1 ampere rms. Model 456A permits measurement of ac in logic circuits, transistors and vacuum tubes since even 0.5 ampere of dc has no appreciable effect on operation. The instrument also makes possible viewing on oscilloscopes complex current waveforms with rise times up to 20 nsec, or current signals ranging from 1 ma rms to 1 ampere rms.

The instrument can be relied upon for accurate measurements since it is virtually unaffected by stray fields or wire position in the aperture of the probe.

Data subject to change without notice.

VOLTMETER ACCESSORIES

Extend the usefulness of your present $\text{\textcircled{P}}$ voltmeters with these precision built $\text{\textcircled{P}}$ accessories. Make fast, accurate measurements far beyond the original range of your instruments.

In addition to the time-saving accessories shown here, $\text{\textcircled{P}}$ 1110A Current Probe (use with your ac voltmeter or scope to measure current) and $\text{\textcircled{P}}$ 10025A Low Frequency Probe are offered. For details, see pages 54-55.

$\text{\textcircled{P}}$ 11039A Capacitive Voltage Divider

For $\text{\textcircled{P}}$ 400 and 410 series voltmeters. Safely measures power voltages to 25 kv. Accuracy $\pm 3\%$. Division ratio, 1,000:1. Input capacity 15 pf ± 1 . Maximum voltage ratings (sea level) 60 cps, 25 kv; 100 KC, 22 kv; 1 MC, 20 kv; 10 MC, 15 kv; 20 MC, 7 kv. Usable for dielectric heating, power and ultra-sonic voltages. Price, \$150.00.

$\text{\textcircled{P}}$ 11018A Adapter: Connects 410 to shielded connector. \$25.00.

$\text{\textcircled{P}}$ 11040A Capacitive Voltage Divider

For $\text{\textcircled{P}}$ 410 Voltmeters. Increases range so transmitter voltages can be measured quickly, easily. Accuracy $\pm 1\%$. Division ratio, 100:1. Input capacity approximately 2 pf. Maximum voltage 2,000 v, decreasing to 100 v at 400 MC. For frequencies 10 KC and above. \$30.00.

$\text{\textcircled{P}}$ 11041A Capacitive Voltage Divider

For $\text{\textcircled{P}}$ 400 series Voltmeters. Safely measure power line, audio, ultrasonic and rf voltages. Accuracy $\pm 3\%$. Division



$\text{\textcircled{P}}$ 11040A
Formerly 453A



$\text{\textcircled{P}}$ 11039A
Formerly 452A

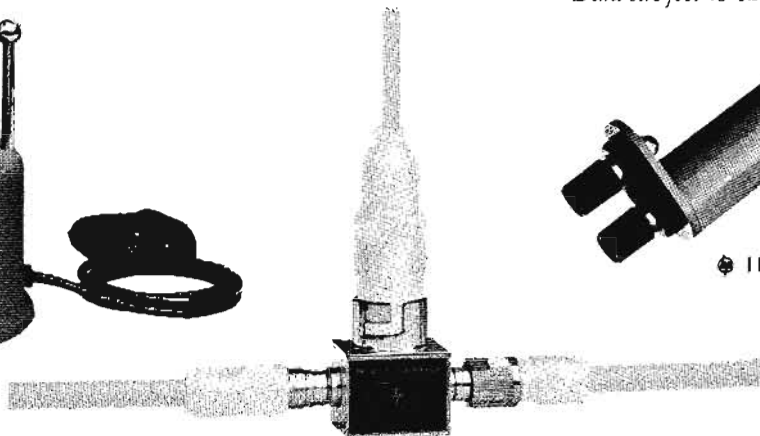

$\text{\textcircled{P}}$ 11042A
Formerly 455A



$\text{\textcircled{P}}$ 11018A

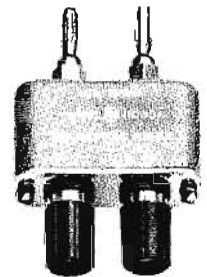

$\text{\textcircled{P}}$ 11030A

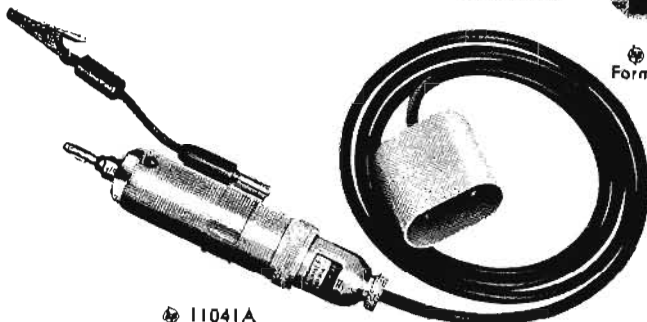

$\text{\textcircled{P}}$ 11041A
Formerly 454A



$\text{\textcircled{P}}$ 11043A
Formerly 458A

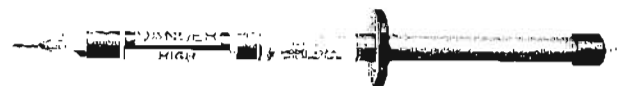

$\text{\textcircled{P}}$ 11044A
Formerly 459A

ratio, 100:1. Input impedance 50 megohms, resistive shunted with 2.75 pf capacity. Maximum voltage, 1,500 v. Price, \$50.00.

$\text{\textcircled{P}}$ 11042A Probe Coaxial "T" Connector

For $\text{\textcircled{P}}$ 410 Voltmeters. Measures voltages between center conductor and sheath of 50-ohm transmission line. Maximum standing wave ratio 1.1 at 500 MC, 1.2 at 1,000 MC. Male and female type "N" fittings. Price \$40.00.

$\text{\textcircled{P}}$ 11043A Probe Coaxial "N" Connector

For $\text{\textcircled{P}}$ 410 Voltmeters. Measures at open end of 50-ohm transmission line. (No terminating resistor.) Has male type "N" fitting. Price, \$30.00.

$\text{\textcircled{P}}$ 11044A DC Voltage Divider

For $\text{\textcircled{P}}$ 410 Voltmeters. Gives maximum safety and convenience for measuring high voltages as in television receivers, etc. Accuracy $\pm 5\%$. Division ratio 100:1. Input impedance 12,000 megohms. Maximum voltage 30 kv. Maximum current drain 2.5 microamperes. Price, \$50.00.

$\text{\textcircled{P}}$ Shunt Resistors

For $\text{\textcircled{P}}$ 400 series Voltmeters, to measure currents as small as 1 μa full scale. Accuracy $\pm 1\%$ to 100 KC, $\pm 5\%$ to 4 MC; 11029A, $\pm 5\%$ to 1 MC). Maximum power dissipation 1 watt.

INSTRUMENT	MAX. CURRENT	MAX. VOLTAGE	VALUE	PRICE
$\text{\textcircled{P}}$ 11029A	3 a	0.3 v	0.1 Ω	\$35.00
$\text{\textcircled{P}}$ 11030A	1 a	1.0 v	1 Ω	20.00
$\text{\textcircled{P}}$ 11031A	0.3 a	3.0 v	10 Ω	20.00
$\text{\textcircled{P}}$ 11032A	0.1 a	10.0 v	100 Ω	20.00
$\text{\textcircled{P}}$ 11033A	40 ma	25.0 v	600 Ω	20.00
$\text{\textcircled{P}}$ 11034A	30 ma	30.0 v	1,000 Ω	20.00

Data subject to change without notice.

VTVM CALIBRATION SYSTEM

200SR, 738AR, 739AR

Calibrate for Frequency Response, Voltage Accuracy

This accurate *hp* system calibrates vacuum tube voltmeters and oscilloscopes for both frequency response and voltage accuracy. The system combines three moderately priced basic *hp* instruments that calibrate for voltage levels from 300 microvolts to 300 volts in precise pre-selected steps and calibrate for frequency response from 5 cps to 10 mc.

The three instruments are available individually (*hp* 738AR Voltmeter Calibrator; *hp* 739AR Frequency Response Test Set; *hp* 200SR Oscillator) or in a single enclosure provided with rear access door and power strip.

The 738AR is a highly stable precision voltage source, drift less than 0.1% per week for dc voltage, less than 0.25% per week for ac voltage. The 739AR provides a convenient constant-amplitude reference voltage of a variable frequency, 300 kc to 10 mc. The 200SR combines with the 739AR to extend the range to frequencies as low as 5 cps.

Specifications

738AR Voltmeter Calibrator

Voltage Range: 300 μ v to 300 v, dc or ac (rms and peak-peak, 400 cps).

Levels: Calibration voltage 300 μ v to 300 v in steps of 0.3, 0.5, 1, 2 and 3 volts with multipliers of 0.001, 0.01, 0.1, 1, 10 and 100.

Tracking voltage 0.1 to 1 v in 0.1 volt steps and 0 to 3 v in 0.5 volt steps.

Accuracy: 300 v working voltage into attenuator, accurate within 0.1% dc and 0.25% ac, after a 30-minute warm-up.

Long-term Stability: Less than 0.1% dc drift per week, less than 0.25% ac drift per week.

Attenuator Accuracy: Within $\pm 0.1\%$ or $\pm 5 \mu$ v, whichever is larger.

Power: 115 or 230 v $\pm 10\%$, 50 to 60 cps, 350 watts.

Dimensions: 19" wide, 7" high, 15 $\frac{3}{4}$ " deep behind panel.

Weight: Net 38 lbs. Shipping 53 lbs.

Price: 738AR, \$950 (rack mount).

739AR Frequency Response Test Set

Frequency Range: 300 kc to 10 mc in 3 ranges (5 cps to 10 mc with *hp* 200SR Oscillator).

Frequency Response of Monitoring Circuit: Flat within $\pm 0.5\%$ from 10 cps to 5 mc; within $\pm 0.5\%$, -1.5% , 5 cps to 10 mc. Monitoring circuit is average reading.

Power: 115 or 230 v $\pm 10\%$, 50 to 1000 cps, 30 watts.

Dimensions: 19" wide, 7" high, 8 $\frac{3}{4}$ " deep behind panel.

Weight: Net 14 lbs. Shipping 24 lbs.

Price: 739AR, \$600 (rack mount).

200SR Oscillator

Frequency Range: 5 cps to 600 kc in 5 ranges.

Output: At least 3 v rms into 50 ohms.

Dial Accuracy: $\pm 2\%$.

Frequency Response: ± 1 db, 1000 cps reference.

Power: 115 or 230 v $\pm 10\%$, 50 to 1000 cps, 75 watts.

Dimensions: 19" wide, 7" high, 13 $\frac{1}{8}$ " deep behind panel.

Weight: Net 23 lbs. Shipping 27 lbs., cabinet. Net 25 lbs. Shipping 37 lbs., rack mount.

Price: 200SR, \$230 (rack mount); 200S, \$225 (cabinet).

NOTE: All three instruments are available in cabinet with single power cord and plug strip. Specify K02 738A, \$2020.

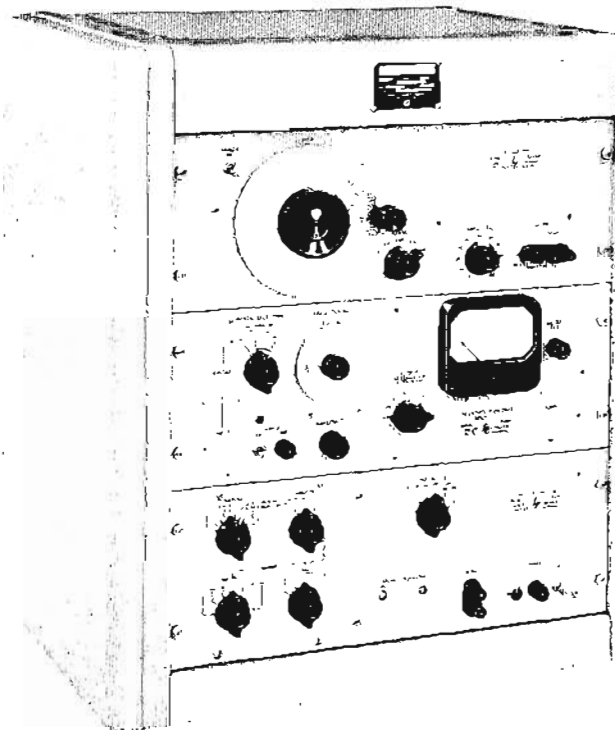

Top to bottom,  200SR,  739AR,  738AR

hp ACCESSORIES



10111A



10110A

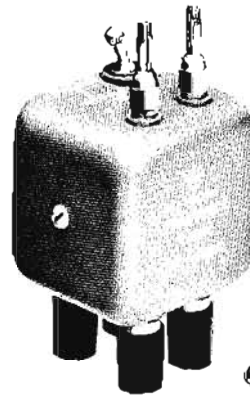

11004A

hp 10110A, 10111A BNC-to-Binding Post Adapters (formerly AC-76A,B). These adapters mate with a BNC or binding post receptacle, respectively, and provide either binding post or BNC output connectors. The 10110A is a BNC male to binding post adapter; the 10111A is a BNC female to banana plug adapter. Spacing between binding posts is $\frac{3}{4}$ ". hp 10110A, \$5; hp 10111A, \$7.

hp 11004A, 11005A Line Matching Transformers (formerly AC-60A,B). Model 11004A is designed to connect a balanced system to hp 200 series audio oscillators, 400 series voltmeters, or similar equipment, for carrier current or other measurements between 5 and 600 kc. With hp 200CD it provides fully balanced 135- or 600-ohm output with attenuator in use. With hp 400 series it provides voltage measurements on either a 135- or 600-ohm balanced line without grounding one side and permits bridging or terminated voltage measurements on both 135- and 600-ohm lines. Maximum level + 22 dbm. Shipping weight 2 lbs. Price, \$60. Model 11005A is similar to the hp 11004A except that it is for use in audio systems—designed specifically for connecting hp 330 Noise and Distortion Analyzers to a balanced line. Frequency range is 20 cps to 45 kc; maximum level is + 15 dbm. Shipping weight 6 lbs. Price, \$80.

hp 10501A Cable Assembly (formerly AC-16D). 44" of 50-ohm coaxial cable terminated on one end only with UG-88C/U BNC male connector; \$3.50 each.

hp 10502A Cable Assembly (formerly AC-16E). 9" of 50-ohm coaxial cable terminated on both ends with UG-88C/U BNC male connectors; \$5.50 each.

hp 10503A Cable Assembly (formerly AC-16K). 4' of 50-ohm coaxial cable terminated on both ends with UG-88C/U BNC male connectors; \$6.50 each.

hp 11000A Cable Assembly (formerly AC-16A). Dual banana plugs terminate a section of 50-ohm cable, 44" overall. Plugs for binding posts spaced $\frac{3}{4}$ "; \$4.50 each.

hp 11001A Cable Assembly (formerly AC-16B). Identical with 11000A except dual banana plug on one end and UG-88C/U BNC male on the other; \$5.50 each.

hp 11002A Test Leads (formerly AC-16S). Dual banana plugs to alligator clips, 5' long; \$7.50 each.

hp 11003A Test Leads (formerly AC-16T). Dual banana plug to probe and alligator clip, 5' long; \$10 each.

hp 11035A Cable Assembly (formerly AC-16Z). 12" of 50-ohm coaxial cable terminated on one end with a dual banana plug and on the other with a UG-88C/U BNC male connector; \$5.50 each.

hp 11500A Cable Assembly (formerly AC-16Q). 6' of specially treated 50-ohm coaxial cable terminated on both ends with UG-21D/U Type N male connectors; \$15 each.

hp 11501A Cable Assembly (formerly AC-16C). 6' of 50-ohm coaxial cable terminated with UG-21D/U Type N male and UG-23D/U Type N female; \$15 each.

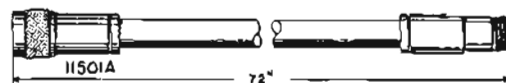
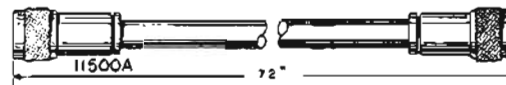
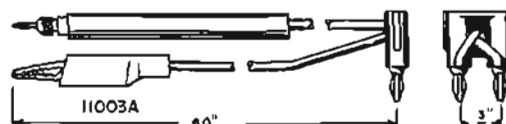
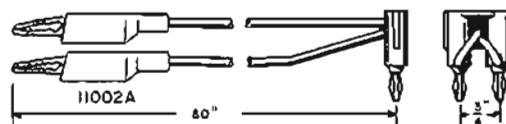
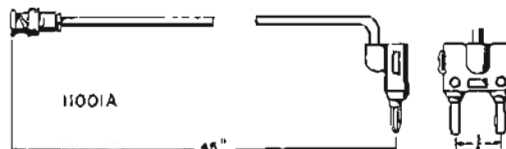
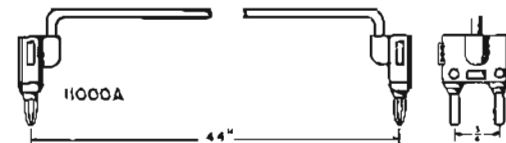
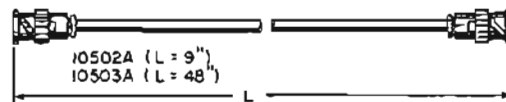

hp AMPLIFIERS

466A AC Amplifier

Model 466A AC Amplifier is a highly stable, low distortion, wide range amplifier offering 20 or 40 db gain to increase sensitivity of oscilloscopes or voltmeters by 10 or 100. Flat frequency response renders the instrument appropriate for audio, ultrasonic or low rf measuring.

The 466A is powered by ac line voltage, or by batteries providing approximately 150 hours of hum-free service. Its light weight and small size recommend it for field application.

Specifications

Gain: 20 db (x10) or 40 db (x100) \pm 0.2 db at 1,000 cps.

Frequency Response: \pm 0.5 db, 10 cps to 1 MC down 3 db; or less at 5 cps and 2 MC.

Output Voltage: 1.5 v rms across 1,500 ohms.

Output Current: 1 ma rms maximum.

Noise: 75 μ v referred to input, 100,000 ohm source.

Impedance: Input, 1 megohm, 25 pf shunt; output, approximately 50 ohms in series with 100 μ f.

Distortion: Less than 1%, 10 cps to 100 KC; less than 5% to 1 MC.

Power: 115/230 v \pm 10%, 50 to 1,000 cps, approximately 1 watt (supply normally furnished). Battery operation optional: radio type mercury batteries, TR234 or equivalent, 3 required (hp #1420-0006). Battery life approximately 150 hours.

Size: 6 $\frac{1}{4}$ " wide, 4" high, 6 $\frac{1}{4}$ " deep. Weight Net 3 lbs. Shipping 7 lbs.

Price: 466A, \$165.00, ac operation.

Option: 01. Batteries in lieu of ac supply, less \$15.00.

Data subject to change without notice.

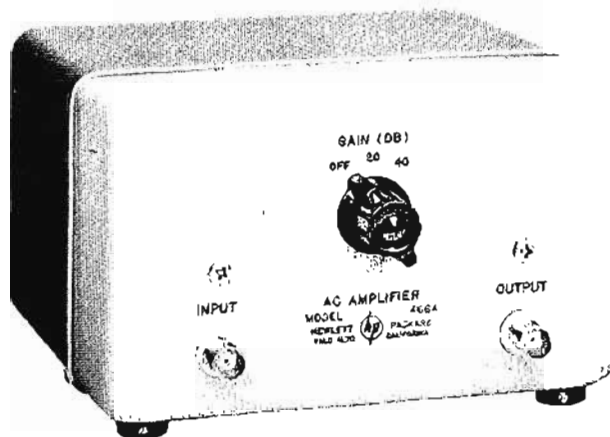

466A

450A Stabilized Amplifier

Model 450A is a general-purpose ac-powered amplifier offering a highly stable 20 or 40 db gain at any frequency from 10 cps to 1 MC. The instrument is resistance coupled, avoiding peaking or compensating networks. Optimum performance is obtained by clean, straightforward circuitry plus inverse feedback. Phase shift is negligible, there are no spurious oscillations or resonances, and hum is minimized by using a dc filament supply for input amplifier tubes.

Specifications

Gain: 20 db (x10) or 40 db (x100) \pm 1/8 db at 1,000 cps.

Frequency Response: 40 db gain: \pm 1/2 db, 10 cps to 1 MC; \pm 1 db, 5 cps to 2 MC.

20 db gain: \pm 1/2 db, 5 cps to 1 MC; \pm 1 db, 2 cps to 1.2 MC.

Stability: \pm 2%, includes line voltage variation 115 or 230 v \pm 10%.

Impedance: Input, 1 megohm, 15 pf shunt. Output, less than 150 ohms.

Distortion: Less than 1%, 2 cps to 100 KC; approximately 2% above 100 KC.

Output: 10 v max. into 3,000 ohm or greater load.

Noise Referred to Input: 40 db gain, 40 μ v; 20 db gain, 250 μ v.

Power: 115 or 230 v \pm 10%, 50 to 1,000 cps, 50 watts.

Size: Cabinet: 8 $\frac{5}{8}$ " wide, 5 $\frac{1}{2}$ " high, 10 $\frac{3}{4}$ " deep. Weight, 10 lbs. Rack Mount: 19" wide, 5 $\frac{1}{4}$ " high, 10 $\frac{5}{8}$ " deep behind panel. Weight: Net 11 lbs. Shipping 24 lbs.

Price: 450A, \$160.00 (cabinet); 450AR, \$165.00 (rack mount).

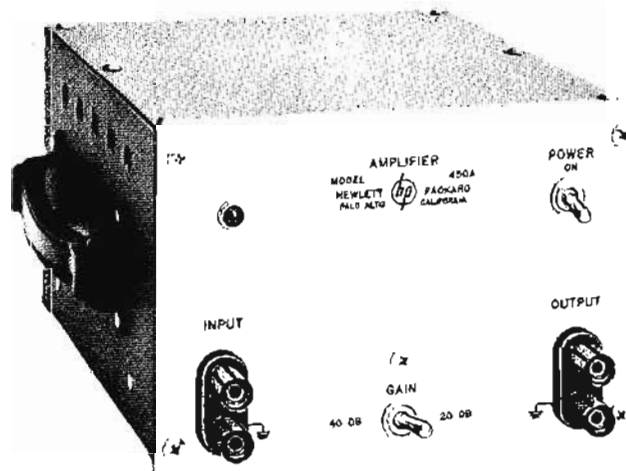

450A

hp 460AR, BR WIDE-BAND AMPLIFIERS

Wide-Band, Distortion-Free, Fast-Pulse Amplifiers

Model 460 Amplifiers make it possible for you to obtain at moderate cost true amplification of fast pulses at power levels sufficient to operate scalars, counting meters and cathode ray tubes.

The hp 460AR Wide-Band Amplifier is used fundamentally to provide voltage gain (approximately 20 db). Its companion equipment, hp 460BR, is designed as a terminal amplifier to give maximum voltage or power output. The amplifier's short rise time of 3 nsec, combined with zero overshoot, insures distortion-free amplification of pulses faster than 10 nsec. The hp 460BR cascaded with 460AR provides linear amplification of 16 volts peak output, and, with two 460BR's, pulse amplification of 110 volts open circuit.

This unusual combination gives maximum usefulness for fast-pulse nuclear radiation problems, television, vhf, uhf or shf work. It also means the bandwidth of your standard oscilloscope can be increased to over 100 mc, and voltmeter sensitivity multiplied by 10. In cascade or singly, the amplifiers offer further convenience as general-duty, wide-band instruments for all types of laboratory problems.

Specifications

460AR

Frequency Response: *High:* Closely matches Gaussian curve, into 200-ohm resistive load. 3 db point is 120 mc. *Low:* Off approx. 3 db at 20 kc, matched load. Off approx. 3 db at 3 kc, open circuit. With hp 410B and 11011A, ± 1 db, 200 kc to 200 mc.
Rise Time: 3 nsec.
Gain: Nominally 20 db into 200-ohm load. Control range, 6 db.
Sine Output: Approx. 8 v peak open circuit. < 5% distortion.
Maximum Pulse Output: +8 v (+ input), -20 v (- input) unloaded; +3.2 v (+ input), -8 v (- input) loaded.
Impedance: 200 ohms input; 300 ohms output.

Dimensions: 19" wide, 5 $\frac{1}{4}$ " high, 7" deep.
Weight: Net, 12 lbs. Shipping, 18 lbs.
Price: hp 460AR, \$225.

460BR

(Same as 460AR except as follows:)

Gain: Nominally 15 db into 200-ohm load.
Sine Output: Approx. 8 v peak, 200-ohm load; 16 v peak, open circuit.
Maximum Pulse Output: +16 v (- input), -110 v (+ input) unloaded; +8 v (- input), -60 v (+ input) loaded. (+8 v input required for -110 v output.) Linear: +16 v (- input), -16 v (+ input) unloaded; +8 v (- input), -8 v (+ input) loaded.
Duty Cycle: 5%.
Impedance: 200 ohms, input and output.
Price: hp 460BR, \$275.

Accessories

11006A Patch Cord—200 ohms, 2' long, \$22.50.
11007A Patch Cord—200 ohms, 6' long, \$31.50.
11008A Panel Jack—For 200-ohm cables, low capacitance, \$5.
11009A Cable Plug—For 200-ohm systems, \$5.
11010A 50-Ohm Adapter—Type N to hp 460, 50-ohm termination, \$17.50.
11011A Adapter—Bayonet sleeve for connecting hp 410B vtvm to output of 460A amplifiers, \$40.
11012A Connector Sleeve—Joins two 11009A Cable Plugs, \$7.50.
11013A Adapter—For connecting to 5 XP CRT, \$9.
11015A Adapter—Type N to hp 460, 200-ohm termination, \$17.50.
11016A Adapter—Type N to hp 460, no termination, \$15.
11017A Adapter—410B vtvm to 460, 200-ohm termination, \$35.
11019A Adapter—Connects to 150A, AR oscilloscope plates, \$35.
8120-0014 Cable — 200-ohm cable, specify length. Per foot, \$2.25.

Data subject to change without notice.



460AR

SANBORN MODEL 860-4000 FIFO DIFFERENTIAL DC AMPLIFIER

Amplify High Frequency Signals From Wideband Transducers

Advantages:

- Isolated, floating, guarded input
- Isolated, floating output
- Less than 1 msec recovery from 20 v overload DC to 10 kc bandwidth
- Gain of 1000
- All solid state

The Sanborn FIFO (floating input — floating output) Model 860-4000 is a solid state dc amplifier offering a 10 kc bandwidth and designed especially for amplifying high frequency signals from wideband transducers. It is particularly useful for extracting low level signals from large amounts of noise. It offers a gain of up to 1000.

A single FIFO used with an input scanner can amplify data from many transducers, or the outputs of any number of FIFO's may be sampled. A Model 860-4000P (grounded output isolated from the input) is available to drive high frequency galvanometers and has an output capability of ± 10 volts at ± 100 ma. Both models have a high common mode rejection ratio and an exceptional recovery time.

The FIFO amplifier is available in a portable case with individual power supply, and two channels with individual power supplies are available on a 3 1/2" panel for rack mounting. Eight amplifiers can be mounted in a 7" x 19" space with a Sanborn Model 868-500AF 8-Channel Power Supply. Each amplifier weighs only four pounds and requires only 2" x 7" of front panel space.

Specifications

- Gain: 1000, 500, 200, 100 and 50; Smooth gain control.
- Gain Stability: $\pm 0.05\%$ at dc for 40 hours; $\pm 0.01\%$ change/ $^{\circ}$ C.
- Gain Accuracy: $\pm 0.5\%$ at dc; $\pm 0.1\%$ available on special order.
- Gain Trim: Can be used to trim any one gain to within $\pm 0.03\%$.
- Input: Isolated from ground and from output.
- Input Impedance: 100 megohms minimum at dc, 0.001 μ f shunt.
- Common Mode Rejection: (1000 ohms in either input lead): 160 db at dc, 120 db at 60 cps, 100 db at 400 cps, ± 300 v max.
- Common Mode Tolerance: ± 300 v dc or peak ac.
- Bandwidth: DC to $\pm 1\%$ at 500 cps; $\pm 5\%$ at 5 kc; -3 db at 10 kc.
- Rise Time: For step input, 250 μ sec. to 99.9% of steady state value.
- Output: Isolated from input and ground for 860-4000; grounded output isolated from input for 860-4000P.
- Output Impedance: 60 ohms for 860-4000, 0.5 ohms or less for 860-4000P (power output is at ground potential).
- Output Capability: 860-4000: ± 10 v at 10 ma into 1000 ohms, amplifier must be loaded with 1000 ohms, $\pm 5\%$ in order to provide specified gain. 860-4000P: ± 10 v at 100 ma.
- Linearity: $\pm 0.1\%$ of full scale at dc; full scale is 10 v.
- Noise (Referred to input at gain of 1000): 1 μ v p-p, dc to 3 cps; 3 μ v p-p, dc to 20 cps; 10 μ v, p-p, dc to 200 cps; 3 μ v rms, dc to 1 kc; 5 μ v rms, dc to 10 kc; 7 μ v rms, dc to 30 kc.
- Drift: ± 2 μ v referred to input $\pm 0.01\%$ of full scale at the output of a constant ambient temperature for 40 hours.
- Temperature Coefficient of Drift: 860-4000: ± 1 μ v/ $^{\circ}$ C referred to input, $\pm 0.002\%$ of full scale/ $^{\circ}$ C at the output. 860-4000P: ± 1 μ v/ $^{\circ}$ C referred to input, $\pm 0.01\%$ of full scale/ $^{\circ}$ C at output.
- Overload Recovery: For 500% overload, 300 μ sec to 1% of full scale out; for 20 v overload, 500 μ sec to 10% of full scale out, 1 msec to 1% of full scale out.
- Weight: Net 4 lbs.
- Power: 115 v $\pm 10\%$, 50 to 400 cps, 14 watts.
- Prices: Model 860-4000, \$825. Model 860-4000P Amplifier, \$900. Model 868-500AF Eight-Channel Power Supply, \$650. Model 860-500F Single-Channel Power Supply, \$250. Model 860-1400 Portable Case, \$75. Model 860-200 Two-Channel Module (1 9/8" deep), \$100*. Model 860-200A Two-Channel Module (flush front), \$75.*

*Order horizontal lettering on amplifiers.

Data subject to change without notice.

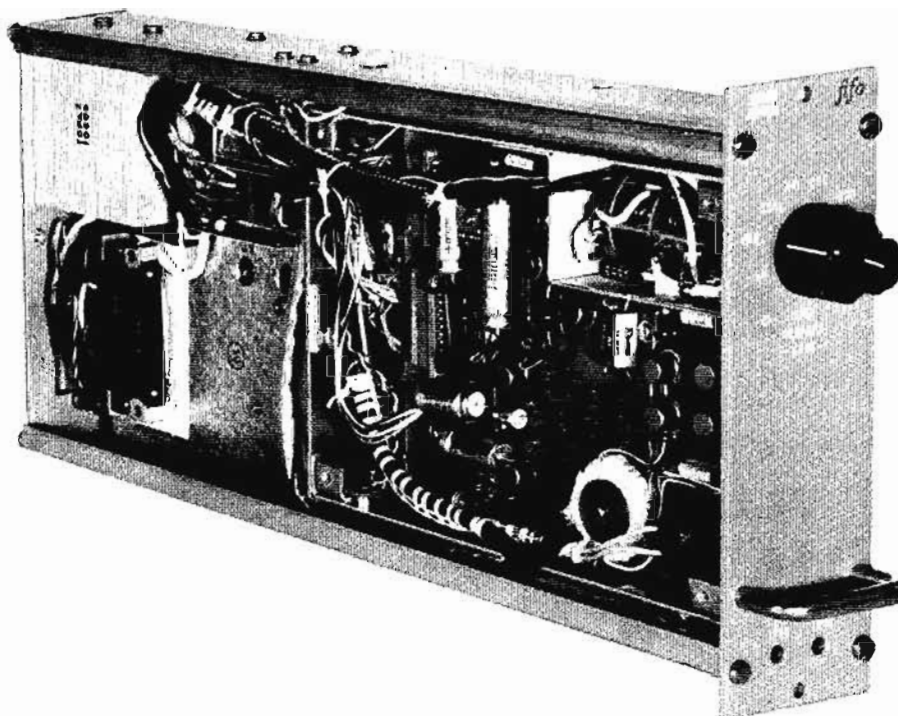

NEW IN THIS CATALOG

SANBORN MODEL 860-4200 FLOATING WIDEBAND DC AMPLIFIER

For High Precision
Data Reduction From
Resistance Bridge Transducers,
Thermocouples

Advantages:

- Maximum gain of 1000
- Linearity $\pm 0.01\%$ of full scale
- DC to 50 kc bandwidth
- All solid state circuitry
- Internal power supply

The Sanborn Data Amplifier Model 860-4200 is a fully transistorized 3-terminal potentiometric input dc amplifier featuring a dc to 50 kc bandwidth. The amplifier provides high precision data acquisition from thermocouples, strain gage bridges and other resistance bridge transducers. Typical outputs for the amplifier include digital voltmeters, tape recorders, optical recorders, oscilloscopes and other readout devices. The amplifier is available in a portable case or in a two-hole module with a $3\frac{1}{2}'' \times 19''$ panel for rack mounting. Each preamplifier weighs only 4 pounds and requires $2'' \times 7''$ of front panel space. The preamplifier includes an internal power supply.

Specifications

- Gain: 1000, 500, 200, 100, 50, 20 and 10. Does not invert phase.
- Gain Accuracy: Standard $\pm 0.25\%$ at dc.
- Gain Vernier: Covers any gain setting between fixed steps. Can be switched out.
- Gain Stability: $\pm 0.01\%$ at dc at constant ambient temperature for 40 hours.
- Gain Trim: Set any gain step to at least $\pm 0.02\%$ of correct value.
- Input Impedance: 100 megohms at dc in parallel with no more than $0.001 \mu f$.
- Isolation Between Input and Case: 500 megohms at 60 cps.
- Bandwidth: dc to 50 kc within 3 db.
- Output Impedance: Less than 0.2 ohms.
- Output Capability: ± 10 volts and ± 100 ma.
- Noise: $7 \mu v$ rms referred to the input (50 kc bandwidth).
- Drift: $\pm 0.02\%$ of full scale at the output at constant ambient temperature for 40 hours. $\pm 0.002\%$ of full scale at the output/ $^{\circ}C$.
- Non-Linearity: No more than $\pm 0.01\%$ of 10 volt output.
- Zero Trim: ± 50 mv at the output.
- Power: 115 v $\pm 10\%$, 50 to 400 cps, 5 watts.
- Dimensions: $2''$ wide, $7''$ high, $20\text{-}5/16''$ deep.
- Weight: Net 4 lbs.
- Prices: Model 860-4200 Floating Wide Band DC Amplifier, \$650; Model 860-1400 Portable Case, \$75; Model 860-200 Two-Channel Module, \$100; Model 860-200A Two-Channel Module (flush front), \$75.

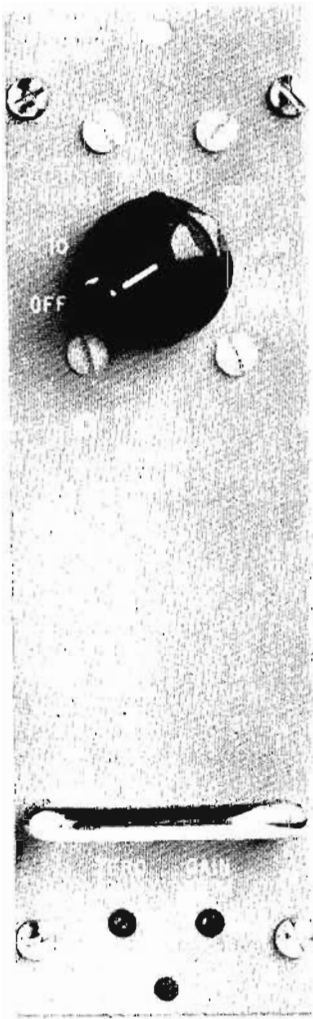

NEW IN THIS
CATALOG

Data subject to change without notice.

SANBORN MODEL 860-4300 NARROW-BAND DIFFERENTIAL DC AMPLIFIER

Low Noise Amplifier for Use With Thermocouples, Strain Gages, Similar Devices

Advantages:

- Isolated, floating, guarded input
- Isolated, floating output
- Maximum gain of 1000
- Linearity $\pm 0.05\%$ of full scale
- All solid state circuitry
- Overload protection

The Sanborn Data Amplifier Model 860-4300 is designed to amplify signals from thermocouples, strain gages and other resistance bridge transducers. This completely transistorized, low noise amplifier successfully combines a floating input which allows measurement of low level signals even though complicated by ground loops, high gain and zero stability, and a floating output (isolated from input) which eliminates ground loop problems with terminal equipment.

Typical outputs for the amplifier include digital voltmeters, tape recorders, oscillographs, oscilloscopes and other readout devices.

The amplifier is available in a portable case with individual power supply. Two channels with individual power supplies are available on a $3\frac{1}{2}$ " x 19" panel for rack mounting, or you can mount eight amplifiers in a 7" x 19" rack with a Sanborn Model 868-500A eight-channel power supply at its rear. Sixty-four amplifiers, a blower unit and a master power panel take only $66\frac{1}{2}$ " of front panel space. Each amplifier weighs only 6 pounds and requires only 2" x 7" of front panel space.

Specifications *

- Gain: 1000, 500, 200, 100, 50, 20 and 10.
 - Gain Accuracy: $\pm 0.5\%$ at dc.
 - Gain Stability: $\pm 0.05\%$ at dc with constant ambient temperature for 40 hours; $\pm 0.005\%$ change/ $^{\circ}\text{C}$.
 - Gain Trim: Can be used to trim any one gain to within $\pm 0.02\%$ covers $\pm 3\%$ range.
 - Input: Isolated from ground and from output.
 - Input Impedance: 500K ohms minimum.
 - Common Mode Rejection: (For 1000 ohms in either input lead); 130 db at 60 cps; 160 db at dc.
 - Common Mode Tolerance: 220 v rms.
 - Bandwidth: dc to $\pm 1\%$ at 30 cps; dc to 3 db down at 100 cps.
 - Rise Time: 20 ms to 0.1% of final value for a step input.
 - Output: Isolated from input and from ground.
 - Output Impedance: 75 ohms.
 - Output Capability: ± 5 v at 2.5 ma.
 - Linearity: $\pm 0.05\%$ of 5 v output.
 - Drift: ± 2 μv at constant ambient temperature for 40 hours; ± 0.2 $\mu\text{v}/^{\circ}\text{C}$ referred to input.
 - Zero Trim: ± 50 mv of output.
 - Overload Recovery: 200 ms from ± 10 v overload. Differential input voltages of ± 60 v peak will not damage input circuitry or chopper.
 - Noise: 3 μv p-p referred to input for gain of 1000 (wide band).
 - Peak Ripple Due to Signal: 0.04% of signal.
 - Dimensions: 2" wide, 7" high, 14.9" deep.
 - Weight: Net 4 lbs.
 - Power Requirements: 115 v $\pm 10\%$, 50 to 400 cps 14 watts.
 - Prices: Model 860-4300 Narrow Band DC Amplifier, \$425.
Model 868-500A Eight Channel Power Supply and Frame, \$600.
Model 860-500 Single-Channel Power Supply, \$210.
Model 860-1400 Portable Case, \$75.
Model 860-200 Two-Channel Module, \$100.
Model 860-200A Two-Channel Module (flush front), \$75.
- * Specifications are for source impedances to 1000 ohms and ambient temperatures from 15 $^{\circ}\text{C}$ to 45 $^{\circ}\text{C}$. Rate of ambient temperature variation not to exceed 10 $^{\circ}\text{C}/\text{hour}$. Amplifier will operate with higher source impedances. Performance degradation will be in gain accuracy, noise specification and temperature coefficient of gain. Amplifier will operate in ambients to 60 $^{\circ}\text{C}$. In range above 45 $^{\circ}\text{C}$, temperature coefficient of gain will increase to $\pm 0.01\%/^{\circ}\text{C}$ when used with source from 0 to 1000 ohms.

Data subject to change without notice.

NEW IN THIS
CATALOG

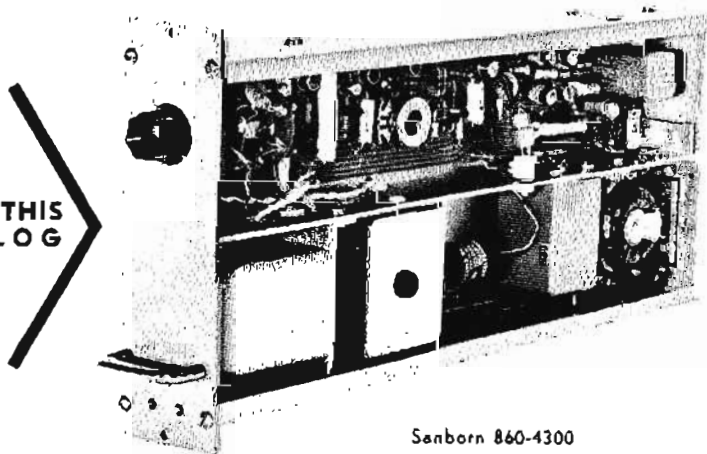

Sanborn 860-4300

DYMEC MODEL DY-2460A SOLID STATE DC AMPLIFIER

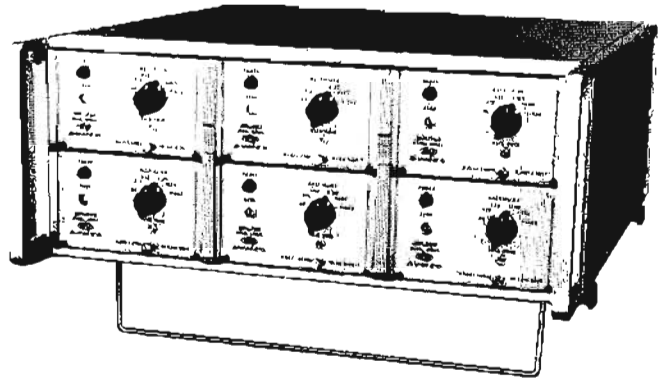

Advantages:

- Ideal for amplifying low-level signals
- Fast settling time, fast overload recovery
- Low zero drift, low noise
- Plug-in versatility

The completely solid-state DY-2460A Amplifier, moderately priced to make it an exceptional value, achieves extremely high reliability on low-level measurements through a specially designed photoconductive chopper and all-transistor circuitry.

Interchangeable plug-in units contain gain control circuits. Available are plug-ins with: five fixed gains (1 to 1000); four fixed decade gains (1 to 1000) and multi-turn vernier; patch panel to allow use as versatile summing amplifier, integrator and differentiator (input, output, summing point and feedback circuits brought out to front panel); plus-one gain configuration for high input impedance (input resistance greater than 10^{10} ohms, high gain accuracy).

Specifications DY-2460A Amplifier (without plug-in)

Open-Loop Gain (Inverting): (Minimum values with load impedance $> 1K$.) 5×10^4 at dc; 7×10^4 at 40 cps; 1 at 1 mc.
Open-Loop Input Impedance: (Minimum values. Shunt capacitance 60 pf max.) 1M at dc; 150K at 1 kc.
Open-Loop Output Impedance: 10 ohms max., dc to 10 kc; 50 ohms max., 10 kc to 1 mc.
Input Noise: (Referred to summing point, $< 100K$ to ground.) $4 \mu v$ p-p max., 0 to 1 cps; $10 \mu v$ rms max., 0 to 1 kc.
Zero Drift: (Referred to summing point, $< 100K$ to ground; [2-hr. warmup]). Constant temp., $1 \mu v$ /week max.; temp. coeff., $0.5 \mu v/^\circ C$ max.
Zero Adjustment: (Referred to summing point.) $\pm 20 \mu v$.
Chopper Frequency: 190 to 300 cps, non-synchronous.
DC Output Capability: Voltage, $\pm 10 v$; current, $\pm 10 ma$, dc to 10 kc (6 db/octave decrease, 10 kc to 1 mc).
Overload: Amplifier Limiting, ± 10.5 to $\pm 11.5 v$ output; recovery, equal to rise time plus 20 μs (5 ma max. to sum point).
Output Load: Max. capacitive load for stability, 0.1 μf for gain > 10 ; 0.01 μf for gain < 10 . Short circuit does not damage instrument.
Power: 115 or 230 v $\pm 10\%$, 50 to 1000 cps, 4 watts approx.
Dimensions: 3" high, 5" wide, 17" deep.
Weight (includes a plug-in): Net 6 lbs. Shipping 12 lbs.
Accessories Available: 8048-0029 Combining Case, including mating rear connectors for six amplifiers, \$200. 5060-0792 Filler Panel, covers one unoccupied panel opening in combining case, \$3 ea. 5060-0828 Control Panel Cover, converts combining case to carrying case, \$23.
Options: Overload Indication, front panel lamp and output signal provided under overload conditions. Order DY-2460A-M1, \$430.
Price: DY-2460A Amplifier (less plug-in), \$395.

Specifications DY-2461A-M1 Data Systems Plug-in

Gain (Inverting): Fixed settings, 10, 30, 100, 300, 1000 ($x0$ position shorts output); adjustment, $\pm 2\%$ on each range (front panel screwdriver control).
DC Gain Accuracy: (Calibrated on $x10$ range, temp. range 0 to $55^\circ C$.) $x30 \pm 0.6\%$, $x100 \pm 0.6\%$, $x300 \pm 1.3\%$, $x1000 \pm 1.3\%$.
DC Gain Stability: $\pm 0.01\%$ per week at constant temp.; $\pm 0.01\%/^\circ C$ max. temp. coefficient.
DC Linearity: $\pm 0.01\%$ at any gain setting.
Input Resistance: $100K \pm 0.2\%$, 50 pf nominal.
Overload Capacity: 300 v peak or 220 v rms (whichever is less).
Output Resistance: 50 milliohms maximum.

Six DY-2460A Amplifiers with DY-2461-A-M1 plug-ins mounted in 8048-0029 combining case.

Bandwidth and Settling Time: (Signal must be within output capability, see DY-2460A specifications.)

Gain	Minimum 3 db Bandwidth	Maximum Settling Time to 0.1%
$x10$	50 kc	25 μs
$x30$	15 kc	76 μs
$x100$	5 kc	250 μs
$x300$	1.5 kc	750 μs
$x1000$	500 cps	2.5 ms

Price: Plug-in, \$85; combined with amplifier, \$480.

Specifications DY-2461A-M2 Bench-Use Plug-in

Gain (Inverting): Fixed Settings, 1, 10, 100, 1000 ($x0$ position shorts output); vernier, extends gain, each setting, from $x1$ to $x10$.
DC Gain Accuracy: (Vernier at 1; temp. range 0 to $55^\circ C$): $x1 \pm 0.6\%$; $x10 \pm 0.6\%$; $x100 \pm 1.3\%$; $x1000 \pm 2\%$.
DC Gain Stability: $\pm 0.01\%$ per week at constant temp. (Vernier at 1); $\pm 0.01\%/^\circ C$ max. temp. coefficient.
DC Linearity: $\pm 0.01\%$ at each setting (Vernier at 1).
Input Resistance: $100K \pm 0.2\%$.
Overload Capacity: 300 v peak or 220 v rms (whichever is less).
Output Resistance: 50 milliohms max.

Bandwidth and Settling Time: (Signal must be within output capability; see DY-2460A specifications.)

Gain	Minimum 3 db Bandwidth	Maximum Settling Time to 0.1%
$x1$	50 kc	25 μs
$x10$	50 kc	25 μs
$x100$	5 kc	250 μs
$x1000$	500 cps	2.5 ms

Price: Plug-in \$125; combined with amplifier, \$520.

Specifications DY-2461A-M3 Patch Unit Plug-in

Patch panel provides connections for up to 3 inputs and 1 feedback path. Inputs, output, circuit ground and chassis ground available at both front panel and rear connector. Summing point available at front panel only. Overload signal at rear only.
Price: Plug-in, \$75; combined with amplifier, \$470. Includes four component plugs.

Specifications DY-2461A-M4 Plus-One Gain Plug-in

Gain: $x1$. Non-inverting.
DC Gain Accuracy: (Includes linearity, long term stability, 0 to $55^\circ C$) $\pm 0.005\%$ into 1K; $\pm 0.0002\%$ into 100K.
Input Resistance: 10^{10} ohms, for relative humidity up to 70% at $40^\circ C$.
Overload Capacity: 300 volts peak or 220 volts rms (whichever is less).
Output Resistance: 50 milliohms maximum.
Overload Recovery: Maximum input for 1 ms recovery (to 0.1%) $\pm 300 v$.
Price: Plug-in, \$35; combined with amplifier, \$430.

Data subject to change without notice.

350C,D ATTENUATORS

Match 500- or 600-Ohm Lines, 5 Watt Capability

When a high order of accuracy, wide frequency response, large power handling capacity or special features are required, *hp* 350 series attenuators are of great value and convenience. They are particularly useful in attenuating output of audio and ultrasonic oscillators, measuring gain and frequency response of amplifiers, measuring transmission loss, and increasing the scope and usefulness of other laboratory equipment.

Two attenuator sections in cascade make up the 350 Attenuators. One section is a 100-db attenuator, adjusted in 10 db steps. The other is a 10-db attenuator, adjusted in 1 db steps. Frequency response is flat to 1 mc. Two standard impedance levels are available: Model 350C for 500-ohm systems and Model 350D for 600-ohm systems. The instruments have large power handling capacity, 5 watts at any attenuator setting, and are ideal for ultrasonic and other work involving measurements above the range of conventional audio-frequency attenuators. Further, attenuator ground may be dc-isolated from the cabinet to eliminate troublesome ground loops.

Specifications

Attenuation: 110 db in 1 db steps.

Accuracy, 10 db section: From dc to 100 kc, error is less than ± 0.125 db at any step. From 100 kc to 1 mc, error is less than ± 0.25 db at any step.

Accuracy, 100 db section: From dc to 100 kc, error is less than ± 0.25 db at any step up to 70 db; less than ± 0.5 db above 70 db. From 100 kc to 1 mc, error is less than ± 0.5 db at any step up to 70 db; less than ± 0.75 db above 70 db.

Power Capacity: 350C, 500 ohms: 5 watts (50 v dc or rms) maximum, continuous duty; 350D, 600 ohms: 5 watts (55 v dc or rms) maximum, continuous duty.

DC Isolation: Signal ground may be ± 500 v dc from external chassis.

Dimensions: 6-3/32" high, 5 1/8" wide, 8" deep.

Weight: Net 5 lbs. Shipping 7 lbs.

Accessories Available: *hp* 11000A Cable Assembly, 44" of RG-58C/U 50-ohm coaxial cable terminated by dual banana plugs, \$4.50. *hp* 11001A Cable Assembly, as above, but with one BNC male connector, \$5.50.

Price: 500-ohm Attenuator, *hp* 350C, \$125; 600-ohm Attenuator, *hp* 350D, \$125.

Data subject to change without notice.

NEW IN THIS
CATALOG

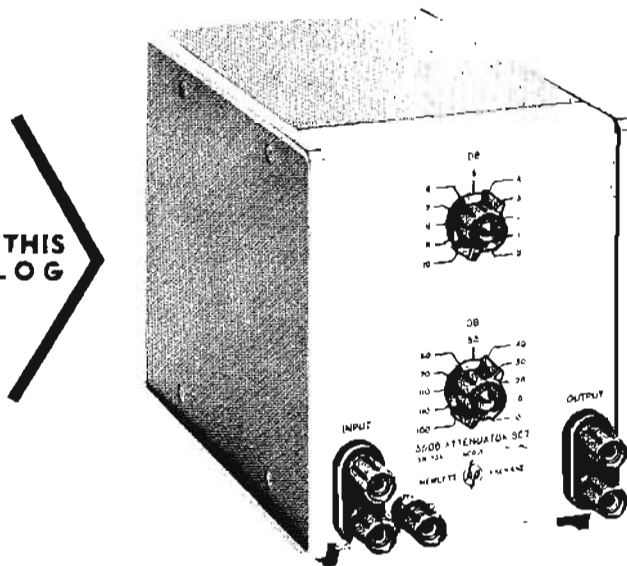

 350D

FREQUENCY and TIME

Measuring Instrumentation

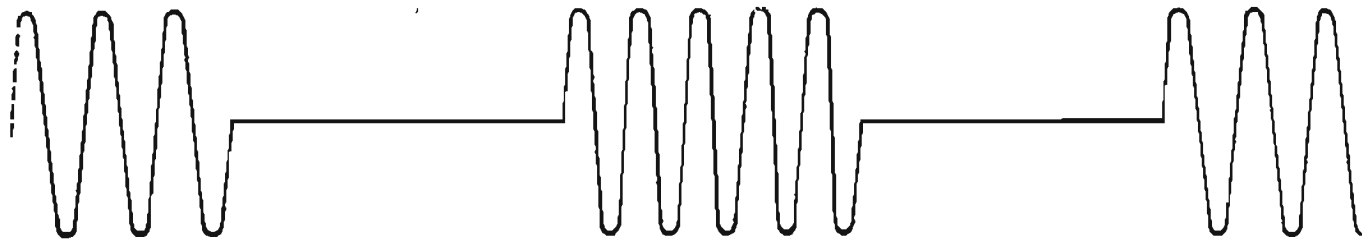

Electronic Counters
Frequency and Time Standards
Digital Recorders
Frequency Meters
Frequency Synthesizer

FREQUENCY AND TIME MEASURING EQUIPMENT

Electronic counters have proven to be the most accurate, flexible and convenient instruments for making both frequency and time interval measurements. Since introducing the first high-speed (10 mc) counter more than 10 years ago, Hewlett-Packard has developed a broad range of counters with many features. Collectively, these counters and associated equipment measure frequencies from 0 cps to 40 gc, and time intervals from 0.01 μ sec to 100 days. Instrument stability during these measurements is as high as 3 parts in 10^4 per day.

The Hewlett-Packard line includes digital recorders, for automatic recording of counter measurements, and digital clocks which control measurement intervals and supply time information for simultaneous recording. Analog records of repetitive measurements are obtained from digital counters with the aid of Hewlett-Packard digital-to-analog converters. Hewlett-Packard also manufactures magnetic and optical tachometer heads for rpm measurements.

An electronic counter is primarily a system for comparing an unknown frequency or time interval to a known frequency. The counter's logic presents this information in an easy-to-read, non-ambiguous, numerical display. The accuracy of this measurement depends primarily on the stability of the known frequency, which is controlled by the counter's internal time base oscillator. The oscillators in Hewlett-Packard counters are exceptionally stable, insuring accurate measurements. Hewlett-Packard counters are engineered for dependability, accuracy and ease of operation.

A decision on which electronic counter is best suited for specific applications depends on the range of anticipated measurements. The *hp* 524C,D (10 mc), 5243L (20mc), and 5245L (50 mc) counters offer the widest frequency ranges, highest accuracy and most flexibility through use of special application plug-in units. The simplest *hp* counters are the models 521A,D, which have maximum counting rates of 120 kc, 4-place readout, and a 0.1% accurate time base derived from the ac power line. Other counters in the *hp* line lie between these extremes in regard to their

maximum counting rates, their accuracy, resolution and flexibility.

Hewlett-Packard counters which carry a 4-digit designation (e.g., 5212A, 5243L) represent a new family of instruments which take advantage of recent advances in solid-state component development to achieve compactness and ruggedness, while realizing new operational convenience. They are packaged in the *hp* modular cabinets. Among the new features offered by these instruments are display storage, which retains the previous count while a new count is being made, and remote control.

Counter Operation

An electronic counter has several functional blocks which are interconnected in various ways for making the different types of measurements. The most important functional blocks are: 1) the decade counters, with their numerical display, which totalize the count; 2) the signal gate, which starts and stops the count; and 3) the time base, which supplies the precisely known increment of time during which pulses are counted. Other blocks include the signal conditioning circuits, which form various input signals into suitably-shaped pulse trains, and the logic control system. Logic control interconnects the circuits for the desired measurement, selects the appropriate measurement units display, and initiates the measurement cycle. The various modes of counter operation are described in the following paragraphs and accuracy is discussed on Page 122.

Frequency Measurement

To make frequency measurements directly, the circuits feed the shaped input

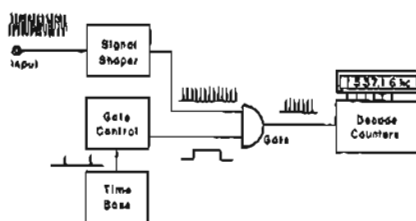

Figure 1. Frequency measurement. Function Selector is set to "Frequency" and appropriate gate time is selected by Time Base switch (combined with Function Selector on some counters).

signal through the gate to the decade counters as shown in Fig. 1. Logic control makes the measurement by opening the gate for a selected time. The number of pulses totalized by the counters during the gating interval, retained on the display numerals following gate closing, indicates the frequency of the input signal. After a time, selected by the "Sample Rate" control, the decade counters are reset to zero and the measurement is repeated.

The Time Base switch, besides selecting the gating interval, sets the display's decimal point and appropriate measurement units.

Rate Measurements

Frequency measurements may be normalized automatically to rate measurements in any units by appropriate selection of the time base. To facilitate normalized measurements, the time base decades of the 5214L Preset Counter can be set to open the counter gate for a time equal to a selected number of periods of the time base oscillator frequency. For instance, selection of a 600 millisecond gate time to work with a 100 pulse-per-revolution tachometer generator enables the 5214L to display shaft revolutions in units of rpm directly.

Period Measurements

To make period measurements, counter functions are interchanged, as shown in Fig. 2. The gating interval now is controlled by the unknown signal, and a much higher frequency from the time base is totalized during the

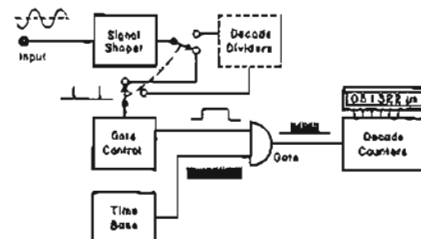

Figure 2. Period measurement. Function Selector is set to "Period" and counted frequency is chosen by Time Base switch.

time the gate is open. The circuits select the positive-going zero axis crossings of successive cycles of the input waveform as trigger points for opening and closing the gate.

Consider now a period measurement where 1 mc is selected as the "counted" frequency, each time increment then being 1 μ sec. During a measurement cycle, the counter totals 51322 counts and displays 051322. μ sec as the period of the input signal. The ± 1 count ambiguity, inherent in gate-and-count measurements, affects the least significant digit, which means that this measurement was accurate to $\pm 1 \mu$ sec, excluding time base and trigger errors.

Multiple Period Averaging

The effect of the ± 1 count ambiguity and trigger error are reduced even further by multiple period averaging. Here, the switch in Fig. 2 (ganged to the Function Selector) is changed to receive the output of the Decade Dividers (shown in dotted lines). The input frequency now is "counted down" or divided by some factor, say 10. The measurement is thus extended to 10 periods of the input signal, increasing the resolution by one more significant decimal place. The effect of the ± 1 count ambiguity and trigger error is reduced by a factor of 10. In the preceding example, the counter may display 51322.5 μ sec with 10-period averaging. (The Function Selector automatically places the decimal point to show the average duration of *one* period.)

Time Interval Measurements

Time interval measurements are similar to period measurements, except that the trigger points on the signal waveform or waveforms are adjustable. As shown in Fig. 3, separate signals may be used as start and stop signals or, by switching the Com-Sep switch to "com," measurements may be made from one point on a waveform to another point on the same waveform. Triggering polarity, amplitude and slope are selected for each channel independently. The time interval is displayed in units of microseconds, milliseconds or seconds. Accuracy is affected by the same factors which affect period measurements.

Extremely short time intervals (10 nanoseconds to 0.1 second) can be

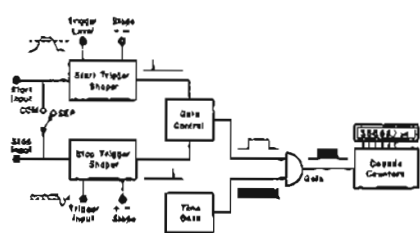

Figure 3. Time Interval measurements. Start and stop triggers may be derived from two separate sources, as shown, or from different points of one waveform by setting Com-Sep switch to "Com."

measured accurately with the 5275A Time Interval Counter. This instrument, using a 1 mc external standard oscillator, multiplies the 1 mc to 100 mc to obtain 10 nanosecond time increments as the "counted" frequency, obtaining exceptionally fine resolution. Applications of this instrument include explosive burning rates, timing of high speed vehicles and nuclear measurements.

Measurement of the time required for a number of random events to occur is possible with the 5214L Preset Counter. This instrument's decade dividers may be preset to close the gate on the Nth input pulse, where N is any number from 1 to 100,000.

Phase Angle Measurements

Phase angle measurements are similar to period measurements. The measurement actually shows the time difference between similar points on the two waveforms and it is converted to phase angles by a simple calculation.

Automatic conversion and display in units of degrees is possible through use of a suitably chosen external signal as the "counted" frequency. For example, if the counted frequency were 3600 times the frequency of the signals being measured, the results would be displayed in tenths of degrees. The 526D Phase Unit plug-in for the 524 series counters includes a 3600 frequency multiplier for making this conversion with 400 cps ± 4 cps servo signals.

Frequency Ratio Measurements

The ratio of two frequencies is determined by using the lower frequency signal for gate control while the higher frequency signal is counted, as shown in Fig. 4. With proper transducers, ratio measurements may be extended to

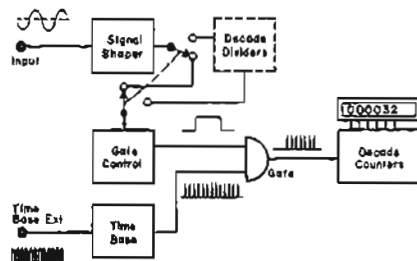

Figure 4. Frequency ratio measurements. Function Selector is set to "Period" and Time Base switch to "external." Lower frequency serves as gate control while higher frequency replaces time base as "counted" frequency.

any phenomena which may be represented by pulses or sine waves. Gear ratios and clutch slippage, as well as frequency divider or multiplier operation, are some of the measurements which can be made with this technique.

Accuracy is ± 1 count \pm trigger error. Accuracy may be improved with multiple period averaging by extending the duration of the measurement for several periods of the lower frequency.

Scaling

The new *hp* solid-state counters may be used for scaling (dividing down) input counts by powers of 10. Use is made here of the time base decade dividers, so that outputs may be taken from any of the dividers in the chain. For example, a 14 mc signal may be scaled down to as far as 0.14 cps by Model 5243L or to 0.014 cps by Model 5245L. Pulse resolution is the same as for random event counting.

The gate of the 5214L Preset Counter generates an output pulse at the conclusion of any selected number of input counts between 1 and 100,000.

High Frequency Measurements

Measurements of frequencies above the normal range of a counter are possible with *hp* counters having plug-in capability (524C,D, 5243L, 5245L). The plug-ins convert (heterodyne) the unknown high frequency to a related frequency which is within the counter's basic range. Counter accuracy is retained, since a harmonic of the time base oscillator is used as the heterodyning signal for the frequency conversion.

The heterodyning signal is mixed with the unknown signal, and the difference frequency is passed to the counter for measurement, as shown in the

block diagram of Fig. 5. The frequency converter's tuning control, which selects

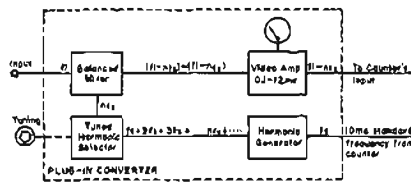

Figure 5. High frequency measurements. Meter shows when Harmonic Selector is tuned to desired harmonic which generates difference frequency within range of counter.

one of the several 10 mc harmonics, indicates the frequency of the selected harmonic. This value, when added to the counter's reading, gives the frequency of the unknown signal.

Measurements to 40 gc are possible with the addition of the 540B Transfer Oscillator and related equipment¹. This oscillator, operating in the 100 to 220 mc range, generates harmonics to at least 12.4 gc.

As shown in Fig. 6, the unknown signal is fed to a crystal mixer within

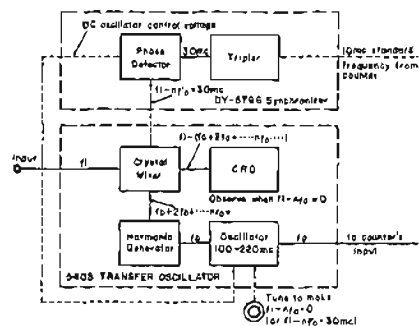

Figure 6. High frequency measurements with Transfer Oscillator. Operation is modified by addition of Dymec 5796 Synchronizer, shown connected by dotted lines.

the transfer oscillator. The oscillator is tuned to a sub-multiple of the measured frequency, a built-in cathode ray tube indicating when tuning achieves a zero beat between the measured frequency and one of the oscillator's harmonics. The counter, with appropriate plug-in, reads the 540B Oscillator's fundamental frequency which, when multiplied by the harmonic number, gives a precise determination of the measured frequency. If the harmonic number is not known, it can be determined by a simple procedure involving a second reading at a higher setting of the oscillator's frequency. The P932A Harmonic Mixer, which mounts directly on a waveguide system, extends this technique to 18 gc.

Oscillator synchronizing equipment is available from Dymec (see pages 218,

219) for phase-locking the transfer oscillator to the unknown signal². This system simplifies data taking of a drifting signal. With the synchronizer connected as shown in Fig. 6, the transfer oscillator is tuned so that one of its harmonics is offset from the measured frequency by 30 mc (30 mc subsequently is added to the final frequency calculation). The resulting 30 mc beat from the mixer is compared to a standard 30 mc signal, and a dc voltage proportional to the phase difference between the two is derived. The dc voltage, applied to a frequency control circuit, "pulls" the transfer oscillator frequency sufficiently to maintain a precise 30 mc offset. The counter readings thus track any drift in the input signal.

House Frequency Standards

The time-base oscillators in *hp* high-performance counters have stabilities of a level ordinarily found only in oscillators intended for use as frequency standards. As such, these counters (524C,D, 5243L, 5245L) often serve as in-house frequency standards, in addition to performing their assigned measurement tasks.

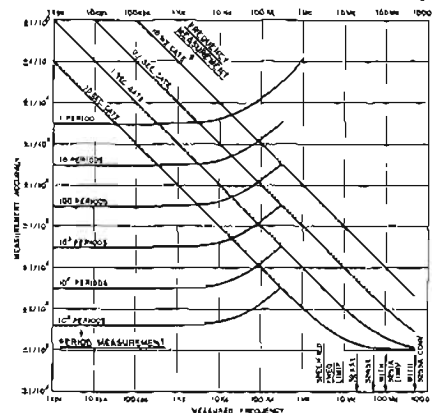

Figure 7. Attainable accuracy of 5243L or 5245L Counter. Period measurement accuracy is based on 10 mc counted frequency. Time base accuracy is assumed to be 1 part in 10⁹.

The oscillator of the 5243L, for instance, has an aging rate of less than ± 3 parts in 10^9 per 24 hours (after 72 hrs. of continuous operation). A $\pm 10\%$ change in the nominal 115 or 230 v line voltage can vary the basic frequency by no more than ± 5 parts in 10^{10} . Ambient temperature affects the frequency by less than ± 2 parts in 10^{10} per degree C throughout a range from -20 to $+55$ degrees C.

Counter Accuracy

The attainable accuracy of a particular counter is shown in Fig. 7. This is a

plot of accuracy vs. frequency and clearly shows the cross-over point below which determination of frequency is better performed by period measurement. Maximum attainable accuracy is limited by the stability of the time base oscillator, which controls the exact opening and closing of the counter gate. Time base accuracy is affected by drift rate of the individual time base, absolute value of frequency offset at standardization and the time lapse since standardization.

The ± 1 count ambiguity is inherent in measurements made with an electronic counter because the gating is normally not coherent with the input signal. The gate may open or close while an input pulse is passing through, so that this pulse may or may not be included in the final count. The degree to which the ± 1 count ambiguity affects measurement accuracy is determined by the factor $1 \div$ displayed count. For example, a measurement of a 400 kc signal made with a 10-second gate is accurate to $1/4,000,000$ or $\pm 2.5 \times 10^{-7}$ (\pm time base accuracy).

The accuracy of period measurements also is affected by the "trigger error", a function of input signal-to-noise ratio

and rise time, as well as being affected by time base stability and the ± 1 count ambiguity. All of these are related by the formula:

$$\text{Percent Accuracy} = 100 \left(\pm \frac{f_1}{nf_s} \pm \frac{e}{n} \pm E \right)$$

where f_1 = frequency of measured input signal in cps.

f_s = time base (standard) frequency counted in cps.

n = number of periods averaged.

e = trigger error $\leq 3 \times 10^{-3}$ for a sine wave with $S/N = 40$ db

E = time base accuracy expressed as a decimal.

¹"Measuring Frequency from VHF up to and above 18 gc with Transfer Oscillator/Counter Techniques," Hewlett-Packard Application Note No. 2.

²Benjaminson, A. "An Instrument for Automatically Measuring Frequencies from 200 mc to 12.4 gc," Hewlett-Packard Journal, Vol. 13 No. 3, Nov. '61.

SOLID STATE COUNTERS

An integrated development program combining advances in component development and numerous innovations in instrument layout and design has generated a complete family of solid state frequency and time measuring devices. These Hewlett-Packard instruments provide:

1. **Display storage**—making readings possible even while a count is in progress.
2. **Faster repetitive counts**—display time is no longer limited to an integral multiple of the gate time.
3. **Solid state circuits**—with low heat dissipation and reliable operation from -20 to $+65^{\circ}\text{C}$.
4. **Positive frequency division**—giving maximum reliability to all gate times.
5. **Multiple period average**—improving period measurement accuracy, even for noisy signals.
6. **Plug-in modules**—for clean design and easy service.
7. **Compact, stackable cabinets**—only $3\frac{1}{2}$ or $5\frac{1}{4}$ inches of rack space required.

Hewlett-Packard solid state counters are compact, light, have low power consumption and can operate over a wide temperature range. Plug-in module construction increases instrument versatility, simplifies maintenance, and helps assure uniform high quality.

Conservative design features, such as the use of decade dividers in the gate generating circuits, greatly improve operational stability. This positive-action frequency division, combined with front panel self-check provisions, gives confidence in readings at every position of the function selector switch.

Dual use of decade dividers in these counters permits multiple period average and ratio measurements as a standard feature, increasing measurement accuracy in proportion to the multiplication factor.

Display storage provides a continuous reading even while the instrument is totalizing a new count. Only if the new count differs from the previous count will the display change, in which case it will shift directly to the new reading. For most repetitive measurements, this feature makes displays easier to read. For appropriate applications, storage may be disabled by a rear panel switch.

Sample rate, which controls the dead or off time between readings, is adjustable from approximately 0.2 seconds to 5 seconds for frequency measurement and is independent of the gate time. For 1- and 10-second gates, this substantially increases the number of samples possible during a given time.

Output in four-line BCD (1-2-2-4) is available for system use or operation of output devices such as the *hp* 562A Digital Recorder (see page 146) and *hp* 580A, 581A Digital-to-Analog Converters (see page 149). These solid state counters are also available with a four-line (1-2-4-8) BCD output.

Thirteen solid state counters are described on the following pages. The various models available differ in maximum counting rate (300 kc to 100 mc), functions performed, time base stability and type of visual readout.

Included in the group photograph (right) are Models 5211B, 5512A and 5212A 300 KC Electronic Counters; 5532A and 5232A 1.2 MC Electronic Counters; 5233L 2 MC Electronic Counter; 5275A 10 nsec Time Interval Counter; 5245L 50 MC Electronic Counter with 5262A Time Interval plug-in, and 5243L 20 MC Electronic Counter with 5253A 100 to 500 MC Frequency Converter plug-in.

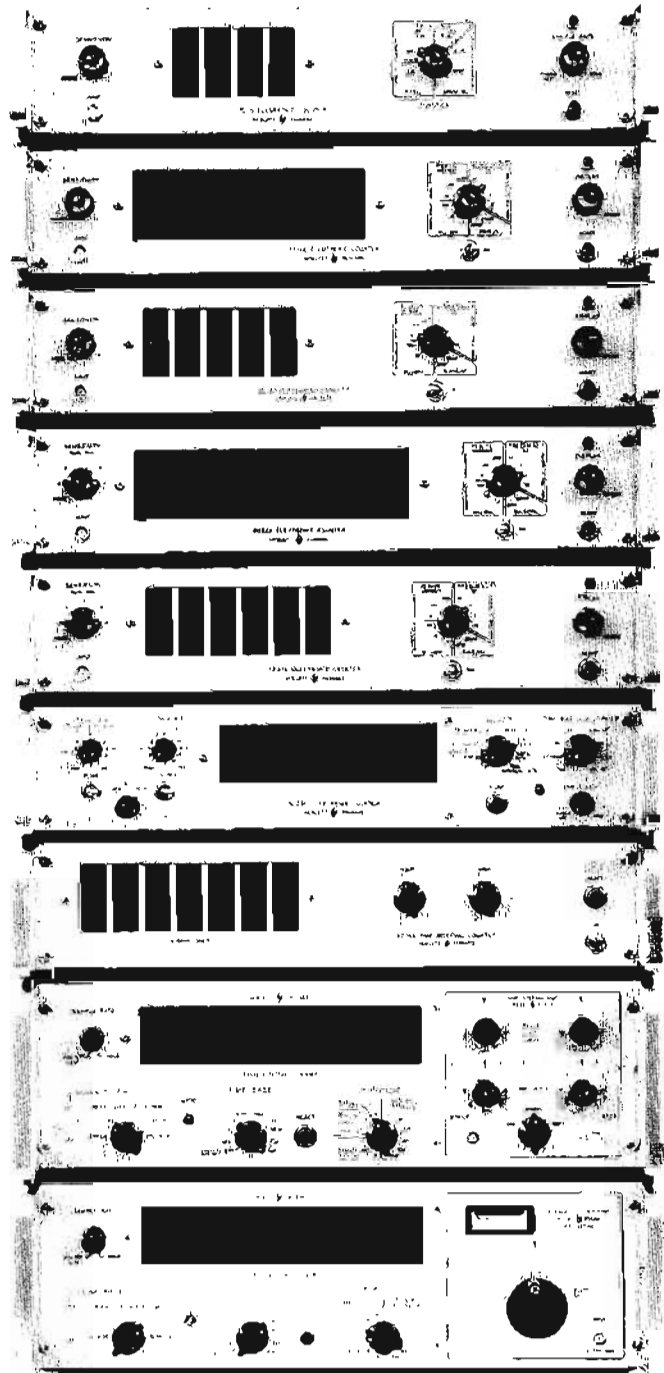

**hp 5211A AND B, 5212A, 5512A, 5232A, 5532A
ELECTRONIC COUNTERS**

**Compact, Solid State Counters
Provide Measurement Versatility
to 300 KC, 1.2 MC**

**5212A, 5512A, 5232A
and 5532A Counters**

With this group of solid state instruments, two basic counters give maximum counting rates of 300 kc and 1.2 mc, with a choice of column or in-line readout. Each makes direct frequency, period, multiple period average and ratio measurements. Models 5212A and 5512A have a maximum counting rate of 300 kc, 5-digit resolution and respective displays of neon columns and long-life Nixie® tubes. Models 5232A and 5532A have maximum counting rates of 1.2 mc and 6-digit resolution with the same readout choice.

The front panel of each counter has input attenuation control, display control, reset button and function switch. In the rear are the storage-disable switch, external standard input jack (which permits use of an external oscillator as the counter time base) and digital recorder output connector. Self-check is provided for both frequency and period measurement modes.

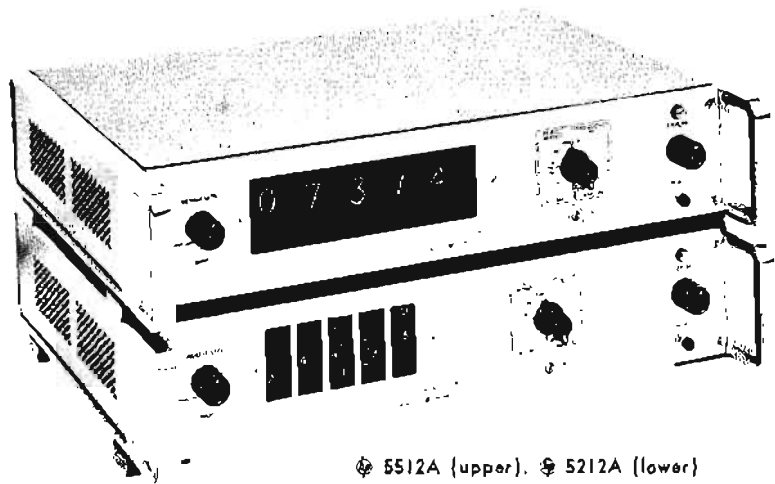

5212A (upper), 5212A (lower)

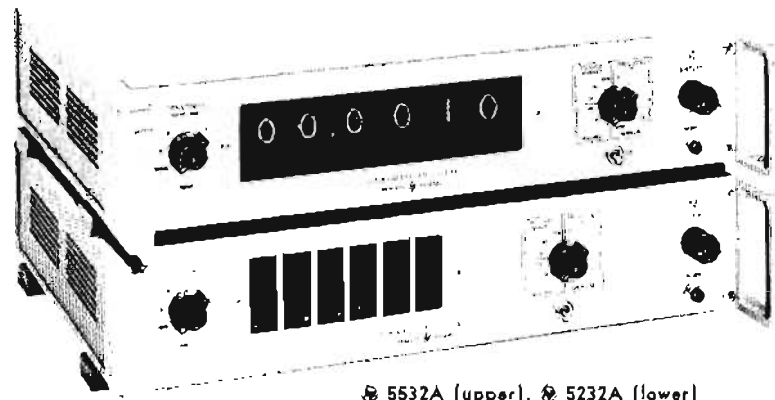

5532A (upper), 5232A (lower)

Period and Multiple Period Average Measurement

Counter	Max. Counting Rate	Registration	Time Base	Range	Accuracy	Reads In	Periods Averaged
5211A, B	300 kc	4 digits columnar	Power line; accuracy typically $\pm 0.1\%$ or better				
5212A	300 kc	5 digits columnar	Crystal oscillator; aging rate, $\pm 2/10^6$ /week	2 cps to 300 kc			
5512A	300 kc	5 digits Nixie Indicators			\pm one count time base accuracy \pm trigger error	Milli-seconds or microseconds with positioned decimal	1, 10, 10^2 , 10^3 , 10^4 , 10^5
5232A	1.2 mc	6 digits columnar					
5532A	1.2 mc	6 digits Nixie Indicators	Crystal oscillator; aging rate $\pm 2/10^7$ /month	2 cps to 1.2 mc			

NEW IN THIS
CATALOG

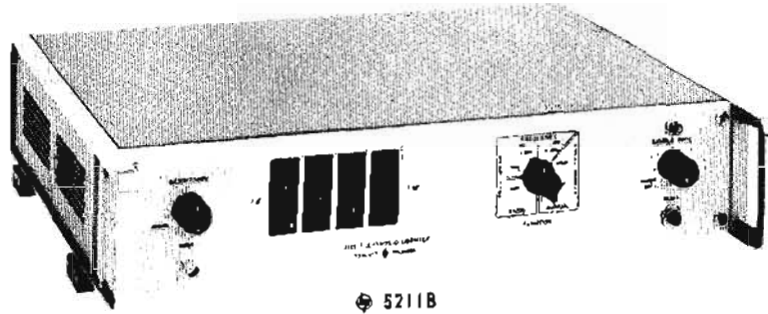

5211A,B Counters

Models 5211A and 5211B have a maximum counting rate of 300 kc and make direct frequency and ratio measurements. They also measure speed in rpm and rps when used with transducers and count events occurring within a selected period of time. They offer four-digit resolution and neon columnar display. They are identical except for gate times. The 5211A has gate times of 0.1 and 1 second; the 5211B has a third gate time of 10 seconds.

Both offer manual control of the gate by a front-panel function switch, by external contact closure or by 3 volt peak positive pulses at least 10 μ sec wide at half amplitude points. Time base is derived from the power line, and since power line frequency is usually held to better than 0.1%, the counters have an accuracy fully adequate for most industrial measurements.

Common Features

These six Hewlett-Packard electronic counters offer the advantages of solid state construction, broad measurement capabilities, rugged and compact packaging and a wide selection of performance characteristics.

Maximum counting rate ranges from 300 kc to 1.2 mc. A variety of visual readouts have from 4 to 6 digits, in both Nixie[®] tube and neon columnar displays. Features offered in common by all six counters include modular cabinets only 3 1/2" high, low heat dissipation and power consumption with solid state components, 0.1 v sensitivity, display storage for non-blinking readout, four-line BCD output for

systems and recorders, flexible operation and reduced operator errors. When a counter is in the frequency mode, the time between counts is adjustable from less than 0.2 second to more than 5 seconds and is independent of gate time. Because time between counts is not dependent upon gate time, faster sampling rates are often possible.

The instruments are compact and reliable, have low power consumption and can operate with specified accuracy over a wide temperature range. Plug-in module construction increases instrument versatility and simplifies maintenance. Conservative design features, such as the use of decade dividers in the gate generating circuits, provide operational stability and eliminate calibration problems. Input sensitivity is 0.1 volt rms; input impedance, 1 megohm.

Specifications

General

Weight: Less than 15 lbs.

Dimensions: 16 3/4" wide, 3 1/2" high, 11 1/2" deep. Hardware furnished for converting to 19" wide by 3 1/2" high rack mount.

Power: 115 or 230 volts \pm 10%, 50 to 60 cps*, less than 40 watts.

Accessories Furnished: hp 10503A Cable, 4 feet long, BNC connectors; detachable power cord; circuit board extender.

Data subject to change without notice.

*hp 5211A,B requires 50 or 60 cps operation (specify Option 01 for 50 cps operation); 5212A, 5512A, 5232A and 5532A operate between 50 and 60 cps line frequency with limit imposed by fan. For operation up to ambient of 50°C, line frequency may be 50 to 1000 cps.

©Burroughs Corporation

Frequency Measurement

Ratio Measurement

Range	Accuracy	Reads In	Gate Time	Reads	Range	Accuracy	Price
2 cps to 300 kc	\pm 1 count \pm time base accuracy	kc, cps with positioned decimal	1, .01 second 5211B additionally: 10 seconds	f_1/f_2	f_1 : 2 cps to 300 kc (0.1 v rms) f_2 : 100 cps to 300 kc (1 v rms into 1000 ohms)		5211A \$750
							5211B \$825
2 cps to 1.2 mc	\pm 1 count of f_1 \pm trigger error of f_2	kc with positioned decimal	10, 1, 0.1, 0.01 seconds	$f_1/f_2 \times$ period multiplier	f_1 : 100 cps to 300 kc (1 v rms into 1000 ohms) f_2 : 2 cps to 300 kc		\$975
					f_1 : 100 cps to 1.2 mc (1 v rms into 500 ohms) f_2 : 2 cps to 300 kc		\$1175
							\$1300
							\$1550

hp 5233L ELECTRONIC COUNTER

Versatile 2 MC Counter

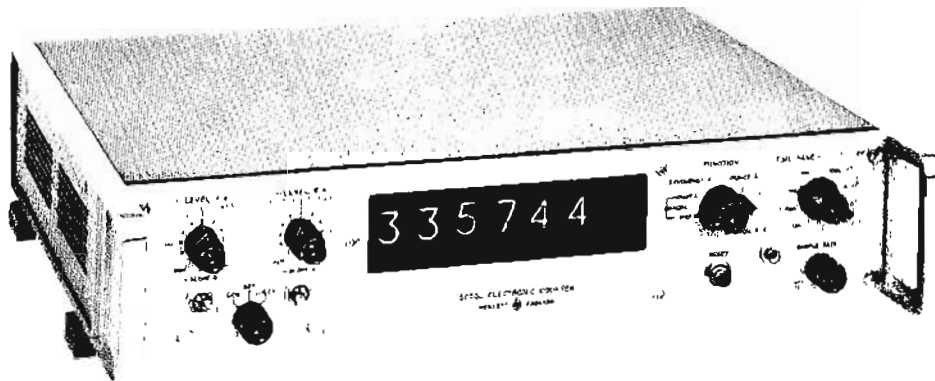

NEW IN THIS
CATALOG

Advantages:

- Superior trigger level controls usable in all functions
- Increased readability with new rectangular Nixie® tubes
- Manual scaling permits long term averaging without exceeding readout capacity
- Minimum bench or rack space, 3½" high
- Reliable, rugged and completely solid state

The hp 5233L Electronic Counter makes frequency, period, multiple period average, time interval, ratio and multiples of ratio measurements. A counting rate greater than 2 mc and 6-digit resolution are offered in an in-line display of rectangular Nixie Indicating Tubes, which retain the full numeral size and permit accurate reading at a glance. With completely solid state components, the 5233L offers high input impedance of 1 megohm and sensitivity of 0.1 volt rms.

Measurements are made automatically, and the automatic readout includes measurement unit and correctly positioned decimal. Controls are simplified and arranged for easy operation.

The superior trigger level controls are usable in all functions. Drift of the new differential dc amplifiers used in the input circuits is unusually low, permitting a more accurate definition of the trigger points.

Model 5233L is compact and reliable. Power consumption is low, and the counter performs to specified accuracy over a wide temperature range. Plug-in module construction increases versatility, simplifies maintenance and helps assure uniform high quality. Conservative design features provide operational stability and eliminate calibration problems.

Frequency Measurements

The 5233L measures frequencies and repetition rates of periodic and random pulses from 0 to above 2,000,000 pps. Gate times from 10 μ sec to 10 sec in decade steps are selected with a front-panel switch. A refined trigger input circuit is used, and only input signals meeting acceptable conditions set on the trigger level and slope controls will be counted. This permits triggering at any point on the input signal and prevents counting noise or other unwanted signals.

Multiple Period Average Measurements

With the 5233L you may make multiple period average measurements up to 10^7 periods. This period multiplication increases period measurement accuracy by a factor equal to the multiplication factor and is especially useful at frequencies where the one count ambiguity characteristic of electronic counters limits the accuracy of direct frequency measurements. Period measurements are possible near the top of the counter frequency range with an accuracy comparable to that obtained by direct frequency counting.

Period Measurements

While one period may be obtained using the x1 multiplier of period average, period measurement as a separate function permits added versatility. For measurement of low frequencies the Period measurement on the 5233L can be used to reduce the counted time base frequency by a factor up to 10^7 for convenient readout of the long term period. Thus, the display shows the total period without "spillover", even for extremely low frequencies.

Time Interval Measurements

The time interval between any two events can be measured with the 5233L over the range of 10 μ sec to 10,000,000 sec. Separate start and stop channels are provided, and each channel is equipped with a trigger level control covering a range of -100 to +100 volts. Coupling may be either ac or dc, and trigger slope positive or negative. Rear terminals provide pulses whenever trigger level and slope conditions are met, and these pulses may be used for intensity modulating an oscilloscope to indicate the beginning and end of the time interval measurement. The pulses also are useful for triggering auxiliary equipment.

Other Measurements

The 5233L also reads ratio, multiples of ratio, random events and other electrical events. Because events may be scaled down by factors as high as 10^7 , depending on the multiplier setting, counting random events over extended time intervals is easy in manual gate without exceeding the 5233L readout capacity.

Self-check provisions controlled from the front panel are incorporated in the 5233L, and display storage provides a non-blinking readout of the most recent measurement, shifting directly to a new reading only if the actual count changes. Display storage may be disabled by a rear panel switch.

The 5233L provides a four-line BCD code output for systems or recorder use. Hewlett-Packard modular construction provides bench and rack mount counter in a single instrument.

Specifications

Input Channels (A and B)

Range: DC coupled: 0 to more than 2 mc; ac coupled: 10 cps to more than 2 mc.

Impedance: Approximately 1 megohm, 80 pf shunt.

Sensitivity: 0.1 volt rms, sine wave; 1 volt pulse, 0.2 μ sec minimum width.

Trigger Level: - 100 to + 100 volts, adjustable, either positive or negative slope; independent controls on each channel.

Channel Inputs: Common, Separate, Check.

Marker Output: Available at rear panel for oscilloscope intensity modulation to mark trigger points on input waveforms; 1 μ sec duration and -15 volts peak.

Time Base:

Frequency (internal): 1 mc.

Stability: Aging rate: Less than ± 2 parts in 10^7 per month. As a function of line voltage: Less than ± 1 part in 10^7 for changes of $\pm 10\%$. As a function of ambient temperature: Less than ± 2 parts in 10^8 ($+10^\circ$ to $+50^\circ$ C), ± 20 parts in 10^6 (-20° to $+65^\circ$ C).

External Input: Sensitivity: 1 volt rms sine wave. Range: 100 cps to 1 mc, sine wave.

Outputs, Rear Panel:

Oscillator: 1 mc, 3 volts peak-to-peak. Time Base (separate BNC connector): 0.1 cps to 1 mc in decade steps, 5 volts peak-to-peak, 600-ohm source. Available in Period, Time Interval, and Manual without reset interruptions.

BCD Output

Output: 4-line BCD (1-2-2-4).

Impedance: 100K each line. "0" State Level: approximately - 8 volts. "1" State Level: approximately + 18 volts.

Reference Levels: Approx. + 17 volts, 350-ohm source impedance; and approx. - 6 volts, 1000-ohm source impedance.

Print Command: Step from - 9 volts to + 19 volts, dc coupled, 2700-ohm source impedance.

Hold-Off Requirements: Anywhere from + 2 volts to - 20 volts.

Manual

Input: Channel A.

Multiplier: Prescales input of Channel A in decades, 1 to 10^7 .

Totalize: Periodic events at rates to more than 2×10^6 /sec except 1.2×10^6 /sec when Multiplier is used to prescale. Random events with pulse spacing no less than 0.5 μ s (0.8 μ s when Multiplier is used to prescale).

Frequency

Input: Channel A.

Accuracy: ± 1 count \pm time base accuracy.

Reads In: KC or mc with positioned decimal.

Gate Time: 10 μ sec to 10 sec in decades.

Self Check: Counts 1 mc for the gate time chosen by Time Base selector.

Period

Range: 0 to 100 kc.

Input: Channel A.

Accuracy: ± 1 count \pm time base accuracy \pm trigger error.*

Reads In: MS or sec with positioned decimal.

Frequency Counted: 1 mc to 0.1 cps in decade steps.

Self Check: Gate time is 1 sec; frequency counted is 0.1 cps to 1 mc as selected by Time Base switch.

Period Average

Range: 0 to 1.2 mc.

Input: Channel A.

Accuracy: ± 1 count \pm time base accuracy \pm trigger error.*

Reads In: μ s or ns with positioned decimal.

Periods Averaged: 1 to 10^7 in decade steps.

Frequency Counted: 1 mc.

Self Check: Gate time is 10 μ sec to 10 sec (10 to 10^7 periods of 1 mc); counts 1 mc.

Ratio

Input: Channels A and B.

Range: Channel A (F_A): 0 to more than 2 mc. Channel B (F_B): 0 to 1.2 mc.

Measures: F_A (Multiplier)

F_B

Reads: $\frac{F_A}{F_B}$ or $\frac{1000F_A}{F_B}$ depending on Multiplier setting.

Accuracy: ± 1 count of $F_A \pm \frac{\text{trigger error of } F_B}{\text{Multiplier setting}}$

Multiplier: 1 to 10^7 in decade steps.

Self Check: Counts 1 mc for 10 μ s to 10 seconds depending on Multiplier setting.

Time Interval

Input: Channels A and B.

Range: 10 μ s to 10^6 seconds.

Accuracy: ± 1 count \pm time base accuracy \pm trigger error.**

Reads In: MS or sec with positioned decimal.

Measurement: Time from A to B.

Self Check: Period Self Check above applies, when levels and slopes of both channels are identical.

Scaling

Function Setting: Manual.

Input: Channel A.

Range: 0 to 1.2 mc.

Factor: By decades up to 10^7 .

Output: Rear panel in place of time base output frequencies.

General

Registration: 6 long-life in-line indicator tubes with display storage. Measurements Unit: Unit readout for Frequency, Period, Period Average, and Time Interval with positioned decimal point.

Sample Rate: Time following a gate closing during which the gate may not be reopened is continuously variable from less than 0.2 sec to 5 secs; independent of gate time; display can be held indefinitely.

Self Check: In all function and multiplier positions.

Operating Temperature Range: -20° C to $+65^\circ$ C.

Dimensions: $16\frac{3}{4}$ " wide, $3\frac{1}{2}$ " high, $11\frac{1}{2}$ " deep; rack mounting hardware furnished.

Weight: Net 19 lbs. Shipping 25 lbs.

Power Requirements: 115 or 230 volts $\pm 10\%$, 50 to 60 cps,*** 50 watts.

Price: \$1850.

Data subject to change without notice.

* With trigger level set at zero, either slope, trigger error for sinewave input is $\pm 0.3\%$ of one period for signals with 40 db signal-to-noise ratio.

** For any waveshape, trigger error is $\pm \frac{0.0025}{\text{Signal Slope (volts}/\mu\text{sec)}} \mu\text{sec}$.

Below 0.1 cps maximum error may increase up to 10 fold depending on line voltage and environmental conditions.

*** Line frequency limit imposed by fan. For operation up to ambient temperature of 50° C, line frequency may be 50 to 1000 cps.

hp 5242L, 5243L, 5244L, 5245L ELECTRONIC COUNTERS

Four High Frequency Counters Provide Choice of Time Base, Maximum Counting Rate, Special Features



NEW IN THIS
CATALOG

AVAILABLE
MID 1963

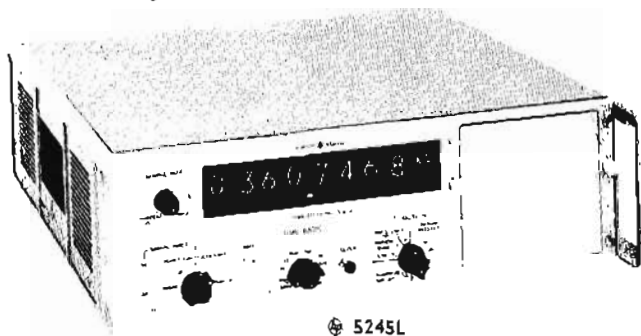

5245L

5243L and 5245L

The hp 5243L and 5245L are solid state counters offering unparalleled accuracy in measuring frequency, period, multiple period average, ratio and multiples of ratio. The basic counting rates are dc to 20 mc for 5243L and dc to 50 mc for the 5245L. Further, the 5243L and 5245L accept plug-ins which extend their maximum counting range to 512 mc, permit their use in measuring time interval, and extend their sensitivity to 1 mv (see page 130). They offer 8-digit resolution using an in-line display of rectangular indicating tubes. Panel height is only 5 1/4".

High Time Base Stability

Unprecedented accuracy is obtained with the 5243L and 5245L through use of a proportionally controlled oven to house the crystal time base. The high stability of better than ± 3 parts in 10^9 per day means the time base output may be used as a frequency standard.

Remote programmability of the time base and function controls is a standard feature. Further, all switching to produce the digital display is low voltage so that external transistor switching may be used where preferred.

An additional feature of the 5243L and 5245L is the scaling of signals. Any frequency up to the maximum counting rate may be divided by decade factors up to 10^6 (for the 5243L, 10^8 for the 5245L). A rear panel BNC output and switch provide a choice of standard output frequencies. Display storage provides a continuous display of the most recent measurement for a "non-blinking" readout. Four-line BCD

output is provided, suitable for systems use or for output devices. Each counter weighs less than 40 pounds.

5242L and 5244L

The 5242L (20 mc counter) and 5244L (50 mc counter) are similar to the 5243L and 5245L but differ primarily in time base stability and plug-in capability. These models also offer display storage and four-line BCD code output. Time base stability is better than ± 2 parts in 10^7 per month. Maximum sensitivity is 100 mv rms. Readout is a 7-digit in-line display of indicator tubes. Neither counter accepts plug-ins. The two counters weigh less than 30 pounds each.

Specifications, 5243L, 5245L

Frequency Measurements

Range: 5243L, 0 to 20 mc; 5245L, 0 to 50 mc.
Gate Time: 1 μ sec to 10 seconds in decade steps.
Accuracy: ± 1 count \pm time base accuracy.
Reads In: KC or mc with positioned decimal point; units annunciator in line with digital display.
Self Check: Counts 10 mc for the gate time chosen by the time base selector switch.

Period Average Measurements

Range: Single period: 0 to 1 mc; multiple period: 0 to 300 kc.
Periods Averaged: 1 period to 10^3 periods in decade steps.
Accuracy: ± 1 count \pm time base accuracy \pm trigger error.
Frequency Counted: Single Period: 10^1 cps to 1 cps in decade steps. Multiple Period: 10^1 to 1 cps at 10-period average, minimum frequency increases to 10^1 cps at 10^3 period average.
Reads In: Sec, msec, μ sec, with positioned decimal point; units annunciator in-line with digital display.
Self Check: Gate time is 10 μ sec to 1 sec (periods averaged of 100 kc); counts 100 kc from time base.

Ratio Measurements

Displays: (f_1/f_2) times period multiplier.
Range: f_1 : 5243L, 0 to 20 mc; 5245L, 0 to 50 mc.
 f_2 : 0 to 1 mc in single period, 0 to 300 kc in multiple period; periods averaged: 1 to 10^3 in decade steps.
Accuracy: ± 1 count of f_1 , \pm trigger error of f_1 . f_1 is the frequency applied to the counting binaries (enters Time Base Ext. jack); f_2 is the frequency applied to the decade dividers (enters Signal Input jack).
Reads In: Dimensionless; positioned decimal point.
Self Check: Period Average Self Check above applies.

Scaling

Frequency Range: 5243L, 0 to 20 mc; 5245L, 0 to 50 mc.
Factor: By decades up to 10^6 for 5243L, 10^8 for 5245L; switch selected on rear panel.
Input: Front panel, Signal Input.
Output: Rear panel, in place of time base output frequencies.

Time Base

Frequency (internal): 1 mc.
Stability: Aging rate, less than ± 3 parts in 10^9 per 24 hours.
As a function of temperature, less than ± 2 parts in 10^{10} per $^\circ\text{C}$ from -20°C to $+55^\circ\text{C}$. As a function of line voltage, less than ± 5 parts in 10^{10} for $\pm 10\%$ change in line voltage from 115 v to 230 v rms. Short term, less than ± 5 parts in 10^{10} peak-to-peak with measurement averaging time of one second (constant environment and line voltage).
Adjustment: Fine frequency adjustments (covering a range of approximately 4 parts in 10^5) and medium frequency adjustments (covering a range of approximately 1 part in 10^6) are available

from the front panel through the plug-in hole. Coarse frequency adjustment (covering a range of approximately 1 part in 10^3) is available at the rear of the instrument.

Output Frequencies (rear panel): 0.1 cps to 10 mc in decade steps; switch selected on rear panel; all frequencies available in manual function without interruption at reset; 10 kc to 10 mc available continuously in all functions; 1 kc available continuously for all functions except 100K period average; stability same as internal time base; 5 volt p-p rectangular wave with 1000-ohm source impedance at 1 mc and lower; 1-volt rms sine wave with 1000-ohm source impedance at 10 mc.

Output Frequencies (front panel): 0.1 cps to 1 mc in decade steps; selected by Time Base switch; availability as defined under Output Frequencies above; stability same as internal time base; 1 volt peak-to-peak, ac coupled.

External Standard Frequency: 1 mc, 1 volt rms into 1000 ohms required at rear panel BNC connector.

General

Plug-in Capabilities: The 5243L and 5245L accept plug-in Models 5251A, 5253A Frequency Converters, 5261A Video Amplifier and 5262A Time Interval Unit (see page 130).

Registration: 8 digits in-line with Nixie® Tubes and display storage; 99,999,999 maximum display; total width of 8 digit display including illuminated units annunciator and auto-positioned decimal point does not exceed 7 inches.

Sample Rate: Time following a gate closing during which the gate may not be reopened is continuously variable in the frequency function from approximately 0.1 sec to 5 seconds, independent of gate time; display of a single measurement can be held indefinitely.

Input: Maximum sensitivity, 100 mv, rms. Coupling, ac or dc, separate BNC connectors. Attenuation, step attenuator provides ranges of 0.1, 1, and 10 volts. Impedance, 100K per volt (10K at 100 mv); approximately 40 pf on 0.1 volt range, 15 pf on 1- and 10-volt ranges. Overload, 50 volts rms tolerable on 0.1-volt range; 150 volts rms on 1-volt range; 500 volts rms on 10-volt range; ac coupling capacitance, 1 μ f, 600 volts.

Operating Temperature Range: -20°C to $+65^\circ\text{C}$.

Connectors: BNC type except for remote programming and BCD output.

Output: Four-line BCD code output with assigned weights of 1-2-2-4 ("1" state positive with respect to "0" state). This output includes decimal point position and measurement units, suitable for systems use or for output devices such as hp Model 562A Digital Recorder (pages 146, 147), 580A, 581A Digital-to-Analog Converters (page 149). Impedance is 100K each line with "0" state level approximately -8 v, "1" state level approximately $+18$ v. Reference levels: approximately $+17$ v, 350-ohm source; approximately -6.5 v, 1000-ohm source; print command step, $+13$ v to 0 v, dc coupled; hold-off requirement, $+15$ v (min.), $+25$ v (max.) from chassis ground (1000-ohm source).

Remote Operation: All functions which may be programmed from the front panel controls (in normal use) may be programmed from a remote location except for the Sample Rate as defined above and the sensitivity control setting. The instrument provides (through rear panel connectors) all voltages necessary for remote control. The programming voltages for Time Base and Function are low level, -15 v dc at 5 ma per gate. Control may also be achieved by using an external -15 -volt dc supply. The position of the decimal point and measurements unit may be correctly illuminated from a remote location using $+170$ volts dc from internal or external supply.

Power: 115 or 230 volts $\pm 10\%$, 50 to 60 cps; approx. 80 watts.

Dimensions: $16\frac{3}{4}$ " wide, $5\frac{1}{2}$ " high including plug-in, $18\frac{3}{8}$ " deep. Hardware furnished converts unit to a 19 " wide by $5\frac{1}{4}$ " high rack mount.

Weight: Net 32 lbs. Shipping 48 lbs.

Accessories Furnished: hp 10503A Cable Assembly, male BNC to male BNC, 48" long. Detachable Power Cord, $7\frac{1}{2}$ " long, NEMA plug. Circuit Board Extender.

Price: hp 5243L, \$2950; hp 5245L, \$3250.

Specifications, 5242L, 5244L

Frequency Measurements

Range: 5242L, 0 to 20 mc; 5244L, 0 to 50 mc.
Gate Time: 1 μ sec to 10 seconds in decade steps.
Accuracy: ± 1 count \pm time base accuracy.

Reads In: KC or mc with positioned decimal point; units annunciator in line with digital display.

Self Check: Counts 1 mc for the gate time chosen by the time base selector switch.

Period Average Measurements

Range: Single period: 0 to 1 mc; multiple period: 0 to 300 kc.
Periods Averaged: 1 period to 10^3 periods in decade steps.

Accuracy: ± 1 count \pm time base accuracy \pm trigger error¹.
Frequency Counted: Single Period: 10^6 to 1 cps in decade steps; multiple period: 10^3 , 10^2 , or 10^1 .

Reads In: Sec, msec, μ sec, with positioned decimal point; units annunciator in line with digital display.

Self Check: Gate time is 10 μ sec to 1 sec (periods averaged of 100 kc); counts 100 kc from time base.

Ratio Measurements

Displays: (f_1/f_2) times period multiplier.

Range: f_1 : 5242L, 0 to 20 mc; 5244L, 0 to 50 mc. f_2 : 0 to 1 mc in single period, 0 to 300 kc in multiple period; periods averaged 1 to 10^3 in decade steps.

Sensitivity: $f_1 = 1$ v rms, 2500 ohms (100 cps and above), $f_2 = 0.1$ v rms, 100K per volt.

Accuracy: ± 1 count of $f_1 \pm$ trigger error¹ of f_2 . f_1 is frequency applied to counting binaries (enters Time Base Ext. jack), f_2 is frequency applied to decade dividers (enters Signal Input jack).

Reads In: Dimensionless; positioned decimal point for number of periods averaged.

Self Check: Period Average Self Check above applies.

Time Base

Frequency (Internal): 1 mc.

Stability: Aging rate, less than ± 2 parts in 10^7 per month. As a function of temperature, less than ± 2 parts in 10^8 ($+10^\circ$ to 50°C); ± 20 parts in 10^8 (-20° to $+65^\circ\text{C}$). As a function of line voltage, less than ± 1 part in 10^7 for $\pm 10\%$ change in line voltage from 115 v or 230 v rms².

Output Frequencies (front panel): 0.1 cps to 1 mc in decade steps; selected by Time Base switch.

General

Registration: 7 digits in-line with Nixie Tubes and display storage; 9,999,999 maximum display.

Sample Rate: Time following a gate closing during which the gate may not be reopened is continuously variable in the frequency function from approx. 0.1 sec to 5 sec, independent of gate time; display can be held indefinitely.

Input: Maximum sensitivity, 100 mv, rms. Coupling, ac or dc, separate BNC connectors. Attenuation, step attenuator provides ranges of 0.1, 1, and 10 volts. Impedance, 100K per volt (10K at 100 mv); approximately 40 pf on 0.1 volt range, 15 pf on 1- and 10-volt ranges. Overload, diode clamps protect input circuit up to 50 volts rms on 0.1-volt range; 150 volts rms on 1-volt range; 500 volts rms on 10-volt range; ac coupling capacitance, 1 μ f, 600 volts.

Operating Temperature Range: -20°C to $+65^\circ\text{C}$.

Connectors: BNC type except for BCD output.

Output: 4-line BCD, "1" state positive. "0" state level: -8 v "1" state level: $+18$ v. Impedance: 100K, each line. Reference levels: Approximately $+17$ v, 350-ohm source; approximately -6.5 v, 1000-ohm source.

Print Command: $+13$ v to 0 v step, dc coupled.

Hold-off Requirement: $+15$ v min., $+25$ v max. from chassis ground (1000-ohm source).

Power: 115 or 230 v $\pm 10\%$, 50 to 60 cps, approx. 80 w.

Dimensions: $16\frac{3}{4}$ " wide, $5\frac{1}{2}$ " high, $18\frac{3}{8}$ " deep. Hardware furnished converts unit to a 19 " wide x $5\frac{1}{4}$ " high rack mount, $16\frac{3}{8}$ " deep behind panel.

Weight: Net 29 lbs. Shipping 48 lbs.

Accessories Furnished: hp 10503A Cable, 4' long, male BNC connectors. Detachable Power Cord, $7\frac{1}{2}$ " long, NEMA plug. Circuit Board Extender.

Price: hp 5242L, hp 5244L, prices on request.

¹Trigger error for sine wave input is $\pm \frac{0.3\% \text{ of one period}}{\text{periods averaged}}$ for signals with 40 db signal to noise ratio.

²After 72 hours of continuous operation.

³The crystal time base used in the hp 5243L, 5245L is optional at extra cost.

Data subject to change without notice.

hp 5251A, 5253A, 5261A, 5262A COUNTER PLUG-IN UNITS

Increase Versatility of hp 5243L, 5245L Electronic Counters

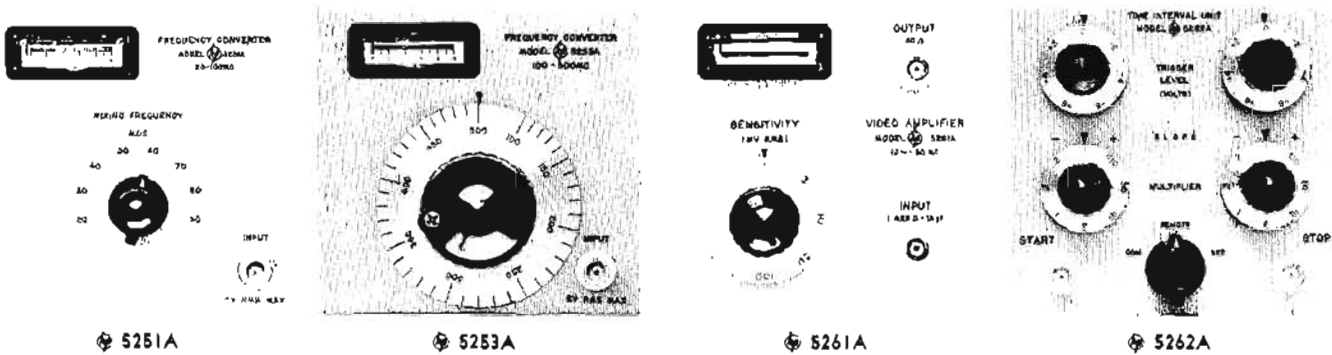

hp 5251A Frequency Converter

The Model 5251A Frequency Converter plugs directly into the front panel of the hp 5243L and 5245L (see pages 128 and 129) to extend measuring capability to 100 mc. The stability and accuracy of the basic counter is retained because the converter uses a multiple of the crystal oscillator frequency from the counter to beat with the signal to be measured.

The basic measurement ranges of the counter also are retained with the converter installed. Measurements to 20 mc (5243L) or 50 mc (5245L) are obtained simply by moving the counter sensitivity control off the "plug-in" position and connecting the input signal directly to the counter input.

Specifications

- Range:** As converter for 5243L or 5245L counters, 20 mc to 100 mc using mixing frequencies of 20 mc to 90 mc in 10 mc steps.
- Accuracy:** Retains accuracy of 5243L and 5245L counters.
- Registration:** First place indicated on converter switch, remainder displayed by counter.
- Input Voltage:** 50 mv rms to 1 volt rms for optimum performance under worst-case conditions; typical signal dropout level with hp 5243L or 5245L is 20 mv rms.
- Overload:** ac signals in excess of 2 volts rms may damage the instrument; up to ± 100 volts dc is tolerable.
- Input Impedance:** Approximately 50 ohms.
- Level Indicator:** Meter aids frequency selection; indicates usable voltage level.
- Weight:** Net 2½ lbs. Shipping 7 lbs.
- Price:** \$300.

hp 5253A Frequency Converter

Model 5253A Frequency Converter extends the measuring capability of the 5243L or 5245L to 512 mc. Operating on the same principle as the 5251A Frequency Converter, it retains the basic stability and accuracy of the counter. It operates from 88 to 512 mc as a frequency converter, although meas-

urements to 20 mc (5243L) or 50 mc (5245L) may be made directly.

Specifications

- Range:** As converter for 5243L or 5245L counters, 88 mc to 512 mc, using mixing frequencies of 100 mc to 500 mc in 10 mc steps.
- Accuracy:** Retains accuracy of 5243L or 5245L counters.
- Input Voltage:** 50 mv to 1 v rms for optimum operation under worst-case conditions. Typical signal dropout level (with hp 5243L or 5245L) is 20 mv rms.
- Input Impedance:** Approximately 50 ohms.
- Overload:** Signals in excess of 2 v rms may damage the converter; up to ± 100 v dc is tolerable.
- Level Indicator:** Meter aids frequency selection; indicates acceptable voltage level.
- Registration:** Counter display is added to or subtracted from converter dial reading depending on whether the mixing frequency is below or above the measured frequency.
- Weight:** Net 5 lbs. Shipping 9 lbs.
- Accessory Furnished:** hp 10503A Cable, 4 feet long, male BNC connectors.
- Price:** \$500.

hp 5261A Video Amplifier

The 5261A Video Amplifier plugs into the 5243L or 5245L counters to increase their sensitivity to 1 millivolt rms over the range from 10 cps to 20 or 50 mc. An input signal level meter is provided to assure that the input signal is adequate to operate the counter and to guard against errors which might result from signal distortion through amplifier overload. The plug-in also provides an output jack for monitoring the unknown voltage being measured.

Specifications

- Bandwidth:** 10 cps to 50 mc.
- Maximum Sensitivity:** 1 mv rms.
- Input Impedance:** Approximately 1 megohm, 15 pf shunt. hp 10003A Probe increases impedance to 10 megohms, 10 pf shunt.
- Attenuator Ranges:** 1, 3, 10, 30 and 100 mv rms.
- Maximum Input:** 300 mv for proper operation.
- Overload:** 5 v rms 100 v dc.

TIME INTERVAL COUNTER

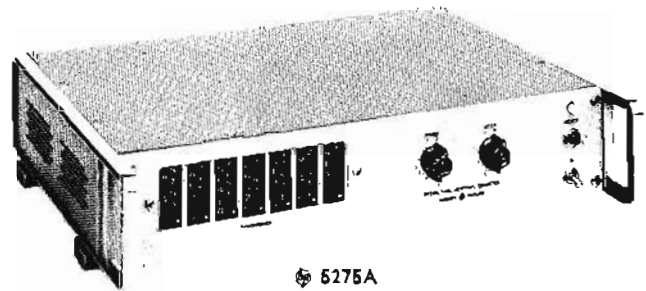

Monitor: Meter shows when the signal level is acceptable to the counter.

Accuracy: Retains accuracy of 5243L or 5245L Electronic Counter.

Auxiliary Output: Separate BNC front panel output for oscilloscope monitoring or for driving external equipment: 50 ohm source impedance. On amplifier's most sensitive attenuator range, 1 mv rms at input results in at least 100 mv rms at auxiliary output into 50 ohm load. Max. undistorted output is 300 mv rms into 50 ohm load.

Accessory Furnished: hp 10507A Low Microphonic 50-Ohm Cable, 4' long, BNC connectors.

Accessories Available: hp 10003A 10:1 Divider Probe 10 pf shunt, 600 v max., \$30; hp 10100A 50-ohm Feed-thru Termination, \$15.

Weight: Net 2 lbs. Shipping 6 lbs.

Power: Supplied by 5243L or 5245L Electronic Counter.

Price: hp 5261A, \$325.

hp 5262A Time Interval Unit

This plug-in converts the 5243L or 5245L into an accurate time interval counter with a resolution of 0.1 microsecond. It permits measurement of pulse length, pulse spacing and time between electrical events. Time is read directly on the counter with the units and decimal indicated. Counter time base accuracy is retained. Further, the 5262A can be used as an amplitude discriminator for the counter so that only signals meeting the requirements set by the trigger level controls are counted. In this mode of operation the frequency range is 0 to 2 mc.

Specifications

Range: 1 μ sec to 10^8 sec.

Accuracy (pulse): ± 1 period of standard frequency counted \pm time base accuracy.

Registration: On 5243L or 5245L counters.

Input Voltage: 0.3 volt, peak-to-peak, minimum, direct coupled input.

Input Impedance and Overload:

Multiplier	Input Impedance		Overload
	Resistance	Capacitance	
x0.1	10K	80 pf	± 150 v rms ± 150 v peak
x0.2	10K	80 pf	
x0.3	30K	40 pf	
x1	100K	20 pf	± 250 v rms ± 250 v peak
x3	300K	20 pf	
x10	1 meg	20 pf	± 250 v peak
x30	3 meg	20 pf	
x700	10 meg	20 pf	

Start Stop: Separate or common channels.

Trigger Slope: Positive or negative on Start and Stop channels, independently selected.

Trigger Amplitude: Both channels continuously adjustable from -250 v to +250 v.

Frequency Range of 5262A used as input signal discriminator: 0 to 2 mc.

Standard Frequency Counted: 10^7 to 1 cps in decades from 5243L/5245L, or externally applied frequency.

Markers: Separate output voltage steps, 0.5 volts peak-to-peak from source impedance of approximately 7K, 100 pf; available at rear panel of 5243L with negative step coincident with trigger points on input waveforms for positive slope and positive step coincident for negative slope.

Reads In: μ s, ms, sec with measurements unit indicated and decimal point positioned.

Accessories Furnished: hp 10503A Cable Assembly, male BNC to male BNC, 4' long.

Weight: Net 2 1/2 lbs. Shipping 9 lbs.

Price: \$300.

Data subject to change without notice.

The Model 5275A permits time interval measurements with 10 nanosecond resolution, providing information previously unavailable in digital form. Range is 10 nanoseconds to 0.1 second, and counted frequency is 100 mc, obtained from an external 1 mc standard by a 100-to-1 multiplying circuit within the counter.

The 5275A is ideally suited for precise digital measurements of short time intervals between events that can be represented by suitable electrical pulses. Applications for this instrument include the measurement of explosive burning rates, speed and acceleration timing of test vehicles in free-flight wind tunnels and nuclear measurements of various kinds.

Standard features included in the 5275A are remote reset, rear-mounted trigger terminals and 4-line BCD output. (The hp 562A Digital Recorder or hp 580A, 581A Digital-to-Analog Converter are compatible with the BCD output from the 5275A.) For system installation a Model 101A 1 MC Oscillator (see page 156) can supply the time base for as many as twenty 5275A counters.

Specifications

Range: 10 nsec to 0.1 sec.

Resolution: 10 nsec.

Accuracy: ± 10 nsec \pm time base accuracy.

Time Base Input: (hp 101A Oscillator recommended).

Frequency: 1 mc.

Amplitude: 1 v rms into 1000 ohms.

Stability: Compatible with measurement needs.

Registration: 7 places, digital, neon columns.

Reads In: Microseconds, with decimal point.

Start and Stop Trigger Input: Separate channels.

Input Impedance: 50 ohms.

Minimum Trigger Pulse Requirements: 3 v peak, 0.5 v/nsec rise time, 5 nsec width.

Trigger Polarity: Selectable, positive or negative.

Reset: Manual, or remote using rear terminals.

Standard Frequency Counted: 100 mc.

Output: 4-line BCD (1-2-2-4).

"0" state: -8 volts.

"1" state: +18 volts.

Impedance: 100K, each line.

Print Command: Step from -6 to +13 volts, dc coupled, 2000 ohm source.

Hold-off Requirements: Any voltage from ground to +12 volts, inclusive.

External Reset: -13 volt pulse, 30 μ sec minimum duration.

Operating Temperature Range: -20°C to +65°C.

Power Requirements: 115 or 230 volts $\pm 10\%$, 50 to 60 cps, 50 watts.

Dimensions: 16 3/4" wide, 3 1/2" high, 11 1/2" deep.

Weight: Net 15 lbs. Shipping 21 lbs.

Accessories Furnished: Two 10503A Cables, 4 ft. long, male BNC connectors; rack mount hardware.

Price: \$2750.

hp 5214L PRESET COUNTER

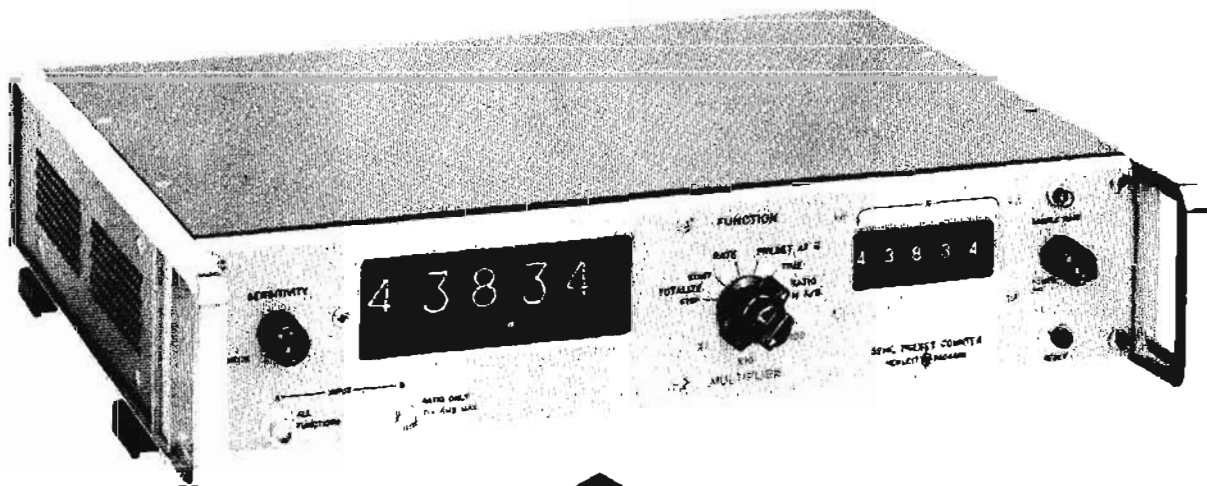

NEW IN THIS
CATALOG

Advantages:

- Adjustable gate time allows readout in practical units
- Display storage
- BCD output for recording, data processing
- Rack mounts in just 3½ inches
- Gate time adjustable in 10 μ sec, 100 μ sec and 1 msec steps

Uses:

- Frequency and rate measurement
- Measure period and multiple period
- Measure ratio in the form $\frac{A}{B} N \times \text{Multiplier}$
- Measure time for N events
- High speed batch counting and control
- Preset counting

Model 5214L Preset Counter is one of the most versatile electronic counters ever produced. It not only measures frequency and period and totalizes, as do most universal electronic counters, but the 5214L also: measures N, 10N, or 100N periods; measures ratio; measures normalized ratio; measures time for N events to occur; counts N, 10N or 100N events giving an output pulse at the start and end of the count.

In these measurements, N may be set to any integer from 1 to 100,000; N = 100,000 is obtained when all the N switches are set to zero.

Such versatility is achieved by using two sets of decades: one set registers the signal being counted, the other, which may be preset to any integer from 1 to 100,000, controls the gate. Provision has been made so that the number N can be remotely programmed. Separate output signals are also available to operate external equipment whenever the gate opens or closes. Self-check provisions, operable from the front panel, are incorporated for the rate, time, preset at N and ratio functions. Also on the front panel are the input sensitivity control, sample rate control, manual reset button, gate lamp, N "preset" switches and input connectors.

Rate Measurement

In rate measurements, the gate, through which the measured signal is passed, is controlled by the time base, the preset decades and the Multiplier. The preset decades may be set to keep the gate open for N cycles of the input frequency from the time base (N = 1 to N = 100,000). If the internal 100 kc time base is connected directly to the preset decades (Multiplier at x1), the gate time may be set from 10 μ sec to 1 sec in 10- μ sec steps. Setting the Multiplier to x10 or x100 divides the time base frequency by 10 or 100 respectively, so that gate time may be set in 100 μ sec or 1 msec steps as well.

Being able to select gate time allows you to normalize readings or to convert frequencies into practical units. For instance, if a tachometer generator, which produces 100 pulses per revolution, is connected to a rotating shaft, you can set the gate to 10.000 msec (0.01 sec) and measure rps directly or you can set the gate for 600.00 msec (0.6 sec) and measure rpm.

The long gate times that are available (up to 100 seconds) allow you to measure low frequencies or register the least significant digits of an input signal better to observe small variations of rate.

Ratio

Model 5214L measures ratio over a wide range of frequencies and with a wide choice of normalizing factors. The signal connected to input B goes through the Multiplier and the preset decades and controls the gate time; the signal connected to input A goes to the readout decades. Consequently, signal A is counted for N (times the Multiplier setting) cycles of signal B.

The number displayed by the readout decades is $N \times A/B \times \text{Multiplier}$, where A is the frequency of the signal connected to input A, and B is the frequency of the signal connected to input B. Preset numbers from 1 to 100,000 can be chosen in steps of 1, from 10 to 10^6 in steps of 10 and from 10^2 to 10^7 in steps of 100. Hence, input B can be used as an external time base input for extending gate time or for normalizing an input signal so that percent change of input signal A may be read directly.

Time Measurement

Model 5214L measures the time in milliseconds for N events to occur. The measurement may be made in increments of 0.01, 0.1 or 1 msec by setting the Multiplier to x1, x10, or x100 respectively.

The ability to choose the number of input cycles measured and to choose time increments of 0.01, 0.1 or 1 msec allows the operator to achieve the greatest accuracy possible, or to obtain a required accuracy in the shortest measurement time.

Preset Counting

When the function switch is set to Preset at N, the 5214L counts N events, 10N events, or 100N events depending on the setting of the Multiplier. This feature is useful in batching; the gate signal can be used to control external equipment. An output pulse occurs at the beginning and at the end of the preset count for use with external equipment.

Other Features

All *hp* solid state electronic counters are arranged for read-out storage which provides a continuous display of the most recent measurement. This display is held even while the instrument is gated for a new count. If the new count differs from the stored count, the display will shift to the new reading directly. Where desirable, the storage feature may be disabled by a rear panel switch.

The 5214L provides a four-line BCD output with assigned weights of 1-2-2-4 ("1" state positive with respect to "0" state). This output is suitable for systems use or for output devices such as *hp* Model 562A Digital Recorder (page 146), or the Model 580A or 581A Digital-to-Analog Converters (page 149).

Specifications

Functions

- Totalize (input A):**
Range: 2 cps to 300 kc.
Sensitivity: 0.1 volt rms sine wave; 1 volt negative pulse, 1 μ sec minimum width.
Gate Time: Manual control.
Input Impedance: 1 megohm, 50 pf shunt.
Capacity: 99,999 counts x Multiplier (1, 10 or 100).
Check: Counts 1 kc, 100 cps or 10 cps.
- Rate (input A):**
Range: 2 cps to 300 kc.
Sensitivity: 0.1 volt rms sine wave; 1 volt negative pulse, 1 μ sec minimum width.
Gate Time: 10 μ sec to 1 sec in 10- μ sec steps; 100 μ sec to 10 sec in 100- μ sec steps; 1 msec to 100 sec in 1-msec steps.
Accuracy: ± 1 count \pm time base accuracy.

- Input Impedance: 1 megohm, 50 pf shunt.
Check: Counts interval 100 kc for gate time.
- Preset at N (input A):**
Input Frequency Range: 2 cps to 100 kc.
Sensitivity: 0.1 volt rms sine wave; 1 volt negative pulse, 1 μ sec minimum width.
Preset Range: 1 to 10^5 in steps of one, 10 to 10^6 in steps of ten, 100 to 10^7 in steps of 100.
Input Impedance: 1 megohm, 50 pf shunt.
Outputs: Positive pulse approximately 10 volts high and 5 μ sec wide at gate opening and gate closing.
Check: 100 kc counted, reads N x Multiplier.
- Time (input A):**
Input Frequency Range: 2 cps to 100 kc.
Sensitivity: 0.1 volt rms sine wave; 1 volt negative pulse, 1 μ sec minimum width.
Reads: Time for N events in msec.
Time Base: 10 μ sec, 0.1 msec, or 1 msec.
Input Impedance: 1 megohm, 50 pf shunt.
Accuracy: ± 1 count \pm time base accuracy \pm trigger error*.
Check: 100 kc counted, reads time in msec for N cycles.
- Ratio (input A and B):**
Input A:
Frequency Range: 2 cps to 300 kc.
Sensitivity: 0.1 volt rms sine wave; 1 volt negative pulse, 1 μ sec minimum width.
Input Impedance: 1 megohm, 50 pf shunt.
- Input B:
Frequency Range: 2 cps to 100 kc on x1 (2 cps to 300 kc on x10 and x100).
Sensitivity: 0.1 volt to 10 volts rms.
Input Impedance: 1 megohm, 50 pf shunt.
Reads: N x A/B x Multiplier.
Accuracy: ± 1 count.
Check: Reads N x Multiplier (requires an input to B).

Time Base

- Internal: Aging Rate: ± 2 parts in 10^4 /week. Temperature: ± 20 parts in $10^\circ + 15^\circ\text{C}$ to $+ 35^\circ\text{C}$, ± 100 parts in $10^\circ - 20^\circ\text{C}$ to $+ 65^\circ\text{C}$.
Line Voltage: 1 part in 10^4 for $\pm 10\%$ line voltage.

Printer Output

- Output: 4-line BCD (1-2-2-4).
Impedance: 100K each line.
"0" State Level: Approximately - 28 volts.
"1" State Level: - 2 volts.
Reference Levels: Approximately - 2.4 volts, 350-ohm source impedance and - 26.9 volts, 1000-ohm source.
Print Command: Step from - 29 volts to - 1 volt from 2700-ohm source in series with 1000 pf.
Hold-off Requirements: Chassis ground to + 12 volts maximum.

General

- Registration: 5 long-life digital display tubes with display storage.
Sample Rate: Sample rate control determines length of time after gate closure before gate can be reopened. Adjustable from 0.2 second (minimum) to at least 5 seconds (maximum). With counter in Rate, it is independent of gate time; display can be held indefinitely.
Operating Temperature: - 20 $^\circ$ to + 65 $^\circ\text{C}$.
Remote Operation: Number "N" can be remotely preset by appropriate contact closure.
Dimensions: 16 $\frac{3}{4}$ " wide, 3-13/16" high, 13 $\frac{1}{4}$ " deep. Quickly converts to rack mount 19" wide, 3 $\frac{1}{2}$ " high, 11 $\frac{3}{4}$ " deep behind mounting surface.
Weight: Net, 15 lbs.
Power: 115 or 230 v $\pm 10\%$, 50 to 60 cps, 35 watts (line frequency limit imposed by fan; for operation up to ambient of 50 $^\circ\text{C}$, line frequency can be 50 to 1000 cps).
Accessories Provided: Two 10503A cables, 4 feet long, BNC connectors, circuit board extender, detachable power cord.
Price: \$1475.

*Trigger error (sine wave) = $\frac{0.3\% \text{ of one period}}{\text{number of periods}}$ for 40 db signal-to-noise ratio. Trigger error decreases with increased signal amplitude and slope.

Data subject to change without notice.

hp 521 SERIES INDUSTRIAL COUNTERS

Low Cost, Flexible, Easy-To-Use; 1 CPS to 1.2 MC!

The Hewlett-Packard 521 Series Electronic Counters are rugged, versatile instruments for production, processing and laboratory applications.

Ⓟ 521 Series Counters measure frequency and speed, and count events occurring at random within a selected period of time. With proper transducers converting mechanical into electrical phenomena, the instruments measure weight, pres-

sure, temperature and other quantities which can be related to frequency.

Digital Recorder Operation

Versatile 521 Series Counters may be adapted easily to operation of Ⓟ 560A or 561B Digital Recorders (see pages 144, 145) with the installation of a kit. These kits can be installed by the Ⓟ factory before shipment (slight extra charge), or can be purchased for field installation later.

Model	521A	521C	521D	521E	521G
Maximum Frequency	120 KC*	120 KC*	120 KC*	120 KC*	1.2 MC
Count Presentation	4 places, neon	5 places, neon	4 places, in-line	5 places, in-line	5 places, neon
Gate Time	0.1, 1 sec	0.1, 1, 10 sec	0.1, 1 sec	0.1, 1, 10 sec	0.1, 1 sec
Power	160 watts, 170 w with Xtal time base	170 watts	160 watts, 170 w with Xtal time base	170 watts	160 watts, 170 w with Xtal time base
Size (cabinet)	9¾" W, 15¼" H, 14½" D	9¾" W, 15¼" H, 14¼" D	9¾" W, 15¼" H, 15½" D	9¾" W, 15¼" H, 15½" D	9¾" W, 15¼" H, 14¼" D
Price (cabinet)	\$475.00	\$650.00	\$750.00	\$950.00	\$700.00
(rack mount)	480.00	655.00	755.00	955.00	705.00

*220 KC optional, add \$35.00.

Add \$45.00 for 560 or 561 Digital Recorder operation (561 with 521D/E only).

Crystal Time Base, standard equipment in 521C and 521E, optional for 521A, 521D and 521G, add \$100.00.

BCD output (1-2-2-4; "1" state positive) available at extra cost for use with the Ⓟ 562 Digital Recorder, Ⓟ 580A, 581A Digital-to-Analog Converter and Dymec equipment.

FOR ALL MODELS

Accuracy: ± 1 count \pm time base accuracy (approx. $\pm 0.1\%$ with line frequency, $\pm 0.01\%$ with Crystal Time Base).

Input Requirements: 0.2 v rms minimum or output from 1P41 Phototube (or equal). Phototube bias provided at "PHOTOTUBE" jack. ½ v rms required at frequencies above 120 KC with 220 KC option. Attenuator reduces sensitivity to 100 v rms to overcome noise.

Input Impedance: Approximately 1 megohm, 50 pf shunt (500,000 ohms on "PHOTOTUBE" jack).

Manual Gate: Controlled by "Count" switch or external contacts.

Display Time: Variable from gate time to approximately 15 seconds; or display can be held indefinitely.

Reset to Zero: Automatic or manual.

Reads In: Directly in cps or rps or in rps or rpm with Ⓟ 506A or 508A Tachometer Accessories.

Self Check: Counts 50/60 cps line frequency for any selected gate time. 10 KC with Crystal Time Base.

Line Voltage: 115 or 230 v $\pm 10\%$, 50 or 60 cps.

External Standard: Can be operated from any integral multiple of 10 cps, 10 cps to 100 cps.

Size: Rack Mount: 19" wide, 8¾" high, 14" deep behind panel.

Weight: Cabinet Mount: Net 28 lbs. Shipping 41 lbs. Rack Mount: Net 28 lbs. Shipping 35 lbs.

Accessories Provided: Ⓟ 10501A Cable Assembly, 44" RG-58/U cable terminated one end with UG-88/U Type BNC connector.

Accessories Available: Ⓟ Model 506A Optical Tachometer Pickup, \$150.00. Ⓟ Model 508 Series Tachometer Generators, \$125.00 each.

Data subject to change without notice.



Model 521D



Model 521C

hp 522B ELECTRONIC COUNTER

Versatile, Low Cost Precision Counter Covers 10 CPS to 120 KC

The all-purpose hp 522B Counter measures frequency, period and time interval over a broad frequency range. Results are displayed automatically in direct reading form—cps, kc, seconds or milliseconds. Reliable and accurate readings make measurement quick and convenient, even for unskilled personnel. The counter can be supplied with digital recorder output for a small additional charge.

Specifications

Frequency Measurement:

Range: 10 cps to 120 kc (220 kc optional).
Accuracy: ± 1 count \pm time base accuracy.
Stability: $1/10^5$ /week or better.
Input Requirements: 0.2 volt rms minimum. Input is direct-coupled.
($1/2$ v rms above 120 kc with 220 kc option.)
Input Impedance: Approx. 1 megohm, 50 pf shunt.
Gate Time: 0.001, 0.01, 0.1, 1, 10 sec. Manual control extends to any multiple of 1 or 10 sec.
Display Time: Variable 0.1 to 10 sec in steps of gate time selected or until manually reset.
Reads In: CPS or kc, decimal point indicated.

Period Measurement:

Range: 0.00001 cps to 10 kc. Output pulse available to actuate trigger circuit for mechanical register.
Accuracy: ± 1 count \pm time base accuracy \pm trigger error*
Input Requirements: 0.2 volt rms minimum. Direct-coupled input.
Input Impedance: Approx. 1 megohm, 50 pf shunt.

Gate Time: One or ten cycles of unknown frequency. May be extended to any number of cycles of unknown frequency lower than 50 cps by manual control.

Std. Freq. Counted: 1, 10, 100 cps; 1, 10, 100 kc; external.

Display Time: Variable from 0.1 to 10 seconds in steps of period being measured or until manually reset.

Reads In: Seconds or msec, decimal point indicated.

Time Interval Measurement:

Range: 10 μ sec to 100,000 seconds (27.8 hrs.).

Accuracy: ± 1 count \pm time base accuracy.

Input Requirements: 1 v peak min. Direct-coupled input.

Input Impedance: Approx. 250,000 ohms, 50 pf shunt.

Start and Stop: Independent or common channels.

Trigger Slope: Pos. or neg. on start and/or stop channels.

Trigger Amplitude: Continuously adjustable on both channels from -100 to +100 volts.

Std. Freq. Counted: Same as for Period Measurement.

Display Time: Same as for Period Measurement.

Reads In: Seconds or msec, decimal point indicated.

General:

Power: 115 or 230 v $\pm 10\%$, 50 to 60 cps, 260 watts.

Dimensions: Cabinet, 20 $3/4$ " wide, 12 $3/4$ " high, 14 $1/4$ " deep. Rack mount, 19" wide, 10 $1/2$ " high, 13 $3/8$ " deep behind panel.

Weight: Net, 50 lbs. Shipping 60 lbs. (cabinet). Net, 43 lbs. Shipping, 57 lbs. (rack mount).

Price: hp 522B, \$915 (cabinet); hp 522BR, \$900 (rack mount).

With staircase output (for 560A operation) specify Option 01, add \$45. For 220 kc operation, specify Option 02, add \$35. BCD output (1-2-2-4) available, price on request.

*Trigger error is $\pm \frac{0.3\% \text{ of one period}}{\text{periods averaged}}$ for signals with 40 db signal to noise ratio.

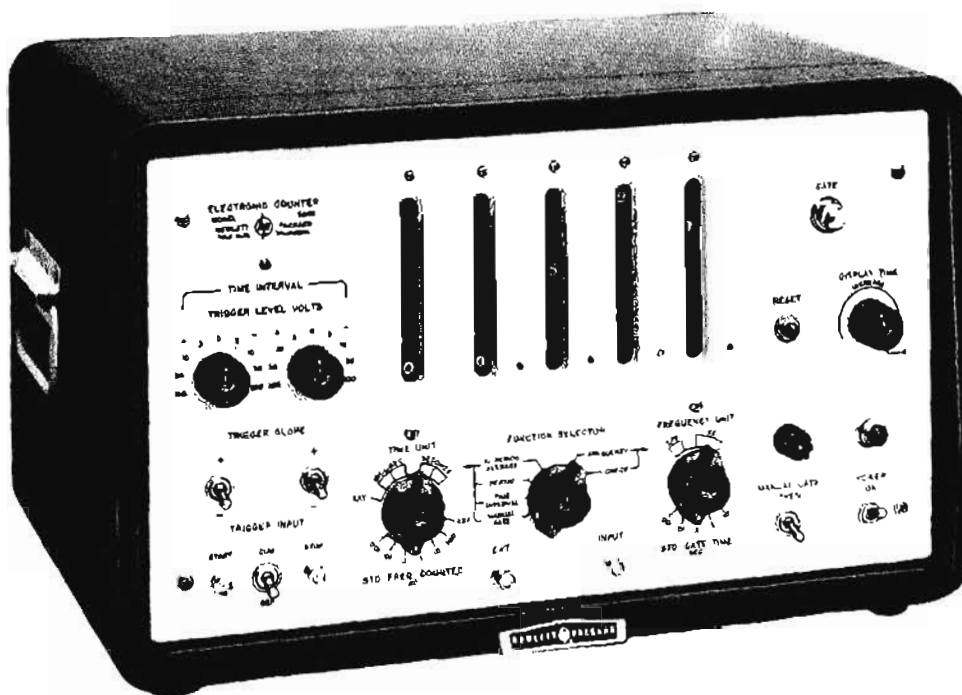

hp 523C,D ELECTRONIC COUNTERS

Measure Period, Time or Frequency, 10 CPS to 1.2 MC

Advantages:

- High sensitivity
- Superior trigger level controls
- Extreme versatility
- High accuracy
- Easy to operate and maintain

Uses:

- Measure frequency
- Count periodic or random pulses
- Measure period, time interval
- High accuracy phase measurements
- Totalize events, measure ratios
- Measure speed, flow rate, other physical variables

High sensitivity and sophisticated trigger level circuitry make the hp 523C and 523D unique among electronic counters. The instruments measure frequency, period, time interval, phase delay, random events and ratios. They also totalize electrical events, periodic or random. The 523C has an in-line display and is available with a 10-line decimal code output, while the 523D has a neon columnar display.

Frequency Measurements

Model 523 Counters measure frequencies from 10 cps to 1.2 mc. Gate times from 0.001 to 10 seconds are selected with a front panel switch. An input attenuator reduces the effect of noise. Also, the Time Interval stop channel can be used so that the only input signals meeting the trigger level and slope settings will be counted.

Period Measurements

Accuracy and resolution of the 523's make possible precise period measurement of power line voltages, low frequency oscillator and signal generator output, test signals used in low frequency filter work and low audio and subsonic signals in general. One cycle may be measured or you may obtain average time per cycle for 10 periods.

Time Interval Measurements

Time interval between any two events which can be represented by electrical pulses can be measured over the range of 1 μ sec to 10^6 seconds. This makes the counters ideal for applications involving pulse length, pulse spacing, ballistic measurements, shutter speeds and relay operating times.

Time intervals are indicated directly in μ sec, milliseconds or seconds as selected by the time unit switch. External frequencies may be counted during the time interval for normalized readings or measurements in the units other than time units. Separate start and stop channels are provided. Trigger output pulses permit intensity modulation of a scope and the triggering of auxiliary equipment.

Phase Measurements

The 523C and 523D measure phase delay in μ sec, msec, second, or in degrees or 0.1 degree by counting an external frequency instead of the internal standard. Special attenuators simplify setting trigger point to zero-axis crossing.

Measurements of Random Events, Totalizing

Their double pulse resolving time of 0.8 μ sec makes these counters well suited to totalizing or measuring the rates of random events.



523C

Pulses at rates from 0 to 1.2×10^6 pps may be totalized for any of the gate times 0.001 to 10 sec or for longer periods by using the manual gate. Events which can be represented by electrical pulses can be totalized to a maximum of 999,999, so long as the minimum time between events is at least 0.8 μ sec.

Ratio Measurements

Ratio measurements may involve any phenomena which can be represented by electrical impulses in the proper frequency range. One signal, f_2 , may be used to open and close the signal gate while another signal, f_1 , is counted. f_1 may be counted for 1 or 10 periods of f_2 , providing the ratio of f_1/f_2 or $10 f_1/f_2$.

Digital Recorder Remote Indicator Operation

An assortment of modification kits are available for factory or field installation to permit use of the 523 counters with digital recorders, digital-to-analog converters, remote indicators, etc.

Specifications

Frequency Measurement:

Range: 10 cps to 1.2 mc.

Accuracy: ± 1 count \pm time base accuracy.

Input Sensitivity: 0.1 v rms, adjustable to 150 v rms max. input.

Input Trigger Levels: Stop channel may be used so that only signals meeting conditions set by trigger level controls are counted. Slope may be + or -, level -300 to +300 volts.

Input Impedance: Approx. 1 megohm, 50 pf shunt.

Gate Time: 0.001, 0.01, 0.1, 1, 10 seconds.

Reads In: Kilocycles; automatic decimal.

Period Measurement:

Range: 0.00001 cps to 100 kc.

Accuracy Measuring Sine Waves: ± 1 count \pm time base accuracy \pm trigger error*.

Input Requirements: 0.1 v rms min., direct coupled.

Input Impedance: Approx. 1 megohm shunted by 50 pf.

Measurement Period: 1 or 10 cycles of unknown.

Standard Frequency Counted: 1 cps to 1 mc in decade steps or externally applied signal, 10 cps to 1.2 mc, 0.1 v rms minimum.

Reads In: Seconds, msec or μ sec. Positioned decimal.

Time Interval Measurement:

Range: 1 μ sec to 10^6 sec.

Accuracy (Pulse Input): ± 1 count \pm time base accuracy.

Input Impedance: Approx. 1 megohm, 50 pf shunt.

Input Requirements: 0.1 v rms minimum. Direct or ac coupled input.

Start and Stop Input: Separate channels with independent controls. Separate or common input.

Start and Stop Marker Output: Separate output pulses, each approximately 5 μ sec duration and -20 v peak, available at rear of instrument for oscilloscope intensity modulation to mark start and stop points on input waveform. May be combined with SEP-COM switch on rear of instrument.

Trigger Slope: Positive or negative on start and stop channels.

Trigger Amplitude: Continuously adjustable on both input channels from -300 to +300 v.

Standard Frequency Counted: 1 cps, 10 cps, 100 cps, 1 kc, 10 kc, 100 kc, 1 mc; external.

Reads In: Seconds, msec or μ sec. Decimal positioned automatically.

Phase Measurement:

Range: 1 cps to 20 kc, dc coupled; 50 cps to 20 kc, ac coupled.

Input Voltage: 5 to 10 v rms, pure sinusoidal signal.

Accuracy: $\pm 0.1^\circ \pm \left(\frac{f_p}{f_c}\right) \times 360^\circ$ where f_c is the counted frequency and f_p the measured frequency.

Ratio Measurement:

Displays f_1/f_2 , or $10 f_1/f_2$, with accuracy of ± 1 count. f_1 : 10 cps to 1.2 mc; f_2 : 0.00001 cps to 100 kc. ($f_1 > f_2$).

Totalize:

Electrical events, periodic or random to 999999 at rates to 1,200,000/sec.

General:

Registration: 523C: Six Nixie® Tubes, single line; 523D: Six decimal places each indicated by lighted numbers.

Stability: 2/1,000,000 per week.

Display Time: Variable from approximately 0.1 to 10 seconds; display can be held until manually reset.

Self-Check: Counts of 100 kc or 1 mc.

Output Frequencies: Secondary standard frequencies available at front panel; 1 cps, 10 cps, 100 cps, 1 kc, 10 kc, rectangular; 100 kc and 1 mc sine wave, 0.5 v p-p. Stability 2/10⁶ per week.

External Standard: 100 kc from external primary standard can be applied to unit for highest accuracy; minimum input, 1 v rms.

Power Supply: 115 or 230 volts $\pm 10\%$, 50 to 60 cps, approx. 350 watts.

Accessories Furnished: 2 hp 10503A Cable Assemblies.

Dimensions: 20½" wide, 11¼" high, 18¾" deep (cabinet); 19" wide, 8¾" high, 16¼" deep behind panel (rack mount).

Weight: Net 48 lbs., shipping 70 lbs. (cabinet). Net 48 lbs., shipping 62 lbs. (rack mount).

Accessories Available: Remote Indicator for 523C, 523CR and interconnecting cable (100' max.), prices on request.

Digital Recorder Kits for field installation: 523D-95A Adapter Kit for operating hp 560A Digital Recorder from 523C or 523D, \$45. 523C-95B Adapter Kit for operating Model 561B Digital Recorder from Model 523C, \$45.

Price: hp Model 523C, \$1575 (cabinet); 523CR, \$1550 (rack mount). hp Model 523D, \$1350 (cabinet); 523DR, \$1325 (rack mount).

Options: 01. Single line decimal code (staircase) for operating hp 560A Digital Recorder, 523D-95A installed, add \$45. 02. 10-line decimal code output for operating hp 561B Digital Recorder or Remote Indicator, 523C, only, (523C-95B installed), add \$45.





4-line BCD output ("1" state positive) available for driving hp 562A Digital Recorder; 580A, 581A Digital-to-Analog Converters; Dymec instruments, or data processing equipment, price on request.

*Trigger error is $\pm \frac{0.3\% \text{ of one period}}{\text{periods averaged}}$ when S/N ratio is 40 db, decreases with increasing signal amplitude and slope.

Data subject to change without notice.

524C,D ELECTRONIC COUNTERS

Measure Frequency to 10.1 MC*
— Time Base Stability 5/10⁸/ Week

Here is the electronic counter that provides extremely versatile frequency, time interval or period measuring coverage. You buy the basic  524C,D Counter with selected  525 or 526 series Plug-In Units covering your exact present requirements; later you can add other inexpensive plug-ins to increase the usefulness of the instrument. Still wider usefulness may be obtained by using the 524C,D in conjunction with  540B Transfer Oscillator for frequency measurements to 12.4 GC, and above (*see page 142*) and  digital recorders for a permanent, printed record of measurements.

Great Versatility



The moderately priced 524C,D gives you more range, simplicity, usefulness and reliability than any group of instruments with comparable range ever offered. With this one all-purpose equipment, you measure transmitter and crystal oscillator frequencies, electrical, electronic and mechanical time intervals, phase angles, pulse lengths and repetition rates or frequency drift. You make high accuracy ballistics time measurements or high resolution tachometry measurements. The instrument also serves as a house frequency standard for many users, with a long-term stability of 5 parts in 10⁸ per week. It is simple to operate and readily used by non-technical personnel.

Basic Counter Details



In the basic 524C Counter (without Plug-In Units) frequency from 10 cps to 10.1 MC is read over 5 selected gate times — 0.001, 0.01, 0.1, 1 and 10 seconds. Display time is variable, counts are automatically reset, and action is repetitive. Low frequencies (below approximately 300 cps) are more accurately measured by determining the period of one or ten cycles. Here the unknown frequency operates the gate and the internal standard frequency is applied to the counter. Thus the duration of a low frequency cycle is measured in time units. A 10-cycle sample may also be taken to improve accuracy. The result is determined automatically and presented in direct reading form with automatic illuminated decimal point.

Digital Recorder Operation

At nominal additional charge, Model 524C or 524D Electronic Counters can be modified to provide the following output signals:

1. A single-line staircase output for operation of the  560A Digital Recorder.
2. A 10-line code decimal output for operation of the  561B Digital Recorder or K05-524C Remote Indicator (524C only).
3. A 4-line (1-2-2-4) binary coded decimal output for connection to  562A Digital Recorder, 580A or 581A Digital to Analog Converters (*see page 149*) or other data processing equipment.

Models 561B and 560A (*pages 144, 145*) and 562A (*pages 146, 147*) are 11-column recorders which are slaves to the counter and print the counter reading at rates up to 5 per second.

*To 12.4 GC with  540B Transfer Oscillator; to 18 GC with  540B and  P932A Harmonic Mixer.

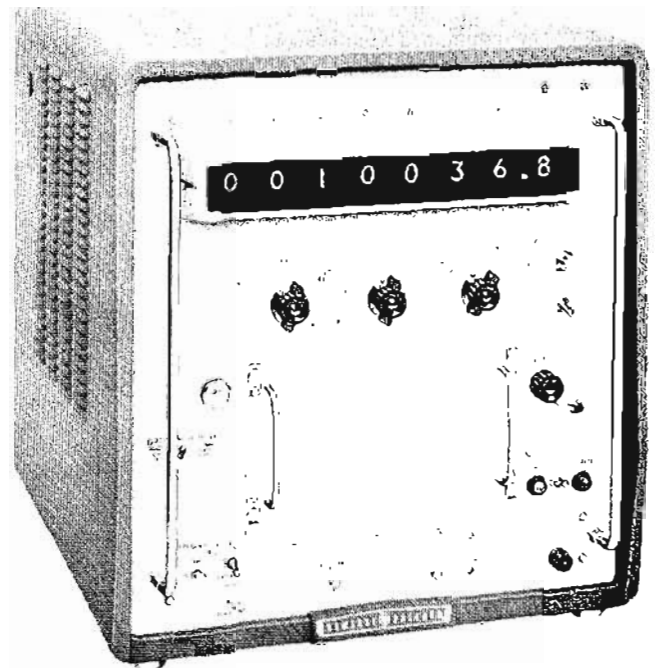

 524C

Advantages:

- Direct, instantaneous automatic readings
- Easily used by non-technical personnel
- Bright, big-numbered readout
- Resolution 0.1 microsecond
- Stability 5/100,000,000/week
- Available for printer operation
- High sensitivity, high impedance
- Extreme reliability
- No calculation or interpolation
- Automatic decimal point
- Highest quality construction
- Military design

Use For:

- Frequency measurements 10 cps to 510 MC*
- Time interval measurements 1 μ sec to 100 days
- Period measurements 0 cps to 100 KC
- Phase angle measurements to 20 KC
- Standard frequency output of 10 cps, 1 KC, 100 KC, 10 MC
- Time and frequency ratios
- High resolution tachometry ballistics measurements

Ⓢ 524D Electronic Counter

Model 524D is identical electrically with the Ⓢ 524C, but has 8-decade numerical readout using the widely accepted Ⓢ neon indicators instead of inline readout. Model 524D offers the same time-saving convenience of direct instantaneous, automatic readings without calculation or interpolation, but is priced slightly lower than the Model 524C.

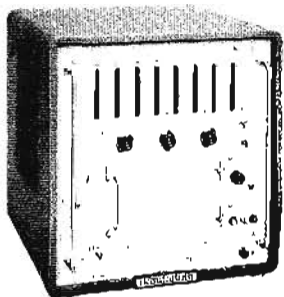

Counter Plug-In Units

Addition of Ⓢ 525 and 526 series Plug-In Units will extend any Ⓢ 524 Counter's frequency range to 510 MC, provide increased sensitivity, and make available uniquely flexible time interval and phase angle measurements.

Ⓢ 525A Frequency Converter. This instrument extends the Counter's 10 MC direct-reading range in decade steps through 100 MC. It maintains counter accuracy throughout the extended range. It provides additional amplification to increase sensitivity. A tuned input circuit simplifies determining the correct frequency range and rejects



harmonics and spurious signals.

Ⓢ 525B Frequency Converter. Similar to 525A, this unit extends the counter's range from 100 MC to 220 MC in 10 MC steps, at the same time preserving the high accuracy of the basic counter. It maintains the same high sensitivity 0.2 volt minimum input throughout its range, and includes a wavemeter for determining the proper frequency decade range.



Ⓢ 525C Frequency Converter. Counter accuracy is extended over the wide range of 100 MC to 510 MC with this heterodyne converter. Sensitivity is 100 mv over its range; it may be used to increase counter sensitivity to 20 mv from 50 KC to 10.1 MC.

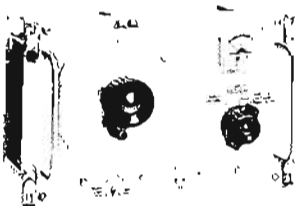

Ⓢ 526A Video Amplifier. This equipment increases the counter's 10 cps-to-10 MC sensitivity to 10 millivolts for frequency measurement at low power levels. A special probe assembly simplifies remote pickup at high impedance levels. An oscilloscope output terminal allows visual monitoring of the input waveform.

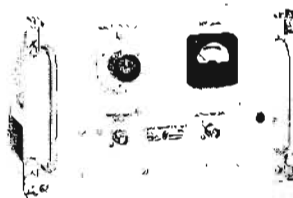

Ⓢ 526B Time Interval Unit. This instrument measures intervals from 1.0 μ sec to 100 days with maximum accuracy of 0.1 μ sec \pm time base accuracy. Intervals are read direct in seconds, milliseconds or microseconds. Start and stop triggering is performed in either common or separate channels, and may be accomplished through the use of positive or negative going waves. Trigger voltage levels are continuously adjustable from - 192 to + 192 volts.

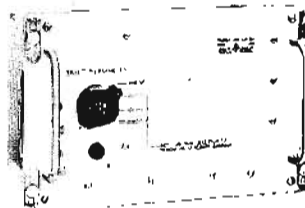
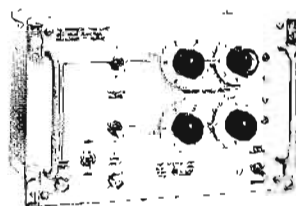

Ⓢ 526C Period Multiplier. This unit allows average measurements of 100, 1000, and 10,000 periods. This insures greater accuracy for midrange frequency measurements.

Ⓢ 526D Phase Unit. Designed for precise phase angle measurements, the Ⓢ 526D covers the range from 1 cps to 20 KC, reading in time units with resolution to 0.1 μ sec. For measurements from 396-404 cps, this unit is designed to give phase angle readings directly in tenths of degrees.

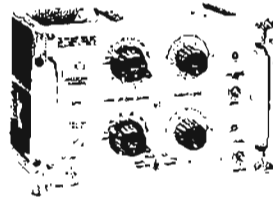

Specifications

Ⓢ 524C,D Electronic Counter

Basic Unit, for Frequency Measurements, 0 cps to 10.1 MC

Frequency Measurement: (without plug-in units).

Range: 10 cps to 10.1 MC.

Gate Time: 0.001, 0.01, 0.1, 1, 10 seconds or manual control.

Accuracy: ± 1 count \pm time base accuracy.

Reads In: Kilocycles; decimal point automatically positioned.

Period Measurement: (without plug-in units).

Range: 0 cps to 100 KC.

Gate Time: 1 or 10 cycles of unknown.

Accuracy: $\pm 0.3\%$ (measurement one period) \pm time base accuracy ± 1 count.*
 $\pm 0.03\%$ (ten-period average) \pm time base accuracy ± 1 count.*

Standard Frequency Counted: 10 cps; 1 or 100 KC; 10 MC, or externally applied frequency.

Reads In: Seconds, milliseconds or microseconds; decimal point automatically positioned.

General:

Registration: 524C, 8 places (Nixie); 524D, 8 numbered columns; 99,999,999 maximum display.

Stability: $3/10^8$ short term; $5/10^8$ per week. May be standardized with external 100 KC or 1 MC primary standard.

Display Time: Variable 0.1 to 10 seconds but not less than gate time. Display can be held indefinitely.

Output Frequencies: Secondary standard frequencies available at front panel: 10 cps, 1 KC rectangular; 100 KC positive pulse; 10 MC sine wave. (Stability as above.)

Self Check: Panel control provides automatic count of internal standard 100 KC and 10 MC frequencies to assure proper operation of counter.

Input Voltage: 1 v rms minimum 1.5 v peak.

Input Impedance: Approx. 1 megohm, 40 pf shunt.

External Standard: 100 KC or 1 MC signal from external primary standard can be applied to unit for highest accuracy. 2 volts rms required. Input impedance, nominal: 56K, 40 pf shunt capacitance.

Power: 115 or 230 v $\pm 10\%$, 50 to 60 cps, 600 watts.

Dimensions: Cabinet Mount: 20" wide, 21 $\frac{1}{4}$ " high, 23 $\frac{1}{2}$ " deep. Rack Mount: 19" wide, 19 $\frac{1}{4}$ " high, 20 $\frac{1}{4}$ " deep.

Weight: Net 118 lbs. Shipping 168 lbs. (cabinet mount). Net 108 lbs. Shipping 172 lbs. (rack mount).

Accessories Furnished: 1 $\text{\textcircled{C}}$ 10503A Cable Assembly.

Accessories Available: $\text{\textcircled{C}}$ 524D-95A Model 560A Digital Recorder Kit for field installation, \$75.00; $\text{\textcircled{C}}$ 524C-95B Model 561B Digital Recorder Kit for field installation (524C/CR only) \$150.00.

Price: $\text{\textcircled{C}}$ 524C (cabinet), \$2,400.00. $\text{\textcircled{C}}$ 524CR (rack mount), \$2,375.00. $\text{\textcircled{C}}$ 524D (cabinet), \$2,150.00. $\text{\textcircled{C}}$ 524DR (rack mount), \$2,125.00.

For $\text{\textcircled{C}}$ 560A recorder operation order Option 01, add \$75.00. For $\text{\textcircled{C}}$ 561B recorder operation (524C/CR only) order Option 02, add \$150.00. BCD output available for $\text{\textcircled{C}}$ 562A recorder or system use, price on request.

$\text{\textcircled{C}}$ 525A Frequency Converter Unit

for Frequency Measurement, 10 cps to 100 MC. Plugged into $\text{\textcircled{C}}$ 524:

Range: As amplifier for counter, 10 cps to 10.1 MC. As converter for counter, 10.1 MC to 100 MC.

Accuracy: Retains accuracy of 524 Counter.

Registration: 8 places; first place indicated on converter selector switch labeled 0, 10, 20 . . . 90; next 7 as indicated by counter.

Input Voltage: 0.1 v rms minimum, 10 cps to 10.1 MC; 10 mv rms minimum, 10.1 MC to 100 MC.

Input Impedance: Approx. 1 megohm shunted by 40 pf, 10 cps to 10 MC; approx. 50 ohms, 10 MC to 100 MC.

Level Control: Tuning eye aids frequency selection; indicates correct voltage level adjustment.

Weight: Net 5 lbs. Shipping 8 lbs.

Price: $\text{\textcircled{C}}$ 525A, \$300.00.

$\text{\textcircled{C}}$ 525B Frequency Converter Unit

for Frequency Measurement, 100 MC to 220 MC. Plugged into $\text{\textcircled{C}}$ 524:

Range: 100 MC to 220 MC.

Accuracy: Retains accuracy of 524 Counter.

Registration: 9 places; first two places indicated on converter selector switch labeled 100, 110, 120 . . . 210, next 7 indicated by counter.

Input Voltage: 0.2 v rms minimum.

Input Impedance: Approximately 50 ohms.

Level Control: Same as 525A above.

Weight: Net 5 lbs. Shipping 8 lbs.

Price: $\text{\textcircled{C}}$ 525B, \$300.00.

$\text{\textcircled{C}}$ 525C Frequency Converter Unit

for Frequency Measurement, 100 MC to 510 MC. Plugged into $\text{\textcircled{C}}$ 524:

Range: As converter for counter, 100 MC to 510 MC. As amplifier for counter, 50 KC to 10.1 MC. Direct connection for 0 to 10.1 MC. Accuracy: Retains accuracy of 524 counter.

*See pages 120-122 for a discussion of counter accuracy considerations.

Registration: 9 places; first two places indicated on converter dial, next 7 displayed by counter.

Input voltage: 20 mv rms minimum, 50 KC to 10.1 MC; 100 mv rms minimum, 100 MC to 510 MC.

Input Impedance: Approximately 700 ohms, 50 KC to 10.1 MC. Approximately 50 ohms, 100 MC to 510 MC.

Level Control: Meter aids frequency selection; indicates relative voltage level.

Weight: Net 6 $\frac{1}{2}$ lbs., shipping 11 lbs.

Price: $\text{\textcircled{C}}$ 525C, \$475.00.

$\text{\textcircled{C}}$ 526A Video Amplifier Unit

for Frequency Measurement, 10 cps to 10.1 MC high sensitivity.

Plugged into $\text{\textcircled{C}}$ 524:

Range: 10 cps to 10.1 MC.

Accuracy: Retains accuracy of 524 Counter.

Input Voltage: 10 mv rms minimum.

Level Control: Meter indicates input signal level, correct voltage adjustment.

Output Terminal: Provides 10 times input voltage from 93-ohm source, for oscilloscope monitoring of input signal without loading circuit.

Reads In: Same as basic 524 Counter.

Weight: Net 5 lbs. Shipping 9 lbs.

Accessory Furnished: 1 $\text{\textcircled{C}}$ 10505A Probe.

Price: $\text{\textcircled{C}}$ 526A, \$200.00.

$\text{\textcircled{C}}$ 526B Time Interval Unit

for Time Interval Measurement. Plugged into $\text{\textcircled{C}}$ 524:

Range: 1 μ sec to 10⁴ seconds.

Accuracy: ± 1 /standard frequency counted, \pm time base accuracy. (See 524 General Specifications).

Input Voltage: 1 v peak minimum, direct-coupled input.

Input Impedance: Approx. 1 megohm, 40 pf shunt.

Start and Stop: Independent or common channels.

Trigger Slope: Positive or negative on start and/or stop channels.

Trigger Amplitude: Both channels continuously adjustable from -192 to +192 v.

Standard Frequency Counted: 10 cps, 1 or 100 KC; 10 MC or externally applied frequency.

Reads In: Sec, msec, or μ sec; decimal automatic.

Weight: Net 5 lbs. Shipping 9 lbs.

Accessory Furnished: 1 $\text{\textcircled{C}}$ 10503A Cable Assembly.

Price: $\text{\textcircled{C}}$ 526B, \$200.00.

$\text{\textcircled{C}}$ 526C Period Multiplier Unit

for Period Measurement. Plugged into $\text{\textcircled{C}}$ 524:

Range: 0 to 100 KC.

Gate Time: 1, 10, 100, 1,000, and 10,000 cycles of the unknown frequency.

Accuracy: ± 1 count $\pm 0.3\%$ /number of periods measured, \pm time base accuracy. (See 524 General Specifications.)

Standard Frequency Counted: 10 cps, 1 KC, 100 KC, 10 MC, or externally applied frequency.

Reads In: Seconds, milliseconds, or microseconds.

Input Voltage: 1 v rms minimum.

Input Impedance: 1 megohm, 40 pf shunt.

Weight: Net 5 lbs. Shipping 9 lbs.

Price: $\text{\textcircled{C}}$ 526C, \$225.00.

$\text{\textcircled{C}}$ 526D Phase Unit

for Phase Comparisons. Plugged into $\text{\textcircled{C}}$ 524:

Range: Phase angle, 0-360° lead or lag

Frequency Range: 1 cps to 20 KC.

Reads In: Seconds, milliseconds, microseconds; $\times 3600$ multiplier provides readings direct in tenths of degrees for signals 396-404 cps.

Accuracy: $\pm 0.1^\circ \pm \frac{F_p}{F_c} 360^\circ$, where F_p is frequency of phase-measured signal, F_c is counted frequency; assuming noise 65 db below signal and negligible counted frequency error.

Input Voltage: 5 to 120 volts rms.

Input Impedance: Approximately 1 megohm, 80 pf shunt.

Weight: Net 5 lbs. Shipping 9 lbs.

Price: $\text{\textcircled{C}}$ 526D, \$750.00.

Data subject to change without notice.

DY-5796 TRANSFER OSCILLATOR SYNCHRONIZER, 2590A MICROWAVE FREQUENCY CONVERTER

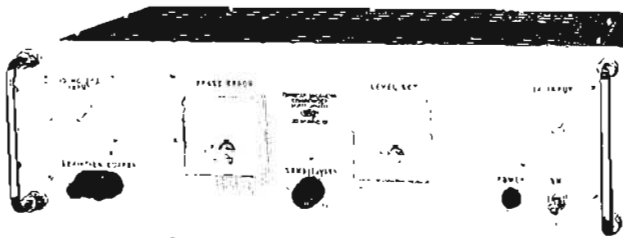

**NEW IN THIS
CATALOG**

**AVAILABLE
MID 1963**

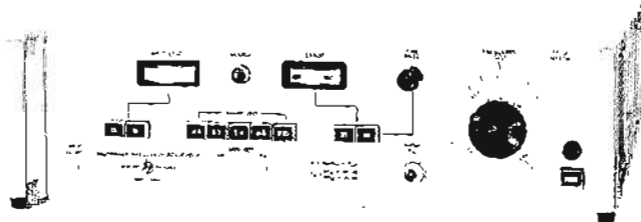

Through the use of phase locking techniques, precise frequency measurements of signals to 12.4 gc can be made by either of two instrument combinations. Both employ transfer oscillator/counter techniques with the oscillator frequency phase locked to the signal to be measured. Measuring accuracy is equal to the counter time base reference regardless of frequency or transfer oscillator drift.

The DY-5796 Transfer Oscillator Synchronizer phase-locks a Hewlett-Packard H06-540B Transfer Oscillator (pages 142, 143) to the unknown signal. The H06-540B frequency is conveniently measured by an *hp* 524C or D Electronic Counter with 525B or C Frequency Converter Plug-In (pages 138 through 140).

The *hp* 2590A Microwave Frequency Converter combines the functions of the transfer oscillator and transfer oscillator synchronizer in one compact instrument. Its use with an *hp* 5243L Counter and 5253A Frequency Converter (pages 128-130) allows frequency measurement to 12.4 gc with counter accuracy. The *hp* 2590A-5243L combination is also available with an *hp* 562AR Digital Recorder in a compact frequency measuring and recording system (DY-2040A).

By keeping the transfer oscillator and the signal frequency in permanent synchronization, the instruments also permit continuous measurements of frequency drift at microwave frequencies. FM deviation of the carrier frequency can be measured with the addition of a vtvm and/or oscilloscope. The instruments also simplify determination of the harmonic number and microwave frequency.

Measure Frequency to 12.4 GC,
with Counter Time Base Accuracy
and Stability

Specifications		
	DY-5796 when used with <i>hp</i> H06-504B and <i>hp</i> counter with converter	<i>hp</i> 2590A when used with <i>hp</i> counter and converter
Frequency Range:	200 mc to 12.4 gc	510 mc to 12.4 gc min.
Lock-on Range:	$\pm 0.2\%$ of signal frequency	$\pm 0.5\%$ of signal frequency
Sensitivity:	0 dbm min. signal input at 12.4 gc, decreasing to -30 dbm at 200 mc	0 dbm min. signal input at 12.4 gc, decreasing to -30 dbm at 510 mc.
Accuracy:	\pm stability* \pm resolution	\pm stability** \pm resolution
Registration:	9 places, first 2 on converter dial, next 7 on counter	9 places, first 2 on converter dial, next 7 on counter
FM Measurements:	Follows deviations up to 0.2% of signal frequency at rates to 1 kc; above 1 kc max. deviation limit reduced at 20 db/decade to max. of 0.001% at 200 kc	Deviation range, ± 1 mc; linearity, $\pm 1\%$ to 0.25 mc, $\pm 5\%$ to 1 mc; frequency response, 0 to 1 mc ± 3 db; output level, 10 v/mc
Power:	115 or 230 v $\pm 10\%$, 50 to 1000 cps, 35 watts	115 or 230 v $\pm 10\%$, 50 to 1000 cps, approx. 35 watts
Dimensions:	19" wide, 5 $\frac{1}{4}$ " high, 9 $\frac{1}{2}$ " deep behind panel	16 $\frac{3}{4}$ " wide, 5 $\frac{1}{2}$ " high, 18 $\frac{3}{8}$ " deep. Hardware furnished converts units to 19" x 5 $\frac{1}{4}$ " rack mount, 16 $\frac{3}{8}$ " deep behind panel
Weight:	Net, 14 lbs. Shipping 22 lbs.	Net 14 lbs. Shipping 22 lbs.
Price:	DY-5796: \$685	Information available on request
<p>*Stability: 3/10⁸ short term, 5/10⁸ per week, improves to 5/10¹⁰ per day when used with <i>hp</i> 103AR Quartz Oscillator. Resolution: ± 1 count at transfer oscillator frequency.</p> <p>**Stability: Same as <i>hp</i> 5243L Electronic Counter time base (See page 128). Resolution: ± 1 count at transfer oscillator frequency.</p>		

Data subject to change without notice.

540B TRANSFER OSCILLATOR



Measure Frequency to 18 GC with Electronic Counter Accuracy

Advantages:



- Extends frequency counter accuracy to microwave region
- Measures to 18 GC with new fixed tuned mixers and to 40 GC with external mixers and microwave amplifiers
- Permits measurement of pulsed, FM, CW, AM or noisy signals
- Provides multiple check for positive accuracy
- Measures FM deviation
- Includes self-contained oscilloscope
- Circuit elements usable separately
- Simple to use, compact, eliminates complex set-ups

Uses:

- Fast, accurate determination of CW and AM signal frequencies
- Measuring center frequency or deviation range of FM signals
- Measuring frequency in presence of high noise levels
- High accuracy measurements of pulsed signals

Use of  540B Transfer Oscillator with  counters, frequency converters and fixed tuned mixers permits measurements far into the microwave region with accuracy and simplicity otherwise available only at much lower frequencies.

Model 540B contains a highly stable 100 to 220 MC oscillator generating harmonics to at least 12.4 GC for comparison. Comparison is made by means of a broadband, untuned, diode mixer system, amplifier and oscilloscope, all within the instrument. In addition, the built-in harmonic generator provides signals for driving external amplifiers and mixers for measurements above 12.4 GC.*

Combined with an  524 Counter with  525B or 525C Frequency Converter Plug-in, or the solid-state 5243L or 5245L with 5253A Frequency Converter Plug-in, the 540B extends the counter's range to 12.4 GC. With the new  P932A Harmonic Mixer, simple, accurate measurement is available to 18 GC.

In operation, with approximate signal frequency known, the  540B is tuned until one of its harmonics beats with the unknown. The multiplying factor is noted. The transfer oscillator frequency is then measured directly on the 524 Counter. The counter's frequency reading, times the multiplying factor, gives the frequency of the unknown signal. When the signal frequency is totally unknown, a convenient calculation employing two or more harmonics is used to determine the multiplying factor.

In measuring carrier frequency of pulsed signals, an exter-

*The use of external traveling wave amplifiers and waveguide mixers for measurements in P, K and R bands (12.4 to 40 GC) is described in Application Notes No. 2 and No. 21 available on request.

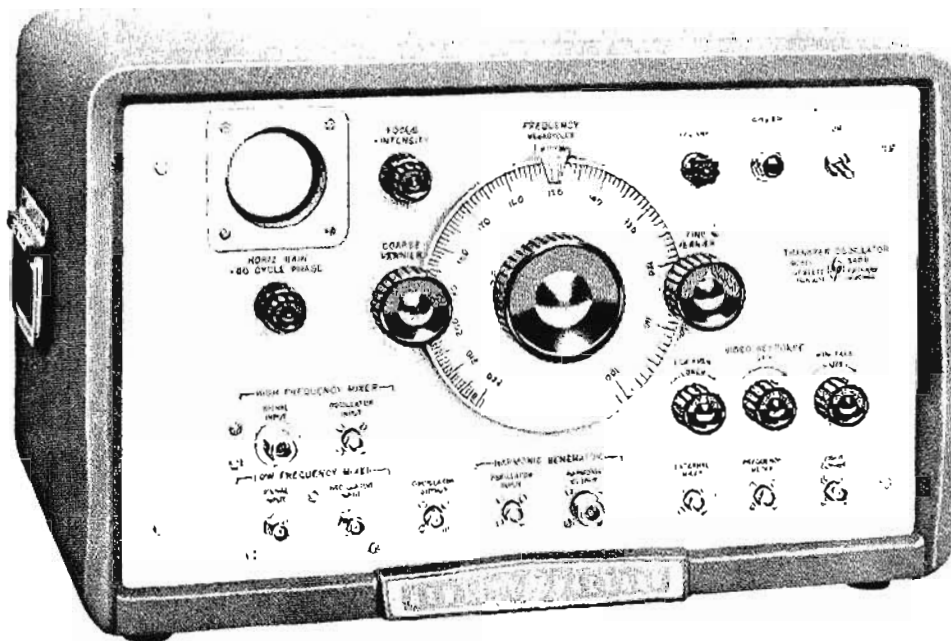

nal oscilloscope is used to display the detected pulse. Zero beat appears as horizontal lines across the pulses when the oscillator is tuned to an exact sub-multiple. Video amplifier frequency response controls can be used to simplify this procedure.

In working with noisy or AM signals, the Ⓢ 540B response can be narrowed to obtain a more accurate indication of zero beat.

In signals with appreciable FM, the 540B's oscilloscope presents a characteristic pattern pin-pointing upper and lower frequency deviation limits. If FM deviation is present, center frequency may also be determined.

P-Band Measurements

The Ⓢ P932A Harmonic Mixer mounts directly in the waveguide system and operates with either the 540A or 540B, mixing generated harmonics with the unknown waveguide frequency. The mixer's beat frequency output is applied to the 540. The measuring procedure is the same as the procedure using the 540's internal mixer.

An earlier Ⓢ Transfer Oscillator, Model 540A is widely used for making measurements to 5 GC. The Ⓢ 934A Harmonic Mixer operates from 2 to 12.4 GC, and extends the range of the 540A from 5 GC to 12.4 GC. Both the 934A and P932A are fixed tuned.

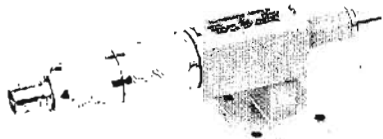

Ⓢ P932A Harmonic Mixer.

Accuracy

The system's accuracy approaches that of the electronic counter on clean CW signals. On pulsed signals, accuracy is governed by carrier frequency and pulse length. On noisy or intense AM signals, the transfer oscillator system with Ⓢ 540B often provides the only means of accurate measurement. Overall system accuracy is greater than 10 times that of the best microwave wavemeters.

A direct-coupled reactance control circuit in the Ⓢ 540B allows the oscillator to be locked at a sub-multiple of the measured frequency when it is desirable to measure automatically or record drift characteristics of microwave signal sources.

Quality Features

Each of the circuit elements of Ⓢ 540B may be used separately by shifting front panel patch cords. Controls are provided for coarse and fine mechanical tuning. There also is an electrical vernier with range approximately ± 125 parts per million. The video amplifier has both gain and bandwidth controls. Horizontal input to the internal oscilloscope is power line frequency with phase control, or external signals from 20 cps to 5 KC.

Specifications, Model 540B

General

Frequency Range: 10 MC to 12,400 MC.
Input Signal: CW, FM, AM or pulse.
Input Signal Level: Varies with frequency and individual crystals. (See chart.)
Accuracy: CW: Approximately 1/10,000,000 or better.

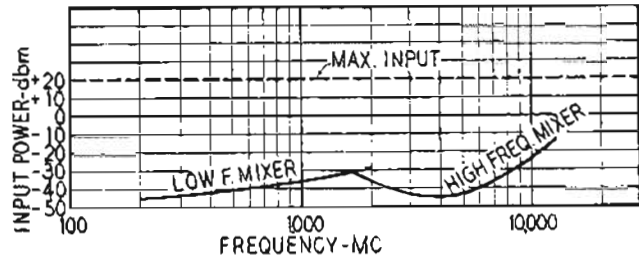

Typical Sensitivity, Model Ⓢ 540B.

Oscillator

Fundamental Frequency Range: 100 MC to 220 MC.
Harmonic Frequency Range: Above 12.4 GC.
Stability: Less than 0.002% change per minute after 30-minute warmup.
Dial: Six inch diameter, calibrated in 1 MC increments.
Accuracy: $\pm 0.5\%$.
Output: Approximately 2 v into 50 ohms.

Amplifier

Gain: Adjustable, 40 db max.
Bandwidth: Variable. High Frequency: 3 db point adjustable approximately 1 KC to 2 MC. Low Frequency: 3 db point switched from 100 cycles to below 10 KC, then continuously adjustable to above 400 KC.
Output: 1 v rms maximum into 1,000 ohms.

Oscilloscope (Self-Contained)

Frequency Range: 100 cps to 200 KC.
Vertical Deflection Sensitivity: 5 mv rms per inch.
Horizontal Sweep: Internal, power supply frequency with phase control, or external (connection at rear) with 1 v per inch, 20 cps to 5 KC.

Miscellaneous

Size: Cabinet Mount: 20 $\frac{3}{4}$ " wide, 12 $\frac{1}{2}$ " high, 15 $\frac{1}{4}$ " deep. Rack Mount: 19" wide, 10 $\frac{1}{2}$ " high, 14 $\frac{1}{4}$ " deep behind panel.
Weight: Net 42 lbs. Shipping 53 lbs. (cabinet). Net 35 lbs. Shipping 50 lbs. (rack mount).

Power Supply: 115 or 230 v $\pm 10\%$, 50 to 1,000 cps, approximately 110 w.

Accessories Furnished: Ⓢ 10503A Cable Assembly, 4' long, BNC to BNC. A 6" jumper cable (BNC to BNC) is also included for use between jacks on front panel.

Auxiliary Equipment:

Ⓢ 524 10 MC Electronic Counter, (pages 138-140).
 Ⓢ 525B Frequency Converter, 100-220 MC, (page 140). Ⓢ 525C Frequency Converter Unit, 100-510 MC, (page 140.) Ⓢ 130C Oscilloscope, (pages 30, 31). Ⓢ 5243L 20 MC Electronic Counter (page 128). Ⓢ 5245L 50 MC Electronic Counter, (page 128). Ⓢ 5253A Frequency Converter, 100 to 500 MC, (page 129).

Price: Ⓢ 540B, \$900.00 (cabinet); Ⓢ 540BR, \$885.00 (rack mount). Ⓢ 540B mixer [2 to 12.4 GC] available for use with Ⓢ 540A; specify Model 934A, \$150.00; Ⓢ P932A Mixer (12.4 to 18 GC) for use with 540A and 540B, \$250.00.

Available from Dymec:

Transfer Oscillator (H06-540BR, rack, \$950.00; H06-540B, cabinet, \$965.00) with increased frequency control sensitivity for use with DY 5796 Transfer Oscillator Synchronizer (see page 141).

Data subject to change without notice.

560A, 561B DIGITAL RECORDERS

Print 11-Digit Information at Rates of 5 Lines Per Second

Advantages:

Controllable by electronic or electro-mechanical devices
11-digit parallel entry; primary and supplementary data can be recorded simultaneously

High speed printing rate; use folded or standard roll paper, standard typewriter ribbon
Analog output for strip-chart or X-Y recorder (560A only)

Uses:

Record displays of frequency counters, 405CR Digital Voltmeter
Record time functions
Digital to analog converter for strip-chart recording (560A only)
Make permanent telemetering records
Monitoring, final tabulation and plotting of tests
Investigating drifts in systems and equipment

The *hp* 560A, 561B Digital Recorders are useful for recording from *hp* electronic counters and digital voltmeters. Both models have a printing speed of five 11-digit lines per second, the 11-digit line allowing secondary or coding data to be entered simultaneously with the primary data. Recorder data accuracy is the same as the accuracy of the data gathering input.

Operation—Model 560A

In the *hp* 560A the position of each print wheel is determined by the output voltage from its corresponding decade in an *hp* counter or *hp* 405CR Digital Voltmeter. A signal from the printer supplied to the counter or voltmeter prevents the decade from taking another sample until the print cycle is completed. All wheels are positioned simultaneously during each recorder scan period, a print of the data is made, and the paper automatically advances to display the printed count.

The 560A produces analog output signals for driving potentiometer or galvanometer strip-chart or X-Y recorders.

The outputs consist of current or voltage, proportional to the value of any three-digit number printed, which permits plotting data variations such as oscillator drift where the important information is in the last few digits of the printed record. Analog records of extreme accuracy and resolution result. Automatic zero suppression keeps the recorder always on-scale and indicates range changes in the plotted data.

Specifications—Model 560A,AR

Accuracy: Identical to that of basic counter used.

Printing Rate: 5 lines/sec. maximum.

Column Capacity: To 11 columns (12 on special order).

Print Wheels: 12 position, having numerals 0 through 9, a minus, and a blank. Other symbols available.

Data Entry: One wire for each print wheel.

Driving Source: Hewlett-Packard and Dymec electronic counters with recorder kits installed. *hp* 405CR DC Digital Voltmeter with *hp* 405A-95C Adapter, or other sources providing appropriate "staircase" input voltages.

Print Command Signal: ± 15 volts peak, 10 μ sec or greater in width, 1 volt/ μ sec minimum slope. Manual control with momentary-contact switch.

Paper Required: Standard 3" roll, or *hp* 560A-131A folded paper.

Line Spacing: Zero, single or double, adjustable.

Analog Output, 3 Digit: 1000 step staircase directly proportional to count indicated by any three (or the right-hand two) adjacent columns selected by analog output selector switch. (Example: if consecutive digits were 3, 8, and 6; output voltage would be 38.6 millivolts; and 99.9 millivolts if consecutive digits were 999.)

Output Available: 0 to 1 ma for galvanometer strip-chart recorders, 0 to 100 mv for potentiometer strip-chart recorders.

Power Requirement: 115 or 230 v $\pm 10\%$, 50 to 60 cps, 250 watts; 4 prints/sec maximum on 50-cycle lines.

Dimensions: Cabinet: 20 $\frac{3}{4}$ " wide, 12 $\frac{3}{4}$ " high, 18 $\frac{1}{2}$ " deep.
Rack: 19" wide, 10 $\frac{1}{2}$ " high, 20 $\frac{1}{2}$ " required rack depth.

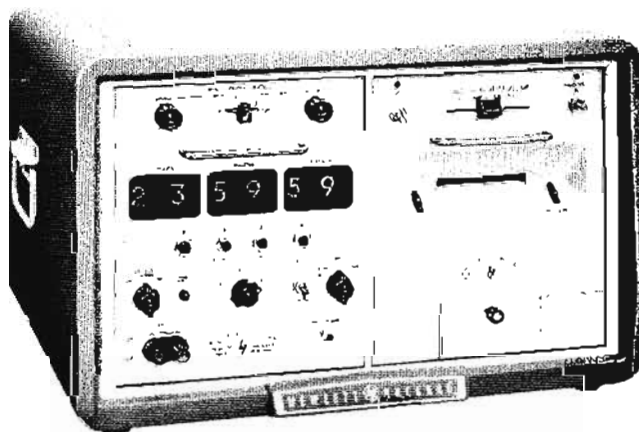

Weight: Net 63 lbs. Shipping 79 lbs. (cabinet mount).
Net 55 lbs. Shipping 79 lbs. (rack mount).

Accessories Furnished: 1 560A-16H Input Cable (accommodates 8 columns); 560A-95N Service Kit; 1 packet 9281-0018 folded paper tape; 1 9283-0002 inked ribbon.

Accessories Available: Digital recorder kits for field installation in:

hp Model	Kit Number	Price
521-Series	521D-95A	\$45
522B	522B-95A	\$45
523B	523B-95A	\$45
523C,D	523D-95A	\$45
524B	524B-95C	\$175
524C,D	524D-95A	\$75

405-95C Adapter, connects 560A to 405CR Digital Voltmeter, \$70. 560A-16H Cable, \$60. 560A-16P Extension Cable, 6', 20-conductor, \$65. 560A-16Q Extension, 6' 26-conductor, \$85. 560A-131A folded Paper Tape, 24-packet carton, \$20. No. 9283-0002 inked ribbon, \$3.50. Additional comparators are available to increase print-out of basic 560A from 6 columns to a maximum of 11 columns. These comparators plug into sockets in the 560A. 560A-58 Plug-in Comparator Unit, \$25 each. **Price:** hp 560A, \$1400 (cabinet); hp 560AR, \$1385 (rack mount). Includes 6 plug-in comparators. Also available for 50-cycle power line operation retaining 5 prints/sec maximum, and/or 570A Digital Clock installed and/or 12-column operation, prices on request.

Operation—Model 561 B

Model 561B Digital Recorder differs from the 560A in that input is a 10-line coded decimal entry; that is, one connection is made for each position of each print wheel. The 561B is normally operated from an hp 405CR Digital Voltmeter or by in-line readout frequency counters with 10-line output kits installed. The 561B also can be operated from relays, stepping switches and beam switching tubes.

When a print command is received by the 561B, the clutch engages, turning the print wheels. Each print wheel turns until its armature contacts a voltage which shuts off current to the pawl magnet, thus stopping the print wheel in the appropriate position. To prevent changes in input informa-

tion during the recorder scan cycle, the 561B supplies an inhibit signal to hp counters while the print wheels are being positioned. This same inhibit signal may be used to prevent data changes during the recorder scan cycle with instruments other than hp counters and digital voltmeters.

Specifications—Model 561B, BR

Same as 560A except:

Column Capacity: 11 columns (12 on special order).

Input: Decimal code, 10 lines plus 2 lines for blank and minus sign from each column.

Driving Source: Hewlett-Packard in-line readout counters having 561B recorder kits installed. (See counter specifications.) hp Digital Voltmeter. (See voltmeter specifications.) Stepping switches, relays, beam switching tubes, contact closure, or - 15 to - 100 volts connected to appropriate number wire. Operates from 10-line coded systems.

Print Command: ± 15 volts peak or more, 10 μ sec minimum width, 1 volt/ μ sec minimum slope, or external closure. Manually controlled by a momentary contact toggle switch. Print commands during scan and print action have no effect.

Power: 115 or 230 v $\pm 10\%$, 50 to 60 cps, approximately 75 watts. 4 prints/sec maximum on 50-cycle lines.

Weight: Net 35 lbs., shipping 70 lbs. (cabinet). Net 30 lbs., shipping 65 lbs. (rack mount).

Accessories Furnished: 1 561B-16A Input Cable (accommodates 6 columns); 1 packet 9281-0018 folded paper tape; 1 9283-0002 inked ribbon; 560A-95N Service Kit.

Accessories Available: Digital recorder kits for field installation: 521D-95B, \$45, for 521D and 521E Counters; 523C-95B, \$45, for 523C; 524C-95B, \$150, for 524C. 560A-131A Folded Paper Tape, 24 packets, \$20; No. 9283-0002 Inked Ribbon, \$3.50; 561B-16A Cable, \$100; 561B-95D Connector, \$8.50.

Price: hp 561B, \$1150 (cabinet); hp 561BR, \$1135 (rack mount). Also available for 50-cycle operation retaining 5 prints/sec, and/or with 571B Digital Clock installed, and/or 12-column operation. Prices on request.

Data subject to change without notice.

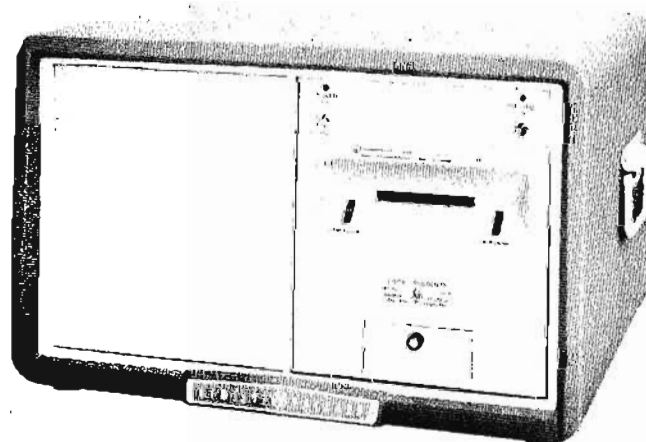

562A DIGITAL RECORDER

Flexible Data Input with Information Storage

Hewlett-Packard Model 562A Digital Recorder is a transistorized electro-mechanical device providing a printed record of digital data from any of a number of sources. Parallel data entry and low-inertia moving parts allow printing rates as high as 5 lines per second, each line containing up to 11 digits. 12-digit capacity is available on special order. Model 562A uses the same fast mechanical system pioneered by *hp* in Models 560A and 561B Digital Recorders.

Data Storage

A unique data storage feature allows the driving source to transfer its data to the 562A in 2 milliseconds. As soon as this data transfer is completed, the driving source is released to gather more information. Reducing the time that the driving source must hold a reading makes possible a higher rate of data collection. Model 562A is extremely flexible, and can be used in a wide variety of individual and system applications.

Data Entry

Data enters the unit through rear-mounted 50-pin connectors. Internal plug-in connectors route the information to any desired sequence of print wheels. A separate storage binary unit is associated with each individual print wheel for 4-line BCD input codes. On print command each storage binary unit assumes the condition of the decade counting unit (or other driving source) connected to it. This data transfer takes place in 2 milliseconds, after which time the driving source is free to accumulate additional information.

The storage binary unit for each column is mounted on a plug-in card with a resistor matrix, which translates the stored data into positioning information for the print wheels. Model 562A may be equipped to translate 1-2-2-4 BCD or other 4-line codes by simply substituting plug-in cards. 10-line code operation is also available by card substitution and the

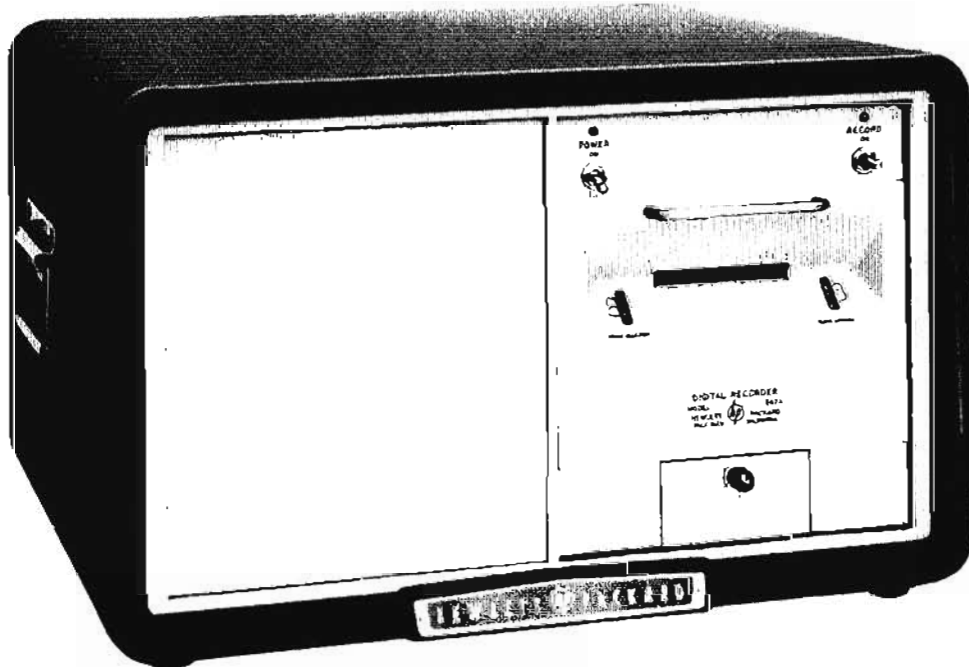

© 562A

mounting of additional input plugs; however, information storage is not available for 10-line data.

Flexible Options

Since each print wheel operates with its own plug-in card, different input codes may be used for separate wheels. Also, the capacity for dual input coupling is an inherent feature of the 562A which permits data from two unsynchronized sources to be printed simultaneously.

In addition to the standard print wheels which have numerals "0" through "9," a minus sign and a blank, a wide variety of special character wheels may now be obtained from stock.¹

Analog Output

An analog output, suitable for driving potentiometer or galvanometer recorders, is available as an option for 562 models which have 1-2-2-4 or 1-2-4-8 BCD column boards installed. A switching arrangement utilizes the stored binary data from three consecutive columns of the printed data. Any three of the first nine columns may be used for a 1000-step analog, or the two righthand digits may be used for a 100-step analog. The analog function is available to drive potentiometer or galvanometer strip-chart recorders without having the print mechanism in operation. Signals from the three columns are weighted in a 100:10:1 ratio and summed so that the analog output signal is a 1000-step staircase as the numerals printed change from 000 to 999. Controls are provided for recorder calibration and zero adjustment.

Specifications

Accuracy: Identical to input device used.
Printing Rate: 5 lines per second, maximum.
Column Capacity: To 11 columns (12 available on special order).
Print Wheels: 12 positions, numerals 0 through 9, a minus sign, and a blank. Other symbols available.¹
Input Requirements:
Data Input: Parallel entry, BCD (1-2-2-4, 1-2-4-8, or 1-2-4-2) or 10-line, see Options. "1" state must differ from "0" state by at least 4 v but by no more than 75 v.
Reference Voltages: BCD codes require both "0" and "1" state references. 10-line codes require reference voltage for "0" state. Reference voltages may not exceed ± 150 v to chassis.² Input impedance is approximately 270K.
Hold-off Signals: Both polarities are available simultaneously for BCD codes and are diode coupled; 10 ma maximum load, + 15 v open circuit from 1K source, - 5 v open circuit from 2.2K source. 160 ms hold-off is provided for 10-line codes.
Print Command: + or - pulse, 6 to 20 volts amplitude, 1 v/ μ sec minimum rise time, 20 μ s or greater in width, ac coupled.
Analog Output (Optional): (From 1-2-2-4 or 1-2-4-8 boards.) Accuracy is $\pm 0.5\%$ of full scale or better. 100 mv for potentiometer recorder; 50K minimum load resistance. 1 ma into 1.5K maximum for galvanometer recorder.
Transfer Time: 2 ms for BCD input.
Paper Required: hp folded paper tape (15,000 prints per packet with single spacing), or standard 3-inch roll tape.
Line Spacing: Zero, single or double. In "zero", does not print, paper does not advance.
Power Requirements: 115 or 230 v $\pm 10\%$, 50 to 60 cps, approximately 130 watts. (4 prints per sec. maximum at 50 cps; 50 cps model with 5 prints per second available.)
Dimensions: 20 $\frac{3}{4}$ " wide, 12 $\frac{1}{2}$ " high, 18 $\frac{1}{2}$ " deep (cabinet); 19" wide, 10 $\frac{1}{2}$ " high, 20" deep behind panel, with connector allowance (rack mount).
Weight: Cabinet: Net 35 lbs. Shipping 80 lbs. Rack Mount: Net 30 lbs. Shipping 63 lbs.
Accessories Furnished: One packet folded paper tape. 560A-95N Service Kit: Contains machine oil, moly oil, moly grease and type cleaner.

Accessories Available: 560A-131A folded paper tape, 24-packet carton, \$20. 560A-131B, paper for diazo copies, 24-packet carton, \$35. No. 9283-0002 Inked Ribbon, \$3.50. Also available, H03-571B Digital Clock, price on request.

Price: Basic unit with 11-column capacity. Column boards, input connector assemblies, and cables required for operation are not included, see Options. hp 562A (cabinet, base unit), \$1085; hp 562AR (rack mount, base unit), \$1060.

Options: Group 1. Equipped for operation with hp and Dymec instruments. These options include the required Column Boards, Input Connector Assemblies, and Input Cables.

Option 11. Equips 562A for 6-column operation from 1-2-2-4. "1" state positive code, add \$340.

Option 12. Equips 562A for 9-column operation from 1-2-2-4. "1" state positive code, add \$765.

Option 13. Equips 562A for 11-column operation from 1-2-2-4. "1" state positive code, add \$993.

Option 14. Equips 562A for operation with 5243L or 5245L. 10-column operation; prints measurement unit and indicates decimal position, e.g., 16942.496 kc would be printed as 3KC16942496. The first digit shows how far to move the decimal to the left, add \$865.

Group 2. Column Boards.

Option 21. 1-2-2-4 "1" state positive, \$75 per board.

Option 22. 1-2-4-8 "1" state positive, \$75 per board.

Option 23. 1-2-4-8 "1" state negative, \$75 per board.

Option 24. 1-2-2-4 "1" state negative, \$75 per board.

Option 25. 10-line "1" state positive (no storage), \$50 per board.

Option 26. 10-line "1" state negative (no storage), \$50 per board.

Option 27. 1-2-4-2 "1" state negative, \$75 per board.

NOTE: Input Connector Assemblies and Input Cables (Group 3 Options) are required for use with Group 2 Column Boards.

Group 3. Connector Assemblies.

Option 30. BCD Input Connector Assembly for up to nine columns, \$55.

Option 31. BCD Input Connector Assembly for up to six columns, \$43.

Option 32. Input Cable, for up to nine BCD columns or three 10-line columns, \$35 ea.

Option 33. 10-line Input Connector Assembly for up to three columns, \$35 ea.

NOTE: More than one Input Connector Assembly and Input Cable are required for: (1) More than nine BCD columns; (2) Operation from two sources; (3) More than three 10-line columns.

Group 4. Analog Output.

Option 41. Analog Output (from 1-2-2-4 boards), \$175.

Option 42. Analog Output (from 1-2-4-8 boards), \$175.

Typical Orders: One hp Model 562AR Digital Recorder to print six columns from an hp counter which provides a BCD (1-2-2-4 "1" state positive) output and with analog output.

hp 562AR	\$1060
Option 11.	540
Option 41.	175
	<hr/>
Total	\$1775

One hp Model 562A Digital Recorder to print columns 1 through 8 from an hp counter which provides a BCD (1-2-2-4 "1" state positive) output and columns 9 through 11 from a 10-line "1" state positive source which holds its data for at least 160 ms after the print command.

hp 562A	\$1085
8 Option 21.	600
3 Option 25.	150
Option 30.	55
Option 33.	35
2 Option 32.	70
	<hr/>
Total	\$1995

One hp Model 562AR Digital Recorder to operate with hp Model 5243L Electronic Counter and to have an analog output.

hp 562AR	\$1060
Option 14.	865
Option 41.	175
	<hr/>
Total	\$2100

¹See hp Application Note 32 for information on special print wheels.
²Reference voltage requirements in the range of -9 to + 16 volts may be obtained from a resistive voltage divider added to the 562A power supply module. Deriving the reference voltages from the driving source is highly recommended, however, so that recorder reference voltages will follow changes in the "0" and "1" references of the driving source.

Data subject to change without notice.

hp 565A DIGITAL PRINTER, hp 570A, 571B DIGITAL CLOCKS

Printer for Custom Use, Clocks for Time Factor Recording or Control

hp 565A Digital Printer

Mechanically similar to printing mechanisms in *hp* 560, 561, 562 Digital Recorders, the *hp* 565A Printer is a fast 11-column unit designed specifically for use in custom systems. It is useful as an output device in computer and data handling systems involving electronic counters, mechanical counters with electrical output, stepping switches, relays, beam switching tubes and other digital devices.

Specifications

Number of Columns: 11 (12 available on special order).
Data Entry: Parallel entry to all columns. One line required for each position of each print wheel to be operated.
Maximum Print Rate: 5 lines per second.
Standard Characters (others available on special order): 0 through 9, minus sign (-), blank. Dimensions: approximately 0.085" wide, 0.100" high. Column spacing: 1/4". Line spacing: 5/32" single space; 5/16" double space.
Power: Motor: 115 v \pm 10%, 60 watts, 50 to 60 cps (50 cps provides 4 prints/sec maximum). Clutch solenoid: 240 to 260 v dc, 75 ma (operates for approximately 15 ms to start printing cycle). Coil designed for vacuum tube switching networks. Lower voltage coils are recommended and available on special order for transistor switching. Pawl magnets: 60 to 70 v dc, 15 ma (operate when needed during printing cycle). Coils designed for vacuum tube switching networks. Lower voltage coils are recommended and available on special order for transistor switching.*
Weight: Net 15 lbs. Shipping 28 lbs.
Dimensions: Front panel: 9 3/4" high, 8 3/8" wide, 9 3/4" deep behind panel.
Price: Model 565A Digital Printer (with high voltage clutch and pawl coils for vacuum tube drive), \$750 (quantity discount available). For 115 v, 50 cps operation with 5 prints/sec capability specify H27-565A, \$763 (quantity discount available). For 230 v, 50 cps operation with 5 prints/sec capability specify H24-565A, \$765 (quantity discount available).

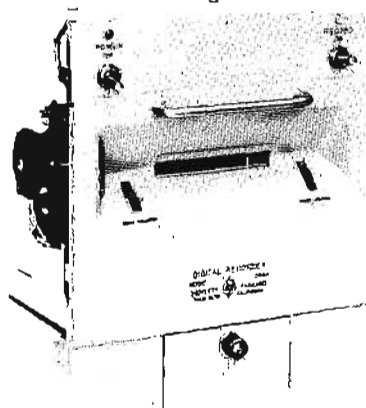

hp 565A

hp 570A, 571B Digital Clocks

The 570A, 571B Digital Clocks, which mount in the left side of the *hp* 560A and 561B Digital Recorders, provide time-of-day information and control the rates at which measurements are made. They indicate time in hours, minutes, and seconds (24 hour basis) in an in-line display. All time digits displayed are available for printing. Clocks may be ordered installed in the respective recorders. In addition, a modified 571B, H03-571B, is available for use with the *hp* 562A Digital Recorder.

Specifications

Indication: Six in-line digital display tubes indicate to 23 hours, 59 min., 59 sec. Twelve-hour format available on special order.
Time Base: Front panel Time base switch selects: (1) 60 cps (50 cps available on special order); (2) Counter (1 pps from *hp* counters); (3) External (5 v positive pulses, 200 μ sec long, 1 pps. Input impedance approximately 500 ohms).
Time Print Format: 570A: Program plug at rear of 560A serves all 11 columns of digital recorder. Time format determined by wiring of program plug. Normally wired to print six time digits on left side of 560A paper. Blank can also be programmed in any single column by program plug. 571B: Six time digits may be recorded in right-hand six columns of 561B with clock cable connected to J101 on 561B. With clock cable connected to J102, time digits will be recorded in the five left-hand columns of the 561B, without the tens-of-hours digit.
Weight: Net 20 lbs. Shipping 28 lbs.
Power: AC and dc supplied by digital recorder, approximately 15 watts. (Normally wired to operate on 60 cps line, but 50 cps version is available.)
Price: *hp* 570A, \$1050; *hp* 571B, \$1000.

*Consult your *hp* representative and Application Note #32 for more information concerning transistor drivers for the 565A.

Because of the many option arrangements for the *hp* 565A, 570A, and 571B, please contact your nearest sales representative for assistance when ordering or requesting quotations.

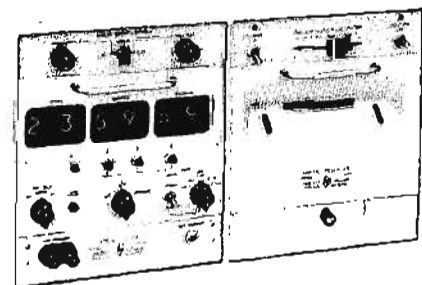

hp 570A in 560AR Digital Recorder

580A, 581A DIGITAL-TO-ANALOG CONVERTERS

Automatic Zero Shift, High Resolution with Conventional Strip-Chart Recorders

These digital-to-analog converters accept 4-line BCD output from electronic counters, digital voltmeters and other devices and provide output for making accurate, automatic records on conventional strip chart and X-Y recorders.

The 580A and 581A operate directly from Hewlett-Packard solid state counters. In addition, the vacuum tube counters in both the *hp* and Dymec lines can be modified to provide the BCD output to drive these converters. Because they accept a wide range of input voltages, they are also usable with other vacuum tube and solid state devices, including nuclear scalars. Output signals for both potentiometer and galvanometer type recorders are available, and controls are provided for recorder calibration and zero adjustment.

A 50-pin connector accepts up to nine digits of 4-line data from the driving source. Any three successive digits (or the right-hand two) may be chosen for analog output, and selection of the least significant digits permits high resolution. Automatic zero shifting is inherent in the output, so that the record is "on scale" at all times. The instrument stores, translates and weights the data to provide the proper analog output voltage or current.

Specifications

Accuracy: 0.5% of full scale or better.

Potentiometer Output: 100 mv full scale; minimum load resistance 20K; calibrate control; dual banana plugs front and rear.

Galvanometer Output: 1 ma full scale into 1500 ohms; zero and calibrate controls; phone jack front and rear.

Driving Source: Parallel entry 4-line BCD, 1-2-2-4 (9 digits maximum). "1" state \pm 4 to \pm 75 volts with reference to "0" state.

Reference Voltages: Reference voltages required for both the "0" and "1" state. Reference voltages not to exceed \pm 150 volts to chassis.

Command Pulse: Positive or negative pulse, 20 μ sec or greater in width, 6 to 20 volts amplitude.

Transfer Time: 1 millisecond.

Power Requirements: 115 or 230 volts \pm 10%, 50 to 1000 cps, 11 watts.

Dimensions: 580A: 16 $\frac{3}{4}$ " wide, 3 $\frac{7}{8}$ " high, 11 $\frac{1}{2}$ " deep. Hardware furnished converts cabinet to 19" by 3 $\frac{1}{2}$ " rack mount. 581A: 7-25/32" wide, 6 $\frac{1}{2}$ " high, 9" deep.

Weight: 580A: Net 13 lbs., shipping 16 lbs. 581A: Net 8 lbs., shipping 13 lbs.

Accessory Furnished: 562A-16C Cable, 6' long with an Amphenol 57-30500 connector at each end.

Price: *hp* 580A, \$525. *hp* 581A, \$525.

Data subject to change without notice.

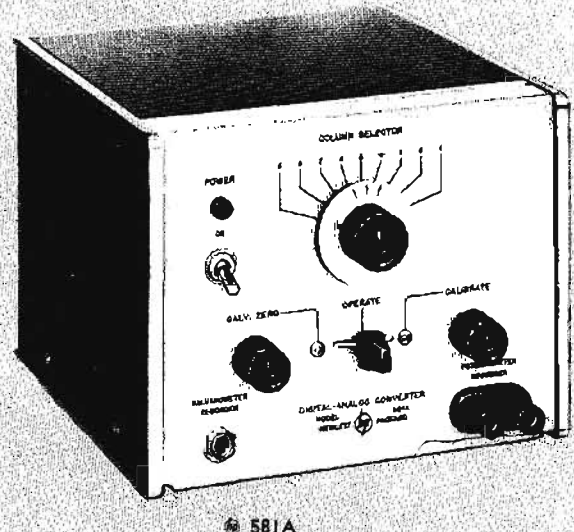
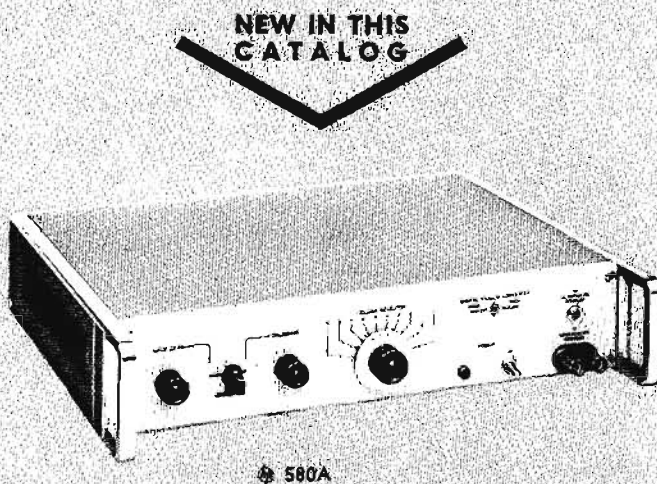

hp 500B,C ELECTRONIC FREQUENCY METERS

Measure Frequency of AC Voltages as High as 100 KC

The hp Model 500B directly measures the frequency of an alternating voltage from 3 cps to 100 kc. Suitable for laboratory and production measurements of audio and ultrasonic frequencies, it is also useful for direct tachometry measurements with a transducer such as hp 506A or 508A,B,C,D. Use of the 508A (which produces 60 pulses per revolution) converts the scale calibration of the 500B from cps to rpm. For still greater convenience in tachometry work, the meter is available as hp 500C with scale calibration in rpm.

Readings on the 500B and 500C are not affected by variations of input signal level or power line voltage. The meter will count sine waves, square waves or pulses and will indicate the average frequency of random events. Provision is made for checking the calibration against power line frequency and to operate a recorder for a continuous frequency record or X-Y plot.

Expanded Scale Feature

Any 10% or 30% portion of a selected range on the 500B and 500C may be expanded to full meter scale. This means that for repetitive or differential type measurements the meter can be set for expanded scale readings and left in this position to observe small fluctuations in readings. The expanded scale permits accurate measurement of small frequency changes.

Pulse Output

A pulse output, synchronous with each input pulse, is available on the front panel. This output provides uniform pulses which can be used to measure the FM component of the input signal or to sync a stroboscope or an oscilloscope. The output pulse could be used, for example, in conjunction with a stroboscope for observation of the various parts of a gear train when checking for the presence of vibration or torsion.

Specifications 500B

Frequency Range: 3 cps to 100 kc, 9 ranges in 10, 30, 100 sequence.

Expanded Scale: Allows any 10% or 30% portion of a selected range to be expanded to full meter scale (except 10 cps range).

Input Voltage: Sensitivity: 0.2 v rms minimum for sine waves, + 1.0 v peak minimum for pulses. Maximum: 250 v peak. Sensitivity control reduces threshold sensitivity.

Input Impedance: Approx. 1 megohm shunted by 40 pf. BNC connector for input.

Accuracy: Better than $\pm 2\%$ of full scale (unexpanded). Reading affected less than 0.5% by $\pm 10\%$ variation from nominal line voltage. Expanded x3 scale (differential measurements of 30% or less), better than $\pm 1.5\%$ of range switch setting. Line voltage variations of $\pm 10\%$ affect reading less than $\pm 0.5\%$. Expanded x10 scale (differential measurements of 10% or less), better than $\pm 0.75\%$ of range switch setting. Line voltage variations of $\pm 10\%$ affect reading less than $\pm 0.25\%$.

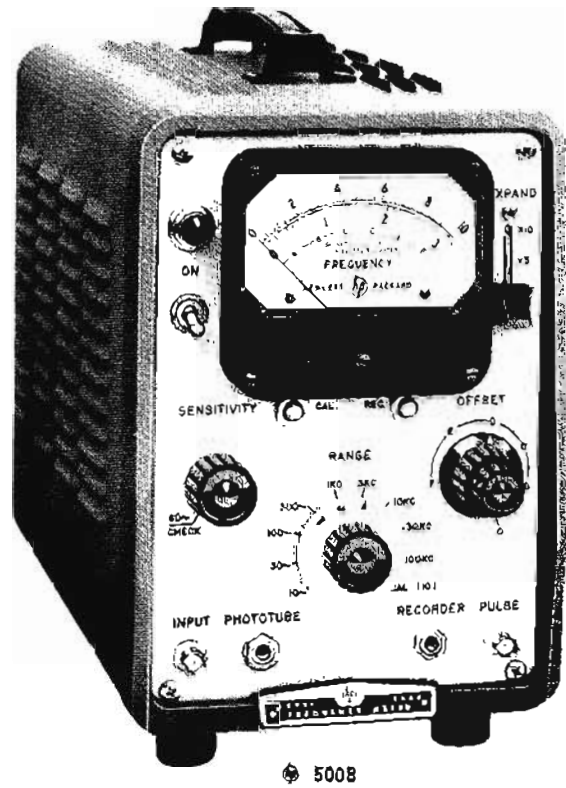

Output Linearity: (Relation of input frequency to output current at the external meter jack.) On 100 kc range: within approx. $\pm 0.25\%$ of full-scale value. On all other ranges: within approx. $\pm 0.1\%$ of full-scale value.

Self-Check: Allows calibration of internal constant current source and check against 60 cps line frequency.

Recorder Output: 1 ma for full scale deflection into 1400 ± 100 ohms.

Pulse Output: To trigger stroboscope, etc., in synchronism with input signal; to measure FM.

Photocell Input: Phone jack on panel provides bias for Type 1P41 Phototube. Allows direct connection of  506A Tachometer Head.

Power: 115 or 230 v $\pm 10\%$, 50 to 1000 cps, 110 watts.

Dimensions: 7 1/2" wide, 11 1/2" high, 14 1/2" deep (cabinet); 19" wide, 7" high, 13" deep behind panel (rack mount).

Weight: Net 17 lbs. Shipping 22 lbs., (cabinet). Net 20 lbs. Shipping 32 lbs. (rack mount).

Accessory Furnished: hp 10501A Cable.

Accessories Available: hp 506A Optical Tachometer, \$150. hp 508A,B,C,D Tachometer Generators, \$125 each. hp 500B-95A Accessory Meter for remote indication (operates from recorder jack), \$55.

Price: hp 500B, \$300 (cabinet); hp 500BR, \$305 (rack mount).

Specifications 500C

Model 500C Frequency Meter is identical in construction and circuitry to hp 500B, but is calibrated in rpm for greater convenience in tachometry applications.

Speed Range: 180 rpm (15 rpm with multiplying transducer) to 6,000,000 rpm, 9 ranges.

Accessory Available: hp 500C-95A Accessory Meter, \$55.

Price: hp 500C, \$300 (cabinet); hp 500CR, \$305 (rack mount).

Data subject to change without notice.

**hp 506A, 508A/B/C/D
TRANSDUCERS**

hp 508 Tachometer Generators

Models 508A,B,C,D, Tachometer Generators are rotational speed transducers for use with electronic counters or frequency meters in making fast, accurate rpm measurements, 15 to 40,000 rpm. They are specifically designed to operate with *hp* electronic counters and frequency meters.

The 508A produces 60 output pulses per shaft revolution. Thus, connected to an instrument calibrated in cps, it converts calibration to rpm. Relationship between output voltage and shaft speed is virtually linear up to 5000 rpm. The 508B, C and D are identical to the 508A except that they produce 100, 120, and 360 pulses, respectively, per shaft revolution, and their output voltages peak at successively slower shaft speeds.

Specifications

Shaft Speed Range: 508A, 15 to 40,000 rpm; 508B, 30 to 30,000 rpm; 508C, 40 to 25,000 rpm; 508D, 50 to 5000 rpm.

Output Frequency: 508A, 60 cycles/rev.; 508B, 100 cycles/rev.; 508C, 120 cycles/rev.; 508D, 360 cycles/rev.

Drive Shaft: 1/4" diameter, projects 19/32".

Running Torque: Approximately 0.15 in.-oz.; 1/2 in.-oz. at 1500 rpm.

Peak Starting Torque: Approximately 4 in.-oz.

Dimensions: 2-7/16" high, 3 1/2" wide, 3 3/4" deep.

Weight: Net 2 lb. Shipping 3 lbs.

Price: *hp* 508A,B,C,D, \$125 each.

hp 506A Optical Tachometer

Model 506A is a light source and photocell for use as a transducer with instruments such as *hp* 521 series Electronic Counters, *hp* 500B Electronic Frequency Meter and *hp* 500C Electronic Tachometer Indicator. The instrument will measure up to 300,000 rpm and will measure speed of moving parts which have small energy or cannot be connected mechanically to measuring devices. The instrument receives light from a rotating part (prepared with alternate reflecting and absorptive surfaces), and the interrupted light is converted into electrical impulses by a phototube.

Specifications

Range for Direct Reading: 1 to 5000 rps with *hp* 521 Series; 3 to 5000 rps with 500B; 180 to 300,000 rpm with 500C.

Lower speed may be measured by using a multi-segment reflector.

Output Voltage: At least 1 v rms, 300 to 100,000 rpm (into 1 megohm or more impedance) with reflecting and absorbing surfaces 3/4" square.

Light Source: 21 candlepower, 6 v automotive bulb.

Phototube: Type 1P41.

Phototube Bias: +70 to +90 v dc (supplied by 500 B,C, 521).

Power: 115 or 230 volts \pm 10%, 50 to 1000 cps, 25 watts.

Dimensions: 22" high, 11" wide, maximum.

Weight: Net 10 lbs. Shipping 16 lbs.

Accessories Available: *hp* 56A-16B Adapter Cable (connects *hp* 506A to *hp* 522B Counter), \$40.

Price: *hp* 506A, \$150.

Data subject to change without notice.

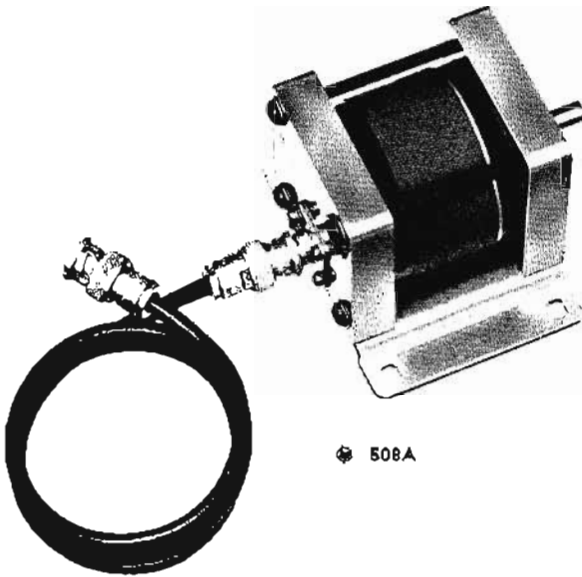

hp 508A



hp 506A

FREQUENCY AND TIME STANDARDS

Frequency and time standards control electronic navigation systems, missile and satellite tracking stations, widely scattered earth science research stations and precision radio transmissions — as well as providing frequency and time "yardsticks" for research laboratories and manufacturing plants. Because units of time or frequency cannot be kept in a vault for reference purposes, frequency and time standards require regular comparisons to a recognized primary standard to maintain their accuracy.

Hewlett-Packard offers frequency and time standard systems which not only provide locally generated frequencies and time intervals, but also include means for relating these frequencies and time intervals to frequency/time standards such as the United States Frequency Standard.

Hewlett-Packard's frequency and time standard systems are well suited for use in seagoing vessels, aircraft and trucks, as well as for general laboratory and field use. They are characterized by small size, moderate weight, low power requirements, extended standby operation and the ability to withstand a wide range of environmental conditions.

While accuracy may be the primary concern, the degree to which a high-accuracy system is useful is a direct function of system reliability. For this reason, increased accuracy and increased reliability are considered inseparable design objectives at Hewlett-Packard. Necessary equipment characteristics provided by Hewlett-Packard systems are: (1) suitable oscillator stability, (2) high-accuracy comparison capability, (3) reliability and (4) operational simplicity.

Frequency Standards

Standard broadcast stations make national standards of time and frequency available throughout the world. In the United States, the Bureau of Standards and the Navy operate standards stations whose frequencies are maintained as constant as possible with respect to the United States Frequency Standard.

The ease with which required system accuracy may be achieved locally depends primarily on the stability of the oscillator used as the local standard. Improved long-term stability directly

increases the permissible time between oscillator adjustments required to maintain a given absolute accuracy.

Long-term stability of the *hp* Quartz Oscillators is conservatively rated at ± 5 parts in 10^{10} per day with substantially better performance expected under normal operating conditions. Models 107AR and 107BR provide even higher stability. Such performance results from use of (a) carefully tested, high-quality crystals, (b) precision temperature-controlled ovens, (c) inherently stable circuitry and (d) low-power dissipation in the crystal (approximately 0.2 microwatt). Design of the Hewlett-Packard

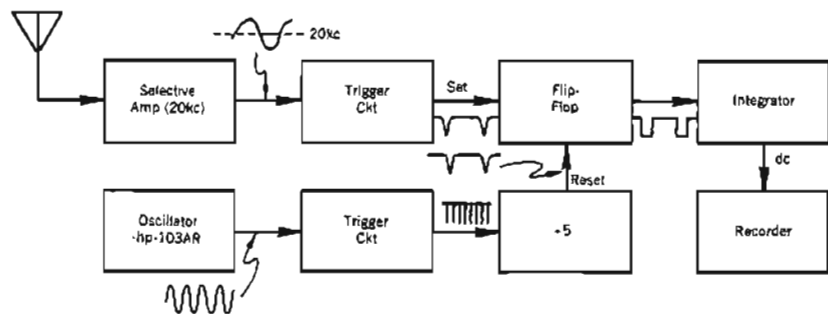

Figure 1. VLF frequency comparison system.

oscillators includes attention to such details as shock and vibration isolation, shielding, load isolation and stability with respect to variation of supply voltage.

In addition to good long and short-term stability, many applications also require a signal having high spectral purity. This is essential, for example, where a high order of frequency multiplication is performed. The *hp* Models 104AR and 107AR, BR were designed specifically for these applications. Spectra less than two cycles wide may be obtained in the X-band region by multiplication of their 5 mc output. Signal-to-noise ratios of 23 db or better, as measured in a 6 cps bandwidth, typically may be obtained at 10 gc with the 104AR.

Hewlett-Packard frequency and time standard systems can be used in several configurations, depending both on principal systems use (i.e., providing accurate frequency or providing accurate time) and on the source of master or frequency signals (i.e., hf radio transmission or lf/vlf radio transmissions). Various system arrangements are discussed in the following paragraphs.¹

Frequency Comparison Using VLF Transmissions

The lf and vlf standard frequency broadcasts, by propagating on a ground wave, avoid the slight shifts in frequency that stem from changes in ionospheric reflections and are characteristic of hf broadcasts. Thus, lf and vlf broadcasts have become the preferred medium for frequency standard transfer. A straightforward vlf frequency comparison system, for comparison with WWVL, is shown in Fig. 1.

In this system, the 20 kc vlf standard broadcast signal is suitably amplified

and filtered. Schmitt trigger and shaping circuits derive a 20 kc pulse train from the vlf signal for triggering the phase-comparator flip-flop. The 100 kc output of the local frequency standard likewise is converted to a pulse train, divided to 20 kc by a quinary counter and used to "reset" the flip-flop.

The width of the flip-flop output pulse is proportional to the phase difference between the received vlf and derived 20 kc signals. These pulses are converted to slowly varying dc in the RC integrator, which has a relatively long time constant (5-second). The dc is applied to the recorder, the resulting chart showing local oscillator frequency with respect to the reference signal. The drift rate can be estimated from the change in slope of the recording. This information can be used in determining the correction factor for the local oscillator. The fine tuning adjustment of the 103, 104AR oscillators has a digital indicator calibrated in parts in 10^{10} , which facilitates making these corrections.

¹A complete discussion of frequency and time standards is included in *hp* Application Note No. 52.

Other combinations of instruments are possible, depending on the user's requirements and the availability of other equipment in the laboratory. For instance, the vlf system shown in Fig. 2 uses the *hp* 115BR Frequency Divider and Clock, driven by the local oscillator. Its output pulses are used as the

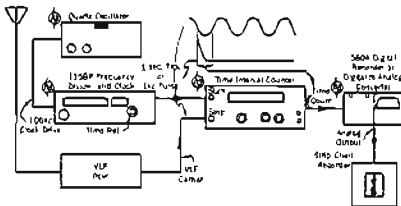

Figure 2. VLF frequency using 115BR Frequency Divider, Clock and digital electronic counter.

start triggers of a time interval measurement in the counter. The time interval measurement is stopped by the zero-axis crossing of the next-occurring cycle of the signal from the vlf receiver. The counter reading is proportional to the phase difference between the local oscillator and the received standard and is converted to an analog voltage in the *hp* 560A Digital Recorder or a digital-to-analog converter for operation of the strip-chart recorder.

HF Time Comparison Methods and Clock Synchronization

If accurate time-keeping is of paramount importance, the high frequency standard broadcasts can synchronize a local clock to an accuracy of better than 1 millisecond. Suggested equipment for calibrating a local clock is shown in Fig. 3.

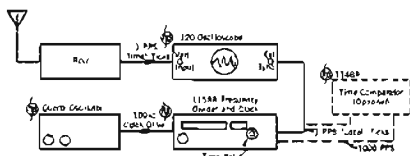

Figure 3. Time comparison for frequency standard calibration.

"Time ticks" (typically 5 msec bursts of an audio frequency at 1 sec intervals) from a standard broadcast of precise time signals are detected by the receiver and applied to the vertical input of the oscilloscope. The *hp* 115BR Frequency Divider and Clock derives "local ticks" from the output frequency of the

103AR Quartz Oscillator². The "local ticks" are used to trigger the oscilloscope horizontal sweep.

At the beginning of a test, the "time tick" and "local ticks" may be as much as 1/2 second apart. By successive adjustment of the 115BR and the oscilloscope sweep speed, a reference condition is established in which the time between the two ticks is very short and is known accurately. The Time Reference control on the clock is adjusted to re-establish the reference condition during subsequent tests.

HF time comparison techniques, although serving primarily for clock synchronization, are also used for frequency transfer. The amount by which the Time Reference control on the clock must be adjusted to re-establish the reference condition indicates the time drift of the local oscillator. By plotting the data obtained over a period of time, drift rate and frequency error may be determined accurately and the oscillator frequency can be readjusted to keep it within predetermined accuracy limits. This method requires several days to achieve a high degree of precision, in contrast to vlf techniques which require less than 24 hours. Time comparisons made by hf techniques over several days can yield a comparison accuracy of a few parts in 10¹⁰.

Reliability and Fail-Safe Operation

Minimum down-time in any system is important, but the accuracy attained in a frequency or time standard depends directly on continuity of operation. Furthermore, the system must be fail-safe to prevent the accumulation of insidious frequency or time errors. Hewlett-Packard frequency and time standards employ simplified, optimized designs which display a high order of inherent dependability.

Fail-safe operation results mainly from three Hewlett-Packard equipment characteristics: (1) a standby power supply employs batteries to provide continued operation in event of line failure; (2) dividers in *hp* quartz oscillators and frequency divider and clock will not respond to spurious signals, and (3)

the divider output signals stop and remain stopped upon any interruption of driving signal or supply power.

Power Supply Considerations

Interruptions in primary power to any quartz oscillator can cause serious changes in output frequency. If the power interruption is of sufficient length, cooling causes strains in the crystal which can cause a frequency offset and which may alter the aging rate. The new aging cycle thus incurred may last for days or even weeks, since the strains can be relieved only with time at the proper operating temperature. Because the accuracy attained in time comparison measurements depends directly on the length of time over which the measurements are made, power interruptions to comparison equipment, such as the frequency divider and clock, are also undesirable.

Hewlett-Packard standby power supplies, operating over wide ranges of ac line voltage and frequency, supply regulated dc to operate the quartz oscillator and frequency divider and clock. The batteries in the supplies assume the load immediately, without switching or undesirable transients, whenever ac line power fails. When line power is restored, the supplies immediately re-assume the load and automatically recharge the batteries. Alarm systems include local indication of operating conditions and provisions for remote alarms.

Fail-Safe, Regenerative Dividers

To insure that short interruptions in power or other irregularities do not affect the time indication, *hp* frequency and time standard equipment uses regenerative frequency dividers. These circuits, if ever interrupted, will not restart unless triggered by a push-button starter.

Sharp tuning makes *hp* regenerative dividers virtually invulnerable to noise bursts or other spurious signals which would cause pulse counters or phantatron dividers to "gain" in time. Since properly designed regenerative dividers have no output in the absence of an input signal, the presence of output from a regenerative divider of the non-selfstarting type is a positive indication that the divider output has not "lost" time with respect to the driving signal.

²Dexter Hartke, "A New Clock for Improving the Accuracy of Local Frequency and Time Standards". *Journal*, vol. 11 No. 3-4, Nov. - Dec., 1959.

5100A - 5110A FREQUENCY SYNTHESIZER

Ideal System for Precise Frequency Generation

Advantages

- 0.01 cps to 50 mc output in 0.01 cps steps
- Excellent frequency stability
- Outstanding spectral purity
- Electronic programming and readout
- Frequency selection in less than one millisecond
- All solid-state modular construction
- Failsafe—only 1 mc crystal standard and search oscillator are free running
- Premium quality throughout; easy to service
- Easily operated by non-technical personnel
- Constant output, 1 volt rms into 50 ohms (50 cps to 5 mc)
- Low distortion

The Hewlett-Packard 5100A-5110A Frequency Synthesizer provides an output frequency adjustable from 0.01 cps to 50 mc in steps as fine as 0.01 cps. The selected output frequency is derived from a single-frequency source by direct synthesis techniques, hence the accuracy of the selected output frequency depends only on the accuracy of the driving source. An extremely stable quartz oscillator is provided, but the Frequency Synthesizer may be driven by an external 1 mc or 5 mc standard.

Particular care has been taken with Model 5100A-5110A to obtain a very clean output signal over the full frequency range. A high order of spectral purity is essential for accurate doppler measurements, microwave spectroscopy, narrow band telemetry or communications, and similar applications. The design and construction of the Synthesizer makes it possible to obtain output signals whose spurious content is 90 db or more below the selected output. Frequency deviation (exclusive of the driving source) for one-second measurement times is less than 2 parts in 10^{11} at 50 mc. Signal-to-noise ratio in a 3 kc band centered on the signal is more than 60 db. Furthermore, because Model 5100A-5110A is all solid state and ruggedly built, microphonics are minimized.

Since the output signal of this instrument is derived by a series of arithmetic manipulations which do not involve phase locked loops, switching from one output frequency to another can be accomplished very rapidly. Less than one millisecond, including all dead time and transients, is required to change output frequency. For applications requiring rapid frequency selection, Model 5100A-5110A is arranged for remote programming through rear connectors. A separate connection is made for each numeral in each digit column. Simple contact closures are all that are needed for remote frequency selection.

For local control of the Synthesizer, the output frequency is selected by 10 columns of pushbuttons which are ar-

anged for rapid frequency selection. A locking switch is provided to prevent accidental operation of the pushbuttons. A local-remote switch determines control precedence where both methods are employed. It is also possible to make use of combined programming so that some of the digit columns are controlled locally and the rest remotely.

A voltage-tuned search oscillator may be substituted to allow continuously variable frequency selection with an incremental range of 0.1 cps up to 1 megacycle, depending upon the digit position being searched. The search oscillator may be varied either by a front panel dial, or by application of a dc control voltage. The full range of any digit position may be swept at a rate of at least 1000 times per second with full specified linearity. In addition to the search function, this voltage-tuned oscillator is also useful for frequency modulating the output.

The internal frequency standard for this Synthesizer is a one megacycle quartz oscillator with a specified drift rate of less than 3 parts in 10^9 per day. Output of the oscillator is filtered to limit the noise band width of the driving signal supplied to the Synthesizer circuitry. Excellent short-term stability and low susceptibility to changes in temperature and line voltage are characteristic of the oscillator. Provisions have been made for phase locking the internal oscillator with an external reference. The Synthesizer may also be driven by an external one megacycle or five megacycle input.

The Frequency Synthesizer is composed of the *hp* 5100A Frequency Synthesizer, Variable Frequency Section, and the *hp* 5110A Frequency Synthesizer, Fixed Frequency Section. Model 5110A includes the internal 1-megacycle quartz oscillator, a comb generator, and a series of filter-divider units. The 5110A provides fixed driving frequencies to the 5100A. Buffered outputs of the 5110A are available for driving up to four Model 5100A's simultaneously.

The *hp* 5100A, when driven with the fixed frequency inputs from Model 5110A, provides independent digital synthesis of the selected output signal. The output is one volt rms into 50 ohms in 0.01 cps steps from 50 cps to 50 mc. A separate output extends the range down to 0.01 cps at a level of approximately 15 mv rms into an open circuit.

The versatility and performance characteristics of the 5100A-5110A Frequency Synthesizer make it suitable for a great many applications. As a general purpose source of a precisely known, spectrally pure signal frequencies, it will find a growing number of everyday uses throughout the factory and the laboratory. The remote programming capability helps make it ideal for a variety of automatic measurement systems such as filter and transmission line test sets. The Frequency Synthesizer also offers unique advantages for specialized applications in communications, telemetry, and radar.

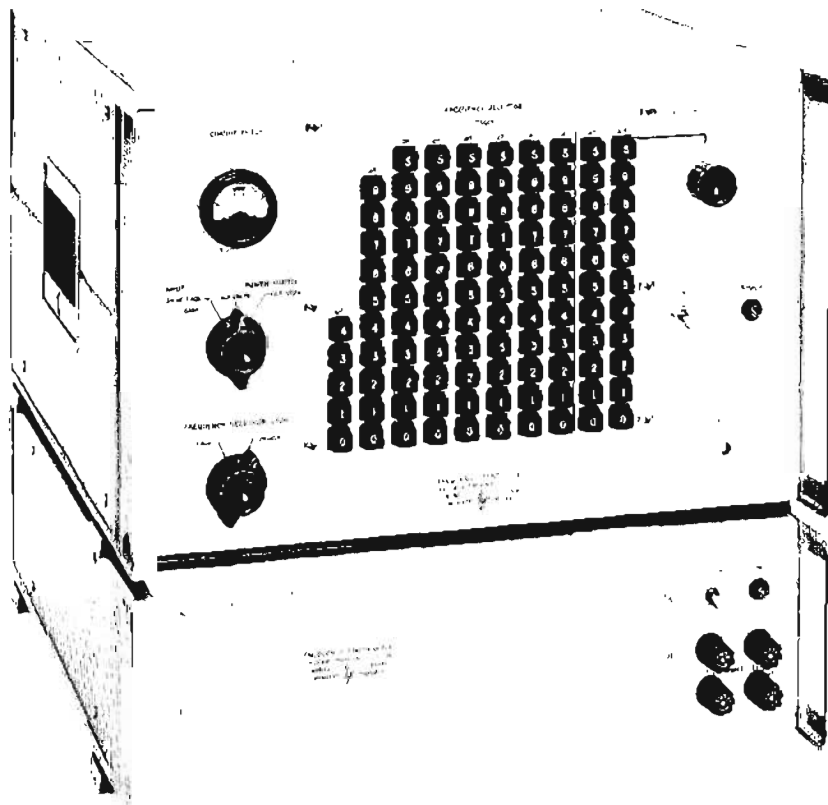

NEW IN THIS
CATALOG

⊗ 5100A Frequency Synthesizer, Variable Frequency Section (top)

⊗ 5110A Frequency Synthesizer, Fixed Frequency Section (bottom)

Specifications

Output Frequency: 50 cps to 50 mc; a high impedance output provides 0.01 to 50 cps (15 mv rms open circuit).

Digital Frequency Selection: From 0.01 cps per step to 10 mc per step. Selection is by front panel pushbutton or by remote contact closure. Any change in frequency can be accomplished in less than 1 millisecond.

Spurious Signals: Non-harmonically related signals are more than 90 db below the selected frequency.

Harmonic Distortion: Less than 30 db; typically less than 40 db for output frequencies up to 20 mc.

Signal to Phase Noise Ratio: More than 60 db down in a 3 kc band centered on the signal (AM noise further down than phase noise).

RMS Fractional Frequency Deviation (exclusive of 1 mc crystal standard)

Averaging Time	Frequency in Megacycles			
	1	5	10	50
10 milliseconds	2×10^{-4}	4×10^{-9}	2×10^{-9}	8×10^{-10}
1 second	2×10^{-10}	4×10^{-13}	3×10^{-11}	2×10^{-11}

Aging Rate: Less than ± 3 parts in 10^9 per day with internal standard; with external standard, same as external standard.

Output Voltage: 1 v rms ± 1 db from 100 kc to 50 mc, 1 v rms ± 2 db from 50 cps to 100 kc into 50-ohm resistive load.

Output Impedance: 50 ohms, nominal.

Search Oscillator: Allows continuously variable frequency selection with an incremental range of 0.1 cps up to 1 mc,

depending on the digit position being searched. Dial accuracy is $\pm 3\%$ of full scale. Linearity with external voltage control is within $\pm 5\%$ (-1 to -11 volts).

External Standard Input: 1 or 5 mc, 0.2 v rms minimum, 5 v maximum across 500 ohms. Purity of output signal will be determined partially by purity of external standard.

Interference: Complies with MIL-I-16910A (SHIPS).

Operating Temperature Range: 0 to $+55^\circ\text{C}$.

Power: *hp* 5100A, 115 or 230 v $\pm 10\%$, 50 to 1000 cps, 35 watts.

hp 5110A, 115 or 230 v $\pm 10\%$, 50 to 1000 cps, 35 watts.

Dimensions: *hp* 5100A, $10\frac{3}{4}$ " high, $16\frac{3}{4}$ " wide, $16\frac{3}{8}$ " deep behind panel; hardware furnished for quick conversion to rack mount (panel 19" wide, $10\frac{1}{2}$ " high).

hp 5110A, $5\frac{1}{2}$ " high, $16\frac{3}{4}$ " wide, $16\frac{3}{8}$ " deep behind panel; hardware furnished for quick conversion to rack mount (panel 9" wide, $5\frac{1}{4}$ " high).

Weight: *hp* 5100A, Net 75 lbs. Shipping 90 lbs. *hp* 5110A, Net 52 lbs. Shipping 68 lbs.

Additional Data: The 1 mc standard has a voltage control feature allowing 5 parts in 10^8 frequency control for phase locking the synthesizer to some other source. The 5100A and 5110A have independent power supplies.

Price: 5100A Frequency Synthesizer, Variable Frequency Section, \$10,250. 5110A Frequency Synthesizer, Fixed Frequency Section, \$5000.

Data subject to change without notice.

hp 100E FREQUENCY STANDARD

5/10⁸ Stability, Multiple Outputs For Test, Production or Lab Use

Good stability and the versatility of a wide variety of outputs are offered by the \textcircled{h} 100E Frequency Standard.

This compact instrument provides six standard sine and four pulse signals for use at many different stations on a production line or in the laboratory.

A particularly useful feature of 100E is a timing comb providing output pips at 100, 1,000, and 10,000 μsec intervals to simplify sweep and time interval measurements.

Model 100E includes a built-in oscilloscope which may be used to calibrate external equipment such as oscillators through use of Lissajous figures or to check the Standard's internal frequency division.

Specifications

Stability: Short term ± 3 parts in 10^8 . Long term ± 5 parts in 10^8 per week.

Output Frequencies: Sinusoidal, 10 cps, 100 cps, 1 KC, 10 KC, 100 KC and 1 MC. Pulse 10 cps, 100 cps, 1 KC and 10 KC.

Output Voltages: Sinusoidal 5 v rms minimum into rated load. Pulse approx. 15 v peak-to-peak into rated load. Harmonics to 5 MC from 10 KC pulses.

Rated Load: 50 ohms nominal, 100 KC and 1 MC. 5,000 ohms nominal, 10 cps, 100 cps, 1 KC and 10 KC.

Source Impedance: Approx. 50 ohms, 100 KC and 1 MC. Approx. 300 ohms, 10 cps, 100 cps, 1 KC and 10 KC.

Distortion: (Sinusoidal) Less than 4% into rated load.

Timing Comb: Marker pips at 100 μsec intervals. Double amplitude pips at 1,000 μsec , triple amplitude pips at 10,000 μsec intervals.

Oscilloscope: Vertical sensitivity adjustable, maximum approx. 3 v rms/inch. Vertical bandwidth approx. 100 cps to 1 MC. Horizontal sensitivity adjustable, maximum approx. 2 v rms/inch. Horizontal bandwidth approx. 20 cps to 150 KC.

Frequency Shifter: Panel pushbutton lowers oscillator frequency approx. 0.1 cps at 1 MC to aid in frequency comparisons.

Power: 115 or 230 v $\pm 10\%$, 50 to 1,000 cps, 140 watts.

Dimensions: Cabinet Mount, 11 $\frac{1}{4}$ " high, 20 $\frac{1}{2}$ " wide, 18 $\frac{3}{8}$ " deep. Rack mount, 8 $\frac{3}{4}$ " high, 19" wide, 16 $\frac{3}{8}$ " deep behind panel.

Weight: Net 35 lbs. Shipping 56 lbs., (cabinet). Net 32 lbs. Shipping 49 lbs. (rack mount).

Price: \textcircled{h} 100E, \$1,000 (cabinet); \textcircled{h} 100ER, \$975.00 (rack mount).



\textcircled{h} 100E

hp 101A 1 MC OSCILLATOR

5/10⁸ Stability For Electronic Counter Time Base

Designed specifically to be the time base for \textcircled{h} 5275A Electronic Time Interval Counters, the high precision capabilities and low cost of \textcircled{h} 101A make it useful for many other applications as well. This 1 MC oscillator can be used directly to obtain increased accuracy from counters such as \textcircled{h} 523C,D. A 100 KC output is available for use with counters such as \textcircled{h} 524B, FR-38U, AN/USM-26, and for other suitable applications.

Model 101A provides an output of at least 1 volt into a 50 ohm load, sufficient to drive a number of electronic counters. Model 101A has a long-term stability of 5 parts in 10^8 per week and is a transistorized version of the proven oscillator used in \textcircled{h} 524C,D Electronic Counters and \textcircled{h} 100E Frequency Standard.*

* \textcircled{h} Journal, Vol. 10, No. 3-4, Nov. - Dec. 1958 "5 x 10^{-8} /Week Time Base Accuracy in the 10 MC Frequency Counter."

Specifications

Stability: Short term, ± 3 parts in 10^8 . Long term, ± 5 parts in 10^8 per week.

Output Frequencies: Sinusoidal, 1 MC and 100 KC, BNC connectors.

Output Voltages: 1 v rms minimum into 50 ohm load.

Source Impedance: Less than 30 ohms.

Distortion: Less than 4% into rated load.

Oven Temperature Indicator: Front panel dial thermometer.

Frequency Adjustment: Front panel screwdriver adjustment with range of approximately 1 part per million for calibration from primary standards.

Power: 115 or 230 v $\pm 10\%$, 50 to 1,000 cps, approx. 9 watts average.

Dimensions: 3 $\frac{1}{2}$ " high, 16 $\frac{3}{4}$ " wide, 11 $\frac{1}{2}$ " deep behind panel.

Weight: Net: Approximately 10 lbs. Shipping 19 lbs.

Accessories Furnished: \textcircled{h} 10503A 4' cable assembly, BNC connectors; rack mounting hardware.

Price: \textcircled{h} 101A, \$500.00.

Data subject to change without notice.

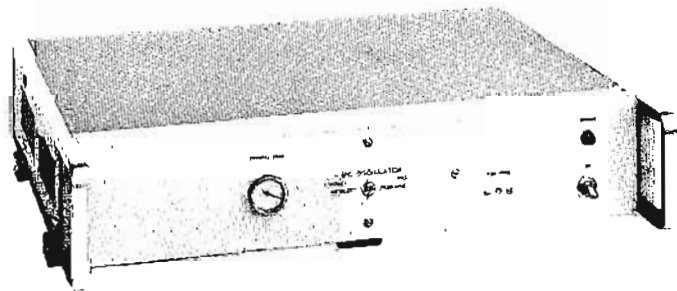

\textcircled{h} 101A

hp 103AR, 104AR QUARTZ OSCILLATORS

5 Parts in 10^{10} /Day Stability; Short-Term Typically 1 Part in 10^{10} *

Specifications

Ⓢ 103AR and 104AR Quartz Oscillators make possible improved accuracy in Primary Frequency and Time Standard systems because they provide increased stability, maximum reliability and are easy to adjust.

Long-term stability of Ⓢ 103AR and 104AR is conservatively rated at 5 parts in 10^{10} /day. Short-term stability, specified as 5 parts in 10^{10} *, includes effects of variations in supply voltage, load resistance, ambient temperature and other environmental conditions. Models 103AR and 104AR typically display short-term stability of one part in 10^{10} when operated in a reasonably constant environment.

Model 103AR provides two sinusoidal output signals, 1 MC and 100 KC, from a low source impedance at a power level well suited for distribution over 50-ohm systems. A separate 100 KC output is available for driving an Ⓢ 113 or an Ⓢ 115 Frequency Divider and Clock for time comparison measurements and for generating time signals.

Proportionally-controlled double ovens house the crystal and all critical frequency-determining elements and maintain their temperature constant within a few hundredths of a degree. Crystal dissipation level is kept constant at less than $\frac{1}{4}$ microwatt by AGC action. Frequency changes due to variations in supply voltage and load impedance are virtually eliminated as a result of internal voltage regulation and excellent buffering.

Completely transistorized, Ⓢ 103AR and 104AR Quartz Oscillators are compact and rugged, withstand severe environmental conditions and operate for extended periods from standby batteries of moderate size.

Model 104AR has the same high stability as Ⓢ 103AR and in addition provides a 5 MC output of extreme spectral purity. Spectra only a few cycles wide in the gigacycle region may be obtained by multiplication of this 5 megacycle output.

*Averaged over 1 second intervals.

Aging Rate: $< \pm 5$ parts in 10^{10} per 24 hours †
 Stability: As a function of input voltage: $< \pm 1$ part in 10^{10} for changes of ± 4 v from 26 v dc; as a function of load: $< \pm 1$ part in 10^{10} for any load impedance change from 50 ohms; as a function of ambient temperature: $< \pm 3$ parts in 10^{10} for changes of $\pm 25^\circ\text{C}$ from 25°C .

RMS Deviation due to noise and frequency fluctuations of 1 and 5 mc output and RMS Phase Deviation of 5 mc output. (Constant input voltage, load and temperature):

Averaging Time	1 mc output RMS Deviation	5 mc output (104AR only)	
		RMS Deviation	RMS Phase Deviation‡
1 ms	1×10^{-7}	5×10^{-9}	1.6×10^{-4} radian
10 ms	1×10^{-8}	5×10^{-10}	1.6×10^{-4} radian
0.1 sec	1×10^{-9}	1×10^{-10}	3.2×10^{-4} radian
1.0 sec	1×10^{-10}	5×10^{-11}	1.6×10^{-3} radian
10.0 sec	5×10^{-11}	5×10^{-11}	1.6×10^{-3} radian

Output Frequencies: 103AR and 104AR: 1 MC, 100 KC, 1 v rms into 50 ohms; 100 KC for driving 113BR or 115BR. 104AR: 5 MC, 1 v rms into 50 ohms.

Harmonic Distortion: At least 40 db below rated output.

Non-Harmonically Related Output: At least 80 db below rated 1 MC output, 66 db below rated 5 MC output (104AR).

Output Terminals: 103AR and 104AR: 1 MC, 100 KC, front and rear BNC connectors. Clock drive 100 KC, rear BNC. 104AR: 5 MC front and rear BNC connectors.

Frequency Adjustments: Coarse: Approx. 1.5 parts in 10^6 ; Fine: approx. 600 parts in 10^{10} . Digital indicator calibrated directly in parts in 10^{10} .

Monitor Meter: Ruggedized front-panel meter and associated selector switch monitors circuit operation.

Temperature Range: 0 to 50°C .

Size: Rack Mount: $5\frac{1}{4}$ " high, 19" wide, $12\frac{1}{8}$ " deep behind panel, including cable allowances. 14" deep overall.

Weight: 103AR, net 17 lbs., shipping 32 lbs. 104AR, net 17 lbs., shipping 28 lbs.

Power Requirements: 22 to 30 v dc, approx. 5 watts operating, approx. 10 watts during warmup. Dual power connectors at rear.

Accessories Furnished: 6' power cable for connecting quartz oscillator to Ⓢ 724BR or 725AR Standby Power Supplies.

Price: Ⓢ 103AR, \$1,900.00 (rack mount); Ⓢ 104AR, \$2,300.00 (rack mount).

†Achieved within 21 days of continuous operation.

‡Phase deviation at higher frequencies for a given averaging time directly proportional to the multiplying factor.

Data subject to change without notice.

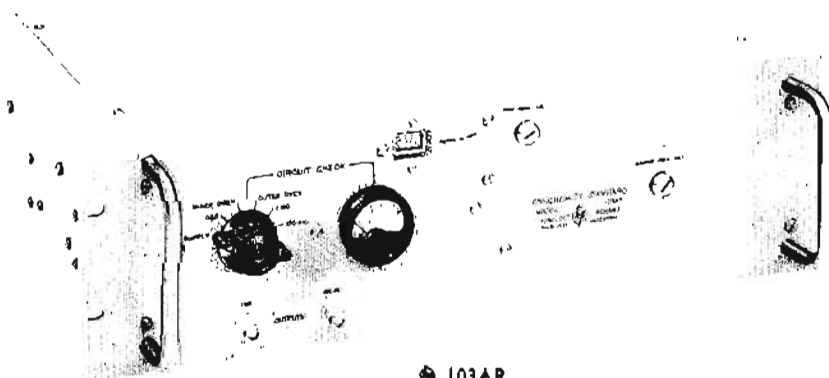

Ⓢ 103AR

hp 107AR, 107BR QUARTZ OSCILLATORS

Hewlett-Packard Models 107AR and 107BR are rugged, hermetically sealed, precision quartz oscillators for frequency and time standards. Model 107AR operates from 26 ± 4 v dc; Model 107BR operates from the ac line and includes a 2-hour standby battery. Both instruments provide sinusoidal signals of 5 mc, 1 mc and 100 kc with excellent short term stability and long term drift rate. They operate over a wide range of environmental conditions.

Models 107AR and 107BR have been prototype-tested to conform to the shock and vibration requirements of MIL-E-16400D. MIL-E-16400D subjects the instrument to vibration at 5 to 33 cps rates with excursions from 0.03 to 0.01 inch in each of three mutually perpendicular planes. Under the shock test the instrument receives nine blows from a 400 pound hammer. Blows are from one foot, three, and five feet in each of three planes.

Particular care was taken to provide a spectrally pure 5 mc output which, when multiplied high into the microwave region, provides signals with spectra only a few cycles wide. Spectra less than 1 cps wide can be obtained in X-band (8.2 to 12.4 gc). The stability and purity of the 5 mc output makes it suitable for doppler measurements, microwave spectroscopy and similar applications where the reference frequency must be multiplied by a large factor.

Provision also has been made in the 107AR and 107BR Quartz Oscillators so that they can be voltage controlled; therefore these oscillators can be used in phase-locked systems. The sensitivity of this automatic frequency control is such that a change from -4 to $+4$ volts will change the output by 2 parts in 10^8 .

Specifications

Models 107AR and 107BR

Aging Rate: $< \pm 5$ parts in 10^{10} per 24 hours¹.

Stability:

As a Function of Ambient Temperature: $< \pm 1 \times 10^{-10}$ from 0° to $+50^\circ\text{C}$.

As a Function of Humidity: Instruments are hermetically sealed.

As a Function of Load: $< \pm 2 \times 10^{-11}$ for any resistive load change.

As a Function of Supply Voltage (107AR): $< \pm 5 \times 10^{-11}$ for 22 to 30 v dc.

As a Function of Line Voltage (107BR): $< \pm 1 \times 10^{-11}$ for $\pm 10\%$ change from 115 or 230 v ac.

RMS Deviation of 5 MC Output (due to noise and frequency fluctuation):

Averaging Time	RMS Fractional-Frequency Deviation ($\Delta f/f$)	RMS Phase Deviation (milliradians)
1 msec	8×10^{-10}	0.03
10 msec	1.5×10^{-10}	0.04
0.1 sec	1.5×10^{-11}	0.04
1 sec	1.5×10^{-11}	0.4
10 sec	1.5×10^{-11}	4

All data is based on at least 100 samples. Data was taken over a 20-second interval for 1 msec, 10 msec and 0.1 sec averaging times, over 200- and 2000-second intervals respectively, for 1 and 10 sec averaging times. The crystal aging rate has been removed from this data.

Signal-to-Noise Ratio (5 mc): 87 db below rated 5 mc output; output filter bandwidth is 150 cps maximum.

Harmonic Distortion (5 mc, 1 mc and 100 kc): Down more than 40 db from rated output.

Non-Harmonically Related Output (5 mc, 1 mc and 100 kc): Down more than 80 db from rated output.

Output Terminals: 5 mc, 1 mc, 100 kc, front and rear BNC connectors. 100 kc clock drive, rear BNC connector.

Frequency Adjustments:

Fine Adjustment: 5 parts in 10^8 total; 1 part in 10^9 per revolution; 1 part in 10^{10} per division at 10 divisions per revolution.

Coarse Adjustment: 350 parts in 10^8 .

Coarse and fine controls are screwdriver adjustments, recessed from front panel.

Monitor Meter: Ruggedized front panel meter and associated selector switch monitors: Supply voltage, $+18$ volts, Osc voltage, Inner Oven current, Outer Oven current, 5 mc output, 1 mc output, 100 kc output.

Environmental:

Storage Temperature: -62°C to $+75^\circ\text{C}$. (Manufacturer specifies -50°C limit for 107BR battery.)

Operating Temperature: 0°C to $+50^\circ\text{C}$.

Humidity: Instrument is hermetically sealed, will operate under water without degradation of performance.

Vibration and Shock: Prototype units of Model 107AR and 107BR have completely passed vibration and shock requirements of MIL-E-16400D.

Altitude: 50,000 feet (non-operating), 20,000 feet (operating).

Weight: Model 107AR, Net, approx. 20 lbs. Model 107BR, Net, approx. 35 lbs.

Dimensions: $5\frac{1}{4}$ " high, 19" wide, $16\frac{1}{2}$ " deep.

Power:

Model 107AR: 22 to 30 v/dc, approximately 12 watts operating, 15 watts during warmup.

Model 107BR: 115 or 230 v ac $\pm 10\%$, 50 to 100 cps, approximately 25 watts operating with battery on trickle charge (30 watts on fast charge) 33 watts during warmup (38 watts on fast charge.)

Price: Prices on request.

¹No instrument is shipped until it exhibits an aging rate $< \pm 5 \times 10^{-10}$ per 24 hrs.



107AR

hp 115BR, 115CR FREQUENCY DIVIDER AND CLOCK

Increased Accuracy from Frequency/Time Standards

NEW IN THIS
CATALOG

The Model 115BR or 115CR Frequency Divider and Clock permits adjustment of frequency or time standards for maximum absolute accuracy by making precise comparisons with broadcast standard time and frequency signals.¹ Detailed records of oscillator drift rates, as well as time or frequency differences between oscillators can be obtained efficiently and conveniently.

Overall time comparison accuracy is $\pm 10 \mu\text{sec}$, and jitter is negligible in the output of these compact battery-operated units. Frequency divider and clock are contained in one rack-mount unit $3\frac{1}{2}$ " high for the 115CR and only $5\frac{1}{4}$ " high for the 115BR. The 115BR is designed to meet performance requirements of MIL-E-16400² and is well suited to mobile applications. For maximum dependability, design is conservative and fail-safe. Premium electrical and mechanical components, derated by substantial margins, insure maximum reliability and long life.

Models 115BR and 115CR are fully transistorized and operate from 26 volts dc. Power requirements are low so they will operate for extended periods from standby batteries of moderate size. hp Models 724BR and 725AR Standby Power Supplies are designed specifically for this task.

For convenience and maximum efficiency in operation, the 115BR and 115CR provide in-line display of time in hours, minutes and seconds, with an additional drum revolving once per second to permit time resolution of 0.1 second or, by stroboscope or camera to 0.01 second. Use of non-self starting regenerative dividers avoids noise and spurious signal problems, for maximum total accuracy. BCD time-of-day information in hours, minutes and seconds and milliseconds is available on special order.

Specifications

Input Frequency: 100 kc for solar time, input bandwidth ± 300 cps. 100.3 kc for sidereal time, on special order.
Input Voltage: 0.5 to 5 volts rms.
Pulse Outputs: (see attached chart).
Accuracy: Same as input frequency.
Input Impedance: 300 ohms nominal.
Auxiliary Output: (115 BR only):
 Amplitude: 0.25 v rms minimum.
 Source Impedance: 1200 ohms (approx.).
 Frequency: 100, 10 and 1 kc (60 cps on special order).
Connectors: BNC (100 and 1 kc at front and rear panels; 10 kc at front panel).

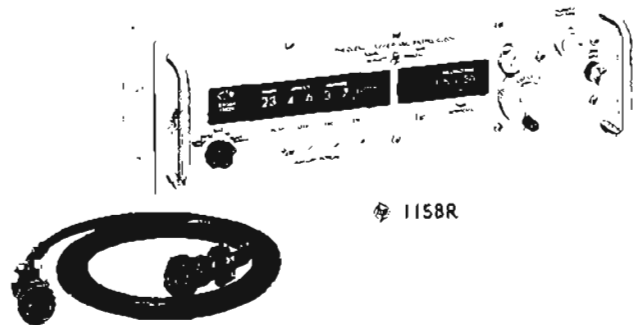

Time Reference: Continuously adjustable, calibrated in 10 μs increments. Numerical display from 999.9 ms to 000.0 ms, in-line vernier in 10 μs increments.

Frequency Divider: Manually started, regenerative type, fail-safe.

Effect of Transients: Will not gain or lose time because of: (1) ± 300 volt step function on 100 kc input; (2) 0 to 50 pulses, 0 to 500 pps, 1 to 10 μsec duration on 100 kc input; (3) ± 4 volt step in 26 v dc input.

Clock Mechanism: 24-hour digital display in hours, minutes, and seconds. Vernier in-line scale allows resolution (stroboscopically) to 0.01 second. Clock is manually started; seconds wheel may be set with clock running without affecting tick output.

Monitor Meter (115 BR only): Ruggedized meter and selector switch on front panel for checking supply voltage, divider operation (100 kc, 10 kc, 1 kc) and total clock current.

Power Required: 22 to 30 v dc, positive ground for operating with hp 103AR or 104AR (see page 157) (neg. ground may be selected by a switch), approximately 2.5 watts, recommended supply, hp 724BR or 725AR (see page 161).

Dimensions: 115BR: 19" wide, $5\frac{1}{4}$ " high, 14" deep behind panel. 115CR: 19" wide, $3\frac{1}{2}$ " high, 12" deep behind panel.

Weight: 115BR: Net 35 lbs. Shipping 51 lbs. 115CR: Net 15 lbs. Shipping 25 lbs.

Accessories Furnished: 113A-16E Cable, 6 feet long, connects 115BR or 115CR to 724BR or 725AR Standby Power Supply.

Price: 115BR, \$2750, 115CR, on request.

¹See hp Application Note 52, available on request.

²See the 115BR data sheet for more detailed information on military environmental tests.

Characteristic	Positive Tick	Negative Tick	Auxiliary Pulse* (115BR only)	Positive† 1-KC Pips
Pulse rate	1 pps	1 pps	1 pps	1000 pps
Amplitude	+ 10 v, min††	- 10 v, min††	+ 4 v min open circuit + 2 v min into 50 ohms	+ 4 v min
Rise Time	2 μsec , max	2 μsec , max	1 μsec , max	2 μsec , max
Duration	20 μsec , min	20 μsec , min	200 μsec	20 μsec , min
Jitter	1 μsec , max	1 μsec , max	1 μsec , max	1 μsec , max
Recommended Load Impedance	4700 ohms min shunted by 200 pf max	1M ohm min shunted by 100 pf max	50 ohms min shunted by 5000 pf max	1000 ohms min shunted by 1000 pf max
BNC Location	rear	front	rear	rear

*Standard for 115B, available for 115CR.

†Negative pulses available on special order.

††For any load impedance higher than minimum recommended.

Data subject to change without notice.

hp 114BR TIME COMPARATOR

Speed, Simplify Frequency or Time Standards Comparisons

The *hp* 114BR Time Comparator provides additional speed and flexibility in making time comparisons between stable oscillators and standard time signal transmissions such as those from WWV. Model 114BR is an auxiliary unit used in conjunction with an *hp* Frequency Divider and Clock and an oscilloscope in primary frequency or time standard systems. The 114BR provides a method of making time comparisons without disturbing outputs from the frequency divider and clock if time signals generated are to be used with computers or for system timing signals or similar purposes.

The *hp* 114BR Time Comparator consists of an adjustable preset digital delay generator, a sweep generator and a marker generator. An oscilloscope such as *hp* 120B is used as an indicator. All critical controls on the 114BR are de-tented selector switches, and time markers are automatically adjusted to sweep speed. As a result, time comparison by means of the 114BR is simple and fast. Adjustment of the 114BR will not affect operation of the frequency or time standard in any way.

The time difference between the received one-per-second standard time signal and the tick output from an *hp* frequency divider and clock can be resolved to ± 10 microseconds, where signal conditions permit. The data thus accumulated over a period of days, weeks or months may be used to determine the long-term drift of the stable frequency source or for time checks in time standard systems.

Specifications

- Sweep Delay Range:** 0 to 999 msec in 1 msec steps with direct reading, in-line front panel switches.
- Sweep Output:** 1000, 100, 10, or 1 msec duration as selected by front panel switch. Sweep may be delayed from 0 to 999 msec in 1 msec steps with direct reading front panel switches. Amplitude 1 volt peak-to-peak, dc coupled. Front panel vernier horizontal position control provides fine adjustment of dc level. Recommended display unit, *hp* 120B Oscilloscope.
- WWV Tick Output:** WWV Tick, gated at 1-second intervals to provide stable base line for intensity markers between ticks, appears at Vertical Axis BNC connector on front panel.
- Z-Axis Output:**
 - Intensity Markers:** Marker intervals automatically adjusted to 1/10 of the sweep duration; length automatically adjusted with sweep time. Markers may be switched on or off by front panel switch.
 - Unblanking Voltage:** 50 kc unblanking square wave synchronized with standard frequency for interpolation to 10 μ sec or better. Amplitude 40 volts peak-to-peak.
- Input Requirements:** 1 kc and 1 pps positive pulses from *hp* Frequency Divider and Clock. WWV Tick, 0.1 to 10 volts peak-to-peak to BNC connector on rear.
- Self Check:** Each digit of delay setting may be checked by means of front panel pushbutton.
- Power Requirements:** 115 or 230 \pm 10% volts ac, 50 to 1000 cps; approximately 7 watts.
- Dimensions:** 3 1/2" high, 19" wide, 13 1/2" deep overall, 11 1/2" deep behind panel, including cable allowance.
- Weight:** Net, 11 lbs. Shipping, 24 lbs.
- Accessories Furnished:** $\text{\textcircled{A}}$ 114BR-16A power cable, 6 feet long, with NEMA line plug; $\text{\textcircled{B}}$ 114BR-16B Z-axis cable, 3 feet long; $\text{\textcircled{C}}$ 114BR-16C Horizontal axis cable, 6 1/2" long; $\text{\textcircled{D}}$ 114BR-16D Vertical axis output cable, 10" long.
- Price:** \$1200 (rack mount).

Data subject to change without notice.

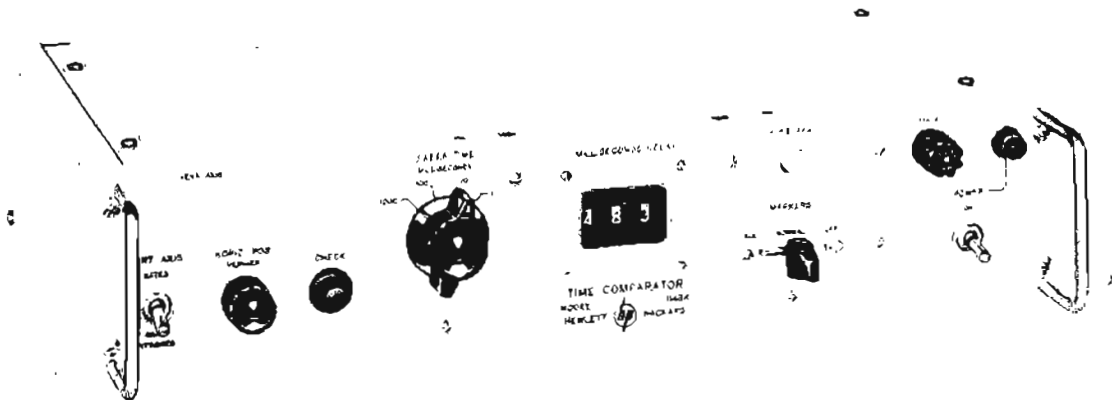

hp 724BR, 725AR STANDBY POWER SUPPLIES

Avoid AC Problems in Frequency, Time Standard Systems

Specifications

Output Voltage: 24 \pm 1 volts dc at rated current.

Rated Current (total external load): 300 ma, nominal.[†]

Over-Current Protection: Current limiter provides short-circuit protection, eliminates need for load fuses.

Alarm Indicators: Panel lamps indicate (1) OPEN AC LINE FUSES, or (2) AC OFF, indicating ac is not reaching power transformer and load is being supplied by standby battery.

Remote Alarm Provisions: DPDT relay contacts (form C) provided at rear terminals for operating remote alarm from separate power system. Contacts rated at 3 amps (resistive) at 115 v ac or 28 v dc.

Panel Meters: Voltmeter and ammeter indicate battery voltage and battery charge/discharge current.

Power Requirements: 115 or 230 \pm 10% v ac, 50 to 1,000 cps.

Output Connectors: MS type female connectors at rear mate with 103AR, 104AR, 113BR, 115BR power cables.

Battery (supplied): 724BR, Vented Nickel-Cadmium, 16 ampere hour; 725AR, Sealed Nickel-Cadmium, 2 ampere hour.

Additional (external) Battery Provision: MS3102R14S-2S female connector, with cap, at rear. Mating connector supplied.

Weight: 724BR, net 75 lbs., shipping 101 lbs., including battery; 725AR, net 20 lbs., shipping 36 lbs., including battery.

Dimensions: 724BR, 19" wide, 7" high, 14" deep behind panel, including allowance for cables. 725AR, 19" wide, 3½" high, 12¾" deep behind panel, including allowance for cables.

Accessories Furnished: Power cable, 6 feet long.

Price: 724BR, including battery, \$950.00 (rack mount); 725AR, including battery, \$645.00 (rack mount).

[†]Suitable for operating 113BR, 115BR or 115CR and 103AR or 104AR at any temperature from 0 to 50°C.

Data subject to change without notice.

Hewlett-Packard Standby Power Supplies, Models 724BR and 725AR, improve performance and reliability of frequency and time standard systems by assuring continued operation in the event of ac line power failure. Also, with these standby supplies you can use a standard at various locations, since the system can be kept in operation for extended periods during transport.

Models 724BR and 725AR are completely automatic, solid-state supplies specially designed to power an 113BR or 115BR Frequency Divider and Clock and an 103AR or 104AR Quartz Oscillator¹. These supplies are designed to operate with standby batteries. The standby battery is kept charged and instantly assumes the load, without switching, in case of ac failure. When line power is restored the supply reassumes the load and automatically recharges the battery.

After a week of operation 724BR provides a minimum of 48 hours standby operation at an average temperature of 25°C for an Quartz Oscillator and a 113BR or 115BR Frequency Divider and Clock. Under similar conditions, Model 725AR provides at least six-hour standby operation. A switch at the rear of the 724BR increases standby period at least 50%.

Output is voltage-regulated and current-limited, eliminating the need for output fuses. Operating aids include alarm lamps, contacts for remote alarms and connectors for additional standby batteries.

Both supplies will withstand severe environmental conditions². Model 724BR is equipped with heavy-duty chassis tracks.

¹724AR, required for operation with 113AR Frequency Divider and Clock, available on special order.

²For information regarding the ability of the 724BR and 725AR to meet environmental specifications write to Hewlett-Packard Co., 1501 Page Mill Road, Palo Alto, Calif.

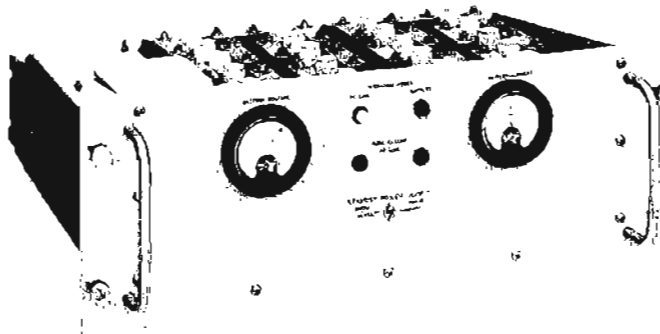

724BR

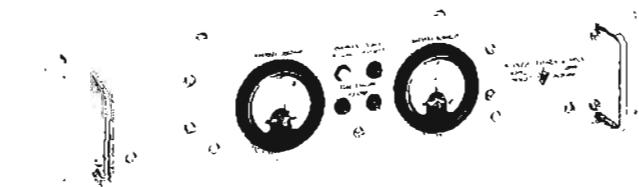

725AR

MICROWAVE INSTRUMENTATION

- *Signal Generators*
- *Modulators*
- *Sweep Oscillators*
- *Power Measurement Instruments*
- *Impedance Measurement Instruments*
- *Noise Figure Measurement Instruments*
- *Waveguide Test Equipment*
- *Coaxial Instrumentation*

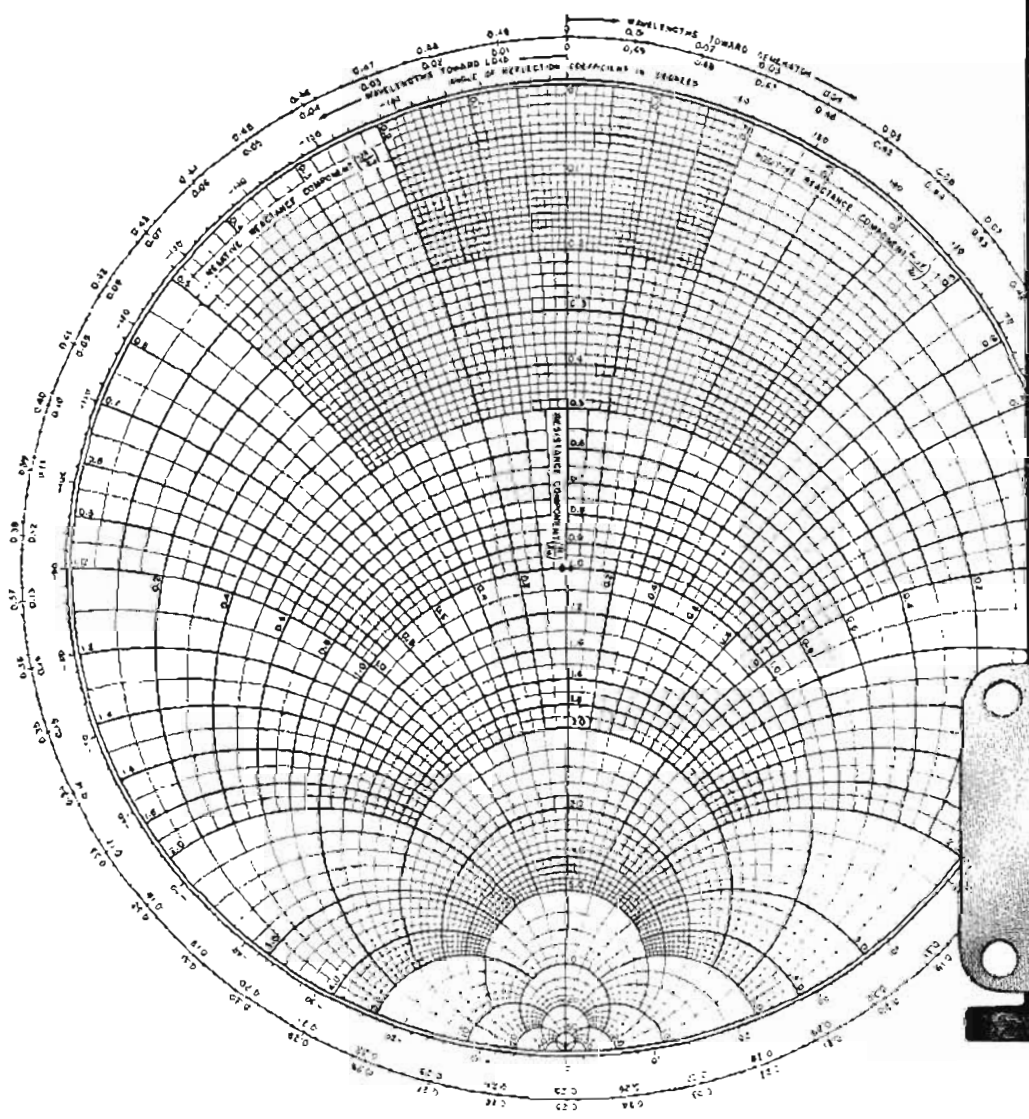

DIRECTIONAL COUPLER
 MODEL X752C 10 38
 2724
HEWLETT-PACKARD
 MADE IN U.S.A.

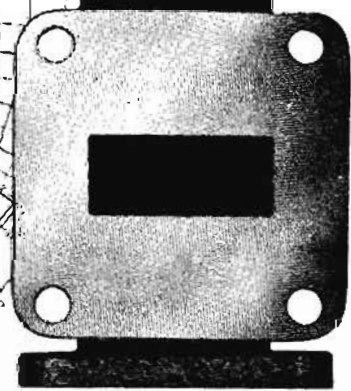

MICROWAVE TEST EQUIPMENT

Hewlett-Packard microwave test equipment includes a wide range of high-quality, low-cost instruments for measurement of microwave parameters. Basic measurements easily made with Hewlett-Packard equipment include power, impedance, noise figure, attenuation and frequency.

Coaxial and waveguide instrumentation provides broadband frequency coverage to 40 gc. Each instrument has been designed to provide simplest possible operation in a broad range of applications. Each unit is thoroughly tested before leaving the factory, and it is warranted to conform with, or exceed, published specifications.

Letter Designations

Model numbers of *hp* waveguide components are normally preceded by a prefix letter, which designates the waveguide size and frequency band of the instrument. Standard waveguide specifications for these bands are shown in the chart below:

indicates specific attenuation or coupling, as follows:

A	3 db	D	20 db
B	6 db	E	30 db
C	10 db	F	40 db

Thus, the 20 db coupling version of *hp* 750 Cross-Guide Coupler will be designated as *hp* 750D. The model of the 750 built for 1" x 1/2" waveguide will, of course, have the prefix "X," so that the complete model number of a 750 Series Coupler with 20 db coupling for use with 1" x 1/2" waveguide is *hp* X750D Cross-Guide Coupler.

Flanges

All Hewlett-Packard waveguide instruments have precision cover flanges which are carefully lapped to assure a flat (or slightly convex) surface. Lapped flanges assure that reflections and leakage will be negligible whenever two Hewlett-Packard waveguide items are joined together.

with circular flanges which may still be in use. Both the cover-to-choke flange adapters and the rectangular to circular flange adapters have lapped flanges to assure negligible reflection when properly installed.

How to Locate Microwave Equipment

Hewlett-Packard equipment for operation in each frequency band is listed in convenient tables on pages 168 through 181. The tables include the most pertinent specifications for each item and, in some cases, reference to other catalog pages where more complete specifications are provided.

Photographs of typical measuring setups accompany the equipment tables. Larger photos of most individual items are included on subsequent pages where instruments are described individually with additional specifications.

Design Objectives

Hewlett-Packard broadband waveguide instruments are the result of a

<i>hp</i>	DESIGNATIONS		DIMENSIONS ID (inches)	TE ₁₀ OPERATING RANGE			FREESPACE WAVELENGTH (cm)	THEORETICAL ATTENUATION db/100 ft. Low to High Freq.	THEORETICAL POWER RATING megawatts Low to High Freq.
	EIA	JAN		Frequency (gc)	Wavelength (cm)	Cutoff Freq. (gc)			
S	WR 284	RG-48/U	2.840 x 1.340	2.60 - 3.95	19.18 - 8.92	2.078	11.53 - 7.59	1.478 - 1.008	2.2 - 3.2
G	WR 187	RG-49/U	1.872 x 0.872	3.95 - 5.85	12.59 - 6.08	3.152	7.59 - 5.12	2.79 - 1.93	0.94 - 1.32
J	WR 137	RG-50/U	1.372 x 0.622	5.30 - 8.20	9.68 - 4.29	4.301	5.66 - 3.66	4.61 - 3.08	0.56 - 0.71
H	WR 112	RG-51/U	1.122 x 0.497	7.05 - 10.0	6.39 - 3.52	5.259	4.25 - 3.00	5.51 - 4.31	0.35 - 0.46
X	WR 90	RG-52/U	0.900 x 0.400	8.20 - 12.4	6.09 - 2.85	6.557	3.66 - 2.42	8.64 - 6.02	0.20 - 0.29
M	WR 75	—	0.750 x 0.375	10.0 - 15.0	4.86 - 2.35	7.868	3.00 - 2.00	10.07 - 7.03	0.17 - 0.23
P	WR 62	RG-91/U	0.622 x 0.311	12.4 - 18.0	3.75 - 1.96	9.487	2.42 - 1.67	12.76 - 11.15	0.12 - 0.16
N	WR 51	—	0.510 x 0.255	15.0 - 22.0	3.11 - 1.60	11.571	2.00 - 1.36	17.3 - 12.6	0.08 - 0.107
K	WR 42	RG-66/U	0.420 x 0.170	18.0 - 26.5	2.66 - 1.33	14.048	1.67 - 1.13	13.3 - 9.5	0.043 - 0.058
R	WR 28	RG-96/U	0.280 x 0.140	26.5 - 40.0	1.87 - 0.88	21.075	1.13 - 0.749	21.9 - 15.0	0.022 - 0.031

Many *hp* instruments also have suffix letters in the complete model number. Normally an "A" suffix identifies the original instrument, while "B," "C" and other suffixes indicate a revised, modified or special version of the basic model. However, in the case of certain *hp* microwave elements, the suffix letter

Model 290A Cover-to-Choke Flange Adapters may be used for connecting Hewlett-Packard instruments and a choke flange system under actual operating conditions. Hewlett-Packard also manufactures adapters for connecting K- and R-band equipment with modern rectangular flanges to older equipment

time- and performance-proven design approach. Fundamental design concepts are:

1. Each instrument is of simplest construction consistent with its basic function and covers the entire frequency range of its waveguide size.

2. An integrated set of instruments is available for each commonly used waveguide frequency from S- to R-band.
3. Simple mechanical design, incorporating novel electrical circuitry, insures highest accuracy, stability and quality and yet makes possible quantity production at low cost.

Calibration and Certification

The Hewlett-Packard Standards Laboratory devotes full time to advancing the art of standards measurements. The techniques used are painstaking and tedious, but the results make these techniques completely worthwhile. Continuing correlation of the Hewlett-Packard house standards with the available certification services of the National Bureau of Standards assures that high accuracy is built into all *hp* microwave equipment. Traceability to the national standards, wherever the certification service is available, can be supplied for the applicable *hp* microwave instruments.

One of the services available from the Hewlett-Packard standards laboratory is calibration of *hp* waveguide equipment at specific frequencies to higher accuracy than specified on a broadband basis in this catalog. Information on availability of this service and on the charges for it is available through your local *hp* field engineer.

Microwave Measuring Techniques

There are two basic types of microwave measuring techniques—(1) fixed frequency and (2) swept frequency.

One typical example of a fixed frequency system is a slotted section which is used to make *swr* measurements, one frequency at a time. Fixed frequency measuring systems of this nature are perfectly satisfactory if one is operating at a single frequency or within a very narrow band. To meet requirements for fixed frequency measurements, Hewlett-Packard builds a complete line of both coaxial and waveguide slotted sections and tuners.

Fixed frequency techniques are widely used in "standards" laboratories—ranging from those of the National Bureau of Standards to smaller installations maintained by individual contractors. Most standards measurements are made at discrete frequencies.

Swept frequency techniques are used to obtain measurements quickly and easily for a range of frequencies. In this type of system, typified by the swept frequency reflectometer, a frequency source is swept through the band over which measurements are desired. Signals propagating to the unknown are separated by directional couplers into incident and reflected components. These can then be equated to *swr*, reflection coefficient or other similar terms.

Although, as explained below, swept frequency techniques have been refined to a high degree of accuracy, fixed frequency methods continue to offer the highest precision attainable for individual measurements. In a fixed frequency system the small inherent mismatch ambiguities, which must be tolerated in a broadband, swept frequency system, may be individually tuned out.

Attenuation Measurement

Attenuation measurements are made by a number of different methods such as power ratio or either *rf* or *IF* substitution.

In the power ratio method the signal source is connected to a detector mount through a length of lossless transmission system—in whose place the unknown attenuator may be substituted. A reading is obtained on the output indicator with a section of lossless line in the circuit. The lossless line is then replaced by the attenuator being measured. The power reduction at the output indicator is a measure of the attenuation. This measurement requires, first, that the law of the detector is known over the complete frequency range of the measurement, and, second, that reflection effects in the system are essentially the same both with and without the attenuator.

The type of detecting equipment used will depend on the range of the attenuation measurement. A range of attenuation measurement up to 20 or 30 db can be achieved with a detector mount employing a barretter and an *hp* 415 series standing wave indicator (high sensitivity, tuned voltmeter). In this case, the signal source must be modulated, and the *rf* power level must be kept below 200 microwatts for square law detector characteristics. The 415D, with its 2.5 db steps and 0.02 db tracking accuracy, is especially useful for these measurements.

To eliminate effects of reflections between generator and attenuator, and attenuator and load, it is desirable to use pads. Pads should be well matched to the transmission system.

The homodyne method permits measuring attenuation as high as 100 db. In this system a signal generator furnishes local oscillator power to a mixer and at the same time drives a TWT amplifier which is modulated to produce an offset frequency. The offset frequency is fed through the attenuator to be measured and combined with the local oscillator frequency in the mixer. The difference frequency is amplified in a tuned amplifier and applied to an indicating meter. Because the TWT amplifier is ferrodyne modulated, the difference frequency from the mixer is constant and a narrow-band tuned amplifier such as the *hp* 415 may be used even though the signal generator frequency drifts.

RF substitution depends on substituting an attenuator of known characteristic for the unknown. For instance, a signal generator attenuator may be used. When using this method the output of the signal generator is fed to the attenuator being measured and then into the detector. The attenuator being measured is removed, and a reading is obtained upon the detector. The setting of the signal generator attenuator is noted. The attenuator is then inserted, and the signal generator output is adjusted to obtain the same reading as before. The difference between the sig-

nal generator attenuator settings is the attenuation of the unknown in db. Since the detector is always operated at the same level, detector law is no problem. The attenuator measurement may be performed in a similar manner with *hp* 382 Series Precision Attenuator and a signal source.

The IF substitution method offers the widest dynamic range in attenuation measurements since a linear detector is used. The power change caused by removing the unknown rf attenuator is replaced by change of the precision IF cutoff attenuator in the IF stage of the detecting microwave receiver.

Power, Impedance, Noise Figure Measurements

General information and techniques for making power measurements with Hewlett-Packard microwave test equipment are presented on pages 194 and 195. A similar discussion concerning microwave impedance measurements appears on page 231. A discussion on noise figure measurements appears on page 182.

Swept Frequency Techniques

In using microwave test equipment, an engineer relies heavily on the manufacturer's specifications to assure performance of his test system. He cannot afford tedious and complex pre-testing before using the microwave equipment.

Hewlett-Packard has always been keenly aware of its responsibility to the user of its microwave test equipment. Hewlett-Packard operating philosophy calls for the best design consistent with state-of-the-art microwave concepts, plus production processes to provide the finest quality microwave test equipment at nominal expense. Even more important than design and production is the test method used to assure that the equipment performs equal to or better

than published specifications. In the test process used at *hp*, known as full-range testing, each item is tested at all points within its frequency band, usually with a sweep oscillator. To provide full-range testing on a production basis Hewlett-Packard pioneered the reflectometer concept of swept frequency reflection testing. Not only have these techniques led to more comprehensive testing of Hewlett-Packard's own instruments, but they also have offered speed and accuracy to microwave measuring applications throughout the world. Full-range testing techniques are now widely known and widely accepted.

As new equipment is developed, Hewlett-Packard engineers refine and improve the techniques of full-range testing and apply them to even more measurement problems. To a unique degree *hp* has been able to do this in its own waveguide test department. The speed of testing and the comprehensive results obtained more than offset the slight increase in cost of a given test setup.

Systems for Full-Range Testing

Early reflectometers were subject to a variety of calibration errors. Initial calibration is generally performed with a 100 per cent reflection, such as a sliding short. Subsequent tests on a low-reflection unknown may cause error by placing the reverse detector in a much lower power region. Other scalar errors must also be considered.

An improved reflectometer system which materially reduces calibration errors has been developed at Hewlett-Packard. This arrangement (see Figure 1) enables continuous calibration over the entire frequency range by means of a broadband rotary vane attenuator in the secondary arm of the reverse coupler.

The attenuator, in effect, pre-inserts the return losses anticipated for actual tests. With the attenuator in the system, a frequency sweep of the reference short yields calibration traces that include most system errors. A series of such traces can then be compared with the performance trace of the instrument being tested on a go/no-go basis.

Scalar errors caused by nonmatch of the coupling factors, variation of detectors with frequency and power, and errors in the ratiometer and x-y recorder can be disregarded because of their inclusion in the calibration curves. Overall accuracy of the system is still limited by the reverse coupler directivity vector—a short-coming of any high-directivity reflectometer system.

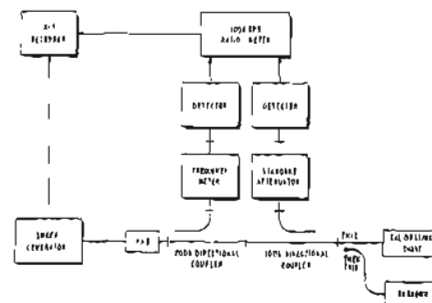

Figure 1. Improved setup for sweep frequency swr measurements.

This improved technique can be modified for a wide variety of basic measurements and has been adopted for production test of most Hewlett-Packard microwave instruments. SWR, directivity, attenuation, crystal matching, and TWT noise figure measurements are easily performed.

Step-by-Step Procedure for Measuring SWR

Connect the 100 per cent calibrating short to the reverse coupler, see Figure 1.

Set the expected value of return loss into the standard rotary vane attenuator. For instance, if the expected swr is 1.2, the standard attenuator should be set to 20.8 db. (Return loss = $20 \text{ Log } \rho = 20 \text{ Log } [\text{swr} - 1/\text{swr} + 1]$.)

Set the ratiometer range and the x-y recorder sensitivity to keep the pen on scale.

Sweep the frequency generator over the required range to obtain a calibration plot of frequency vs. swr.

Reset the attenuator to simulate other swr values and plot additional calibration lines. A series of typical calibration lines is shown in Figure 2. Two calibration lines give enough information for go/no-go tests.

Replace the calibrating short with the unknown load.

Return the standard attenuator to zero db and trigger the final measurement sweep. The colored trace in Figure 2 shows an instrument swr characteristic between 8.2 and 12.4 gc.

Where repeated tests of identical instruments are to be performed, the calibrating traces can be inscribed on transparent paper to compare with measurement traces.

A setup for swept frequency attenu-

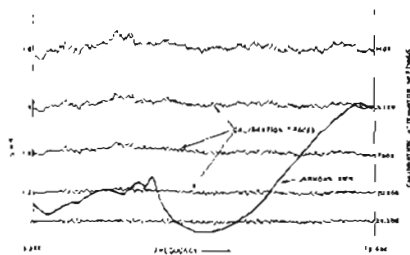

Figure 2. Typical swr plot.

ation measurements is illustrated in Figure 3. Here, the reflected channel of the ratiometer becomes the transmission channel because the coupler-detector is placed in the forward direction. The transmission detector should be isolated by a coupler or pad to provide good matching over the entire test band.

Calibration traces are plotted with the precision attenuator set near the expected values of attenuation. The unknown is inserted in the line, and the standard attenuator returned to zero db. The final test sweep is then run with the unknown attenuator. Characteristics of a flap attenuator set to 15 db are shown in Figure 4.

The measurements described here can also be made with coaxial systems. Broadband coaxial pads of various values provide the standard rf attenuation when calibrating the equipment.

Measurements in coaxial systems would, however, be less accurate than those in waveguides because random directivity errors are somewhat larger in coaxial couplers.

Measurement Errors

The errors inherent in broadband

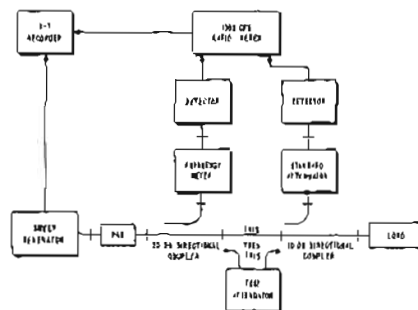

Figure 3. Setup for accurate sweep frequency attenuation measurements.

measuring procedures are divided into vector errors and scalar errors. Vector errors are primarily due to imperfect directivity of the reverse couplers. Typical multi-hole precision couplers with directivities greater than 40 db give reflection coefficient errors of 0.01 or less in the final reading.

A second vector error is due to variation in the matching of the standard attenuator in the calibration and measurement steps of the test procedure. This causes slight variations of transmitted power in going from the "Calibrate" to "Measure" condition. If the attenuator has an swr of 1.15, the ambiguous mismatch error is less than 0.4 db (equivalent to a 5 per cent error of the reflection coefficient value).

Inaccuracy of the standard attenuator is the major contribution to scalar error. Hewlett-Packard rotary vane attenuators have specified accuracies of 2 per cent of the reading. For a return loss measurement of - 20 db, such attenuator inaccuracies would result in a 5 per cent error of reflection coefficient value. Such errors can be minimized through point-by-point calibration of the standard attenuator. All other scalar variations are calibrated out by the test procedure.

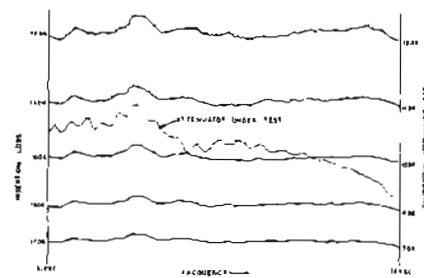
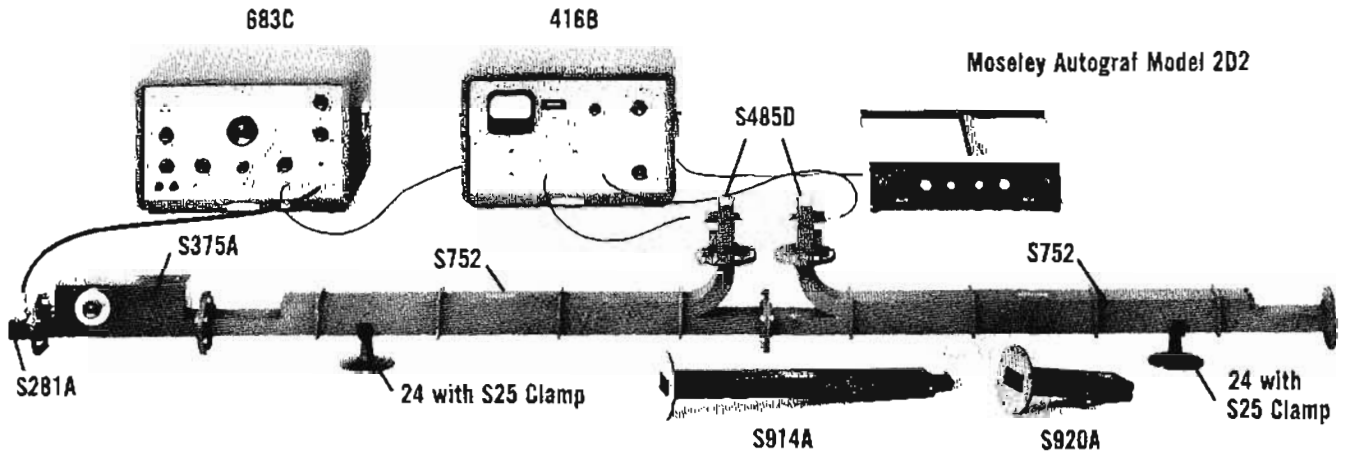

Figure 4. Attenuation characteristics of a flap attenuator.

Model	Description	Accuracy	Range	SWR (max.)	Power (watts)	Length (Inches)	Page Reference	Price
S281A	Adapter, waveguide-to-coax			1.25		3	179	\$50
S290A	Adapter, cover-to-choke flange					3	179	\$65
S347A	Noise Source, waveguide	± 0.5 db	16.2 db	1.2		22½	185	\$360
S370	Attenuators, fixed	± 20%	3, 6, 10, 20 db	1.15	1	12	187	\$100
S372	Attenuators, precision fixed	± 0.5 db	10, 20 db	1.05	2	46	187	\$425
S375A	Attenuator, flap	± 1 db at <10 db ± 2 db at >10 db	0 to 20 db	1.15	2	14⅞	187	\$165
S380A	Attenuator, waveguide	± 0.3 db at 3 gc	0 to 10 db	1.15	1	10		\$260
S382B	Attenuator, precision variable	± 1% or 0.1 db to 50 db; ± 2% above 50 db	0 to 60 db	1.15	10	25¼	188	\$600
S382C	Same as S382B except for degrees-of-rotation dial calibrated in 100'ths, as opposed to 10'ths on the S382B.						188	\$650
S485A	Detector Mount (less detector)			1.35		4-11/16	191	\$185
S485D	Detector Mount (with barretter)	Response: ± 1 db Sq. Law: <± 0.5 db	Sensitivity 0.2 v/mw	1.5	1	4½	193	\$200
S486A	Thermistor Mount, compensated		0.001 to 10 mw	1.35		3	199	\$195
S487B	Thermistor Mount, broadband		0.01 to 10 mw	1.35		2¾	196	\$105
S750	Directional Couplers, cross-guide	± 1.7 db	20, 30 db			9 x 9	232-233	\$150
S752	Directional Couplers, multi-hole	Mean: ± 0.4 db Variation: ± 0.5 db	3, 10, 20 db	1.1 1.05 1.05		50¼ 48 48	232-233	\$400
S810A (444A)	Slotted-Section, waveguide, and carriage (Detector Probe for S810A)			1.01		12¾	236-237	\$450 (\$55)
S870A	Tuner, slide screw	Insertion Loss: <2 db at 20:1 swr	Corrects swr of 20			11	239	\$250
S910A	Termination, low power			1.04		10¼	241	\$75
S912A	Termination, high power			1.1	100	15¼	241	\$200
S914A	Moving Load	Load Reflection: <0.5%	>½ wavelength	1.01	2	25¾	241	\$125
S920A	Adjustable Short		>½ wavelength			10-7/16	241	\$150
S25	Waveguide Clamp						179	\$2.50
24	Waveguide Stand						179	\$3
S36A	Frequency Meter (Coaxial)	± 0.17%, 1 to 4.2 gc ± 0.22%, 0.9 to 1 gc		1.2		6	204	\$500

Data subject to change without notice.

Instrument	Frequency Range	Characteristics	Price
616B Signal Generator	1.8 to 4.2 gc	Output 0.1 μv to 0.233 v into 50 ohm load; pulse, cw or FM; direct calibration	\$1950 \$1970 (R)
8616A Signal Generator	1.8 to 4.5 gc	Output 0.1 μv to 0.707 v into 50-ohm load; cw, pulse, FM or AM; leveled output and direct calibration	\$1650
683C Sweep Oscillator	2 to 4 gc	Electronically swept; variable sweep rate, width; output 30 mw. swr 2.5 or less; pulse, square wave, FM, AM; leveled output	\$3000 \$2985 (R)
8716A Modulator	1.8 to 4.5 gc	Amplitude modulation of any signal up to 1 watt; pulse modulation with 20 nsec of rise time; level klystron oscillators	\$850
490B Microwave Amplifier	2 to 4 gc	30 db gain; AM, helix input; 10 mw output	\$1500
491C Microwave Amplifier	2 to 4 gc	30 db gain; AM input; 1 watt output	\$2300



Above is a swept frequency reflectometer for measuring discontinuities in S-band systems. In this frequency range barretters are used for detectors. Since they have excellent square law response, no calibrating attenuator is used. The x-y recorder provides a permanent plot of reflection coefficient versus frequency.

Below is a fixed frequency setup to calibrate an S382B Precision Rotary Attenuator. The *bp* 415D on the right is used to measure the attenuation introduced by the S382B. The second 415D, connected to the slotted line, measures the *swr* of the attenuator. It is also used to tune the barretter mount to unity before inserting the S382B. A one-watt source is required to calibrate the attenuator at maximum attenuation (60 db). This power is furnished by an *bp* 8616A Signal Generator and an *bp* 491C Microwave Amplifier.

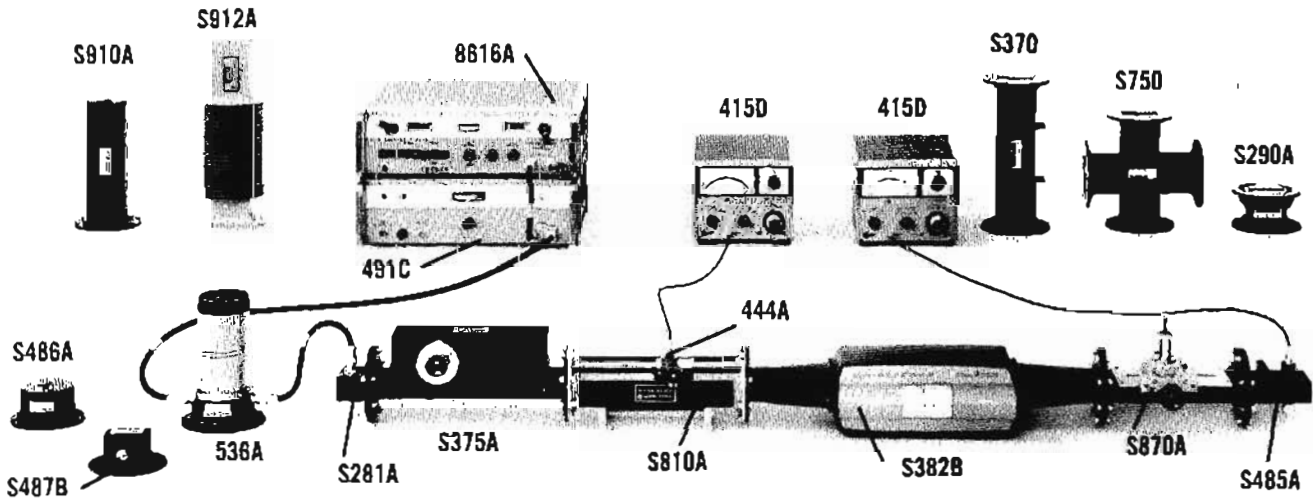

G 3.95 GC
to
5.85 GC

Model	Description	Accuracy	Range	SWR (max.)	Power (watts)	Length (inches)	Page Reference	Price
G281A	Adapter, waveguide-to-coax			1.25		2 1/8	179	\$40
G290A	Adapter, cover-to-choka flange					2	179	\$55
G347A	Noise Source, waveguide	±0.5 db	15.2 db	1.2		19	185	\$285
G370	Attenuators, fixed	±20%	3, 6, 10, 20 db	1.15	1	10 1/4	187	\$95
G372	Attenuators, precision fixed	±0.5 db	10, 20 db	1.05	2	30	187	\$300
G375A	Attenuator, flap	±1 db at <10 db ±2 db at >10 db	0 to 20 db	1.15	2	13	187	\$145
G382A	Attenuator, precision variable	±2% of reading, or 0.1 db whichever ever is greater	0 to 50 db	1.15	15	31 1/2	188	\$500
G485B	Detector Mount (less detector)			with barretter 1.25		9-5/16	191	\$100
G485D	Detector Mount (with barretter)	Response: ±1 db Sq. Law: <±0.5 db	Sensitivity: 0.2 v/mw	1.5		3 1/8	193	\$170
G486A	Thermistor Mount, compensated		0.001 to 10 mw	1.5		4	199	\$180
G487B	Thermistor Mount, broadband		0.01 to 10 mw	1.5		2 1/8	196	\$95
G532A	Freq. Meter, direct reading	± 0.033% at 23°C ± 0.065% overall				6 1/4	204	\$375
G750	Directional Couplers, cross-guide	±1.7 db	20, 30 db			6 x 6	232-233	\$120
G752	Directional Couplers, multi-hole	Mean: ±0.4 db Variation: ±0.5 db	3, 10, 20 db	1.1 1.05 1.05	2	34 3/8 33 33	232-233	\$300
G810B (809B) (444A)	Slotted Section, waveguide (Carriage for 810B) (Detector Probe for 809B)			1.01		10 1/4	236-237	\$125 (\$175) (\$55)
G870A	Tuner, slide screw	Insertion Loss: <2 db at 20:1 swr	Corrects swr of 20			8 1/4	239	\$200
G910A	Termination, low power			1.04	2	6 1/2	241	\$65
G914A	Moving Load	Load Reflection: <0.5%	> 1/2 wavelength	1.01	2	17	241	\$95
G920A	Adjustable Short		> 1/2 wavelength			7-13/16	241	\$125
G25	Waveguide Clamp						179	\$2.50
24	Waveguide Stand						179	\$3

Instrument	Frequency Range	Characteristics	Price
618B Signal Generator	3.8 to 7.6 gc	Output 0.1 μv to 0.223 v into 50 ohm load; cw, pulse, FM or square wave modulation; direct calibration	\$2250 \$2270 (R)
620A Signal Generator	7 to 11 gc	Same as 618B	\$2250 \$2270 (R)
684C Sweep Oscillator	4 to 8 gc	Electronically swept; variable sweep rate and width; output 10 mw, swr 2.5 or less; pulse, square wave, FM, AM; leveled output	\$2900 \$2885 (R)
492A Microwave Amplifier	4 to 8 gc	30 db gain; AM, helix input; 20 mw output	\$2000
493A Microwave Amplifier	4 to 8 gc	30 db gain; AM; 1 watt output	\$2900

This is a typical fixed frequency setup in G-band. The G870A is used to tune the thermistor mount for unity swr, resulting in more accurate power measurements. The rack mounting versions of the bp 618B, 415B and 430C are shown.

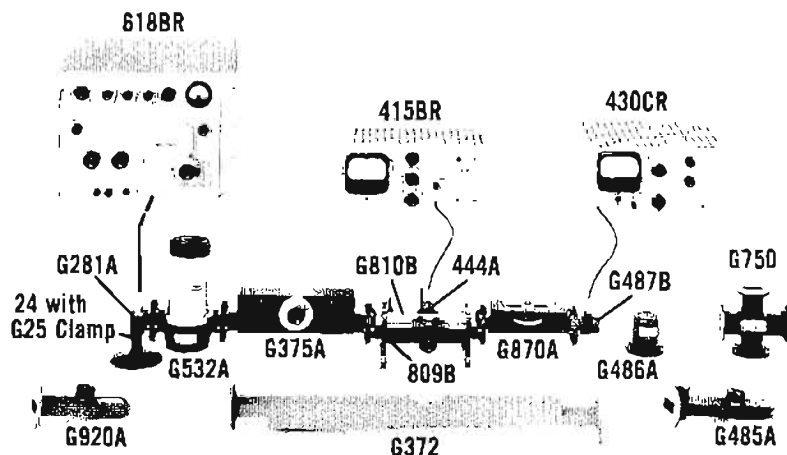

3.95 to 8.20 GC

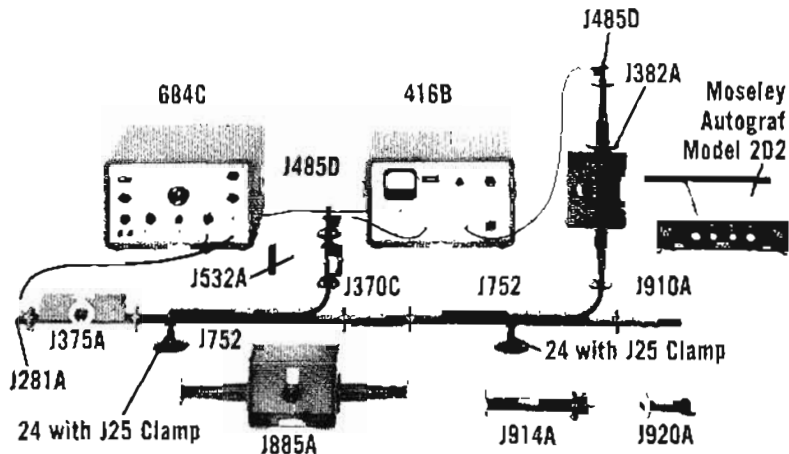

This is a swept frequency system to measure attenuation. Here a J370C is being checked to see that it meets its accuracy specification across the frequency range 5.3 to 8.2 gc. The x-y recorder plots insertion loss in db on the y-axis versus frequency on the x-axis. The J382A attenuator is used to calibrate the system with the unknown attenuator removed. This method of calibration accounts for the transmission characteristics of the system over the frequency range of interest. Application Note No. 54, available on request, gives complete information on this and other improved swept frequency techniques.

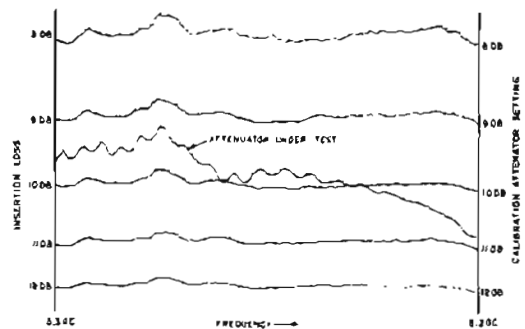

J 5.3 GC to 8.20 GC

This is a typical x-y plot obtained from the setup shown in the photograph.

Model	Description	Accuracy	Range	SWR (max.)	Power (watts)	Length (inches)	Page Reference	Price
J281A	Adapter, waveguide-to-coax			1.25 (1.3 from 5.3 to 5.5 gc)		2	179	\$35
J290A	Adapter, cover-to-choke flange					1 3/4	179	\$40
J347A	Noise Source, waveguide	± 0.5 db	15.2 db	1.2		19	185	\$265
J370	Attenuators, fixed	± 20%	3, 6, 10, 20 db	1.15	1	8 1/4	187	\$85
J372	Attenuators, precision fixed	± 0.5 db (5.85 to 8.2 gc)	10, 20 db	1.05	1	22 3/4	187	\$190
J375A	Attenuator, flap	± 1 db at < 10 db ± 2 db at > 10 db	0 to 20 db	1.15	2	13	187	\$135
J382A	Attenuator, precision variable	± 2% of reading or 0.1 db whichever is greater	0 to 50 db	1.15	10	25 1/8	188	\$375
J485B	Detector Mount (less detector)			with barretter 1.5		7 3/8	191	\$95
J485D	Detector Mount (with barretter)	Response: ± 1 db Sq. Law: < ± 0.5 db	Sensitivity: 0.2 v/mw	1.5		4 1/4	193	\$170
J486A	Thermistor Mount, compensated		0.001 to 10 mw	1.5		3 3/8	199	\$170
J487B	Thermistor Mount, broadband		0.01 to 10 mw	1.5		1 3/4	196	\$90
J532A	Frequency Meter, direct reading	± 0.033% at 23°C ± 0.065% overall				6 1/4	204	\$350
J750	Directional Couplers, cross-guide	± 1.7 db	20, 30 db			5 x 5	232-233	\$100
J752	Directional Couplers, multi-hole	Mean: ± 0.4 db Variation: ± 0.5 db (5.85 to 8.2 gc)	3, 10, 20 db	1.1, 1.05, 1.05	1	26 1/2, 25-9/16, 25-9/16	232-233	\$190
J810B (809B) (444A)	Slotted Section, waveguide (Carriage for 810B) (Detector Probe for 809B)			1.01		10 1/4	236-237	\$110 (\$175) (\$55)
J870A	Tuner, slide screw	Insertion Loss: < 2 db at 20:1 swr	Correct swr of 20			7 3/8	239	\$165
J885A	Waveguide Phase Shifter	Lesser of 3° or 10%	-360° to +360°	1.35	10	75	240	\$550
J910A	Termination, low power			1.02	1	8-3/16	241	\$55
J914A	Moving Load	Load Reflection: < 0.5%	> 1/2 wavelength	1.01	2	13 1/2	241	\$85
J920A	Adjustable Short		> 1/2 wavelength			6 1/4	241	\$100
J25	Waveguide Clamp						179	\$2.50
24	Waveguide Stand						179	\$3

Data subject to change without notice.

H, X-BAND

Miscellaneous *hp* H Band equipment is shown with a typical H Band and fixed frequency measuring system.

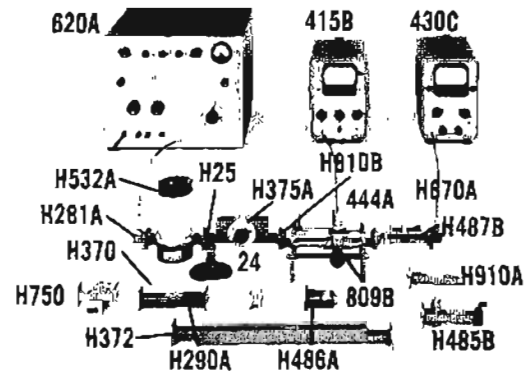

Model	Description	Accuracy	Range	SWR (max.)	Power (watts)	Length (inches)	Page Reference	Price
H281A	Adapter, waveguide-to-coax			1.25		1 1/2	179	\$30
H290A	Adapter, cover-to-choke flange					1 1/2	179	\$35
H347A	Noise Source, waveguide	±0.5 db	15.2 db	1.2		16	185	\$250
H370	Attenuators, fixed	±20%	3, 6, 10, 20 db	1.15	1	6 3/4	187	\$75
H372	Attenuators, precision fixed	±0.5 db	10, 20 db	1.05	1	20 7/8	187	\$135
H376A	Attenuator, flap	±1 db at < 10 db ±2 db at > 10 db	0 to 20 db	1.15	2	8 1/4	187	\$125
H382A	Attenuator, precision variable	±2% of reading, or 0.1 db, whichever is greater	0 to 50 db	1.15	10	19-15/16	188	\$350
H421A	Detector Mount (with crystal)	Freq. Resp.: ±2 db Sens.: approx. 0.05 v dc/mw cw		1.6			193	\$95 \$210 (matched pair)
H485B	Detector Mount (less detector)			with barrier 1.25		6 3/4	191	\$85
H486A	Thermistor Mount, compensated		0.001 to 10 mw	1.5		3 3/8	199	\$165
H487B	Thermistor Mount, broadband		0.01 to 10 mw	1.5		1-5/16	196	\$80
H532A	Frequency Meter, direct reading	±0.040% at 23°C ±0.075% overall				6 1/4	204	\$300
H750	Directional Couplers, cross-guide	±1.7 db	20, 30 db			4 x 4	232-233	\$75
H752	Directional Couplers, multi-hole	Mean: ±0.4 db Variation: ±0.5 db	3, 10, 20 db	1.1 1.05 1.05	1	18 1/4 17 1/2 17 1/2	232-233	\$135
H810B (809B) (444A)	Slotted Sections, waveguide (Carriage for 810B) (Detector Probe for 809B)			1.01		10 1/4	236-237	\$110 (\$175) (\$35)
H670A	Tuner, slide screw	Insertion Loss: < 2 db at 20:1 swr	Corrects swr of 20			6	239	\$140
H910A	Termination, low power			1.02	1	6 3/4	241	\$45
H914A	Moving Load	Load Reflection: < 0.5%	> 1/2 wavelength	1.01	1	11 1/4	241	\$70
H920A	Adjustable Short		> 1/2 wavelength			4 7/8	241	\$85
H25	Waveguide Clamp						179	\$2.50
24	Waveguide Stand						179	\$3

Data subject to change without notice.

Instrument	Frequency Range	Characteristics	Price
620A Signal Generator	7 to 11 gc	Output 0.1 μv to 0.223 v into 50 ohm load; cw, pulse, FM or square wave modulation; direct calibration	\$2250 \$2270 (R)
626A Signal Generator	10 to 15.5 gc	Output + 10 dbm to - 90 dbm; cw, pulse, FM or square wave modulation; direct calibration	\$3400 \$3420 (R)
H01 686C Sweep Oscillator	7 to 11 gc	Electronically swept; variable sweep rate and width; output 10 mw, swr 2 or less; pulse, square wave, FM, AM; leveled output	\$3000 \$2985 (R)
494A Microwave Amplifier	7 to 12.4 gc	30 db gain; AM, helix input; 20 mw output	\$2000
495A Microwave Amplifier	7 to 12.4 gc	30 db gain; AM; 1 watt output	\$2900

7.05 to 12.4 GC

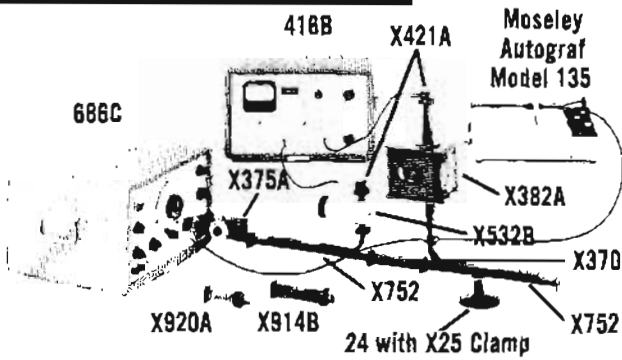

This reflectometer system consists of Hewlett-Packard X-band instruments. The set-up will measure either the swr of an unknown load or the directivity of the coupler on the right. The X532B Absorption Wave Meter provides frequency markers on the x-y record. The X382A Precision Variable Attenuator, as in previous reflectometer examples, calibrates the x-y trace in terms of the parameter to be measured.



Model	Description	Accuracy	Range	SWR (max.)	Power (watts)	Length (inches)	Page Reference	Price
X281A	Adaptor, waveguide-to-coax			1.25		1/2	179	\$25
X290A	Adaptor, cover-to-choke flange					1/2	179	\$20
X347A	Noise Source, waveguide	±0.5 db	15.2 db	1.2		14 1/4	185	\$200
X362	Low Pass Filter	Insertion Loss, Passband: <1 db Stopband: >40 db	Passband: 8.2 to 12.4 gc Stopband: 16 to 37.5 gc	Passband 1.5		5-11/32	186	\$325
X370A	Attenuators, fixed	±20%	3, 6, 10, 20 db	1.15	1	5 1/4	187	\$65
X372	Attenuators, precision fixed	±0.5 db	10, 20 db	1.05	1	19 1/8	187	\$110
X375A	Attenuator, flap	±1 db at <10 db ±2 db at >10 db	0 to 20 db	1.15	2	7-3/16	187	\$100
X382A	Attenuator, precision variable	±2% of reading or 0.1 db, whichever is greater	0 to 50 db	1.15	10	16 5/8	188	\$275
X421A	Detector Mount (with crystal)	Freq. Resp.: ±2 db Sens.: 0.05 v dc/mw cw		1.5			193	\$75 \$170 (matched pair)
X485B	Detector Mount (less detector)			with barretter 1.25		6	191	\$75
X486A	Thermistor Mount, compensated		0.001 to 10 mw	1.5		2 1/8	199	\$145
X487B	Thermistor Mount, broadband		0.01 to 10 mw	1.5		1-3/16	196	\$75
X532B	Frequency Meter, direct reading	±0.05% at 23°C ±0.08% overall				4 1/2	204	\$200
X750	Directional Couplers, cross-guide	±1.7 db	20, 30 db			3 x 3	232-233	\$60
X752	Directional Couplers, multi-hole	Mean: ±0.4 db Variation: ±0.5 db	3, 10, 20 db	1.1 1.05 1.05	1	16-11/16 15-11/16 15-11/16	232-233	\$110
X810B (809B) (444A)	Slotted Section, waveguide (Carriage for 810B) (Detector Probe for 809B)			1.01		10 1/4	236-237	\$90 (\$175) (\$55)
X870A	Tuner, slide screw	Insertion Loss: <2 db at 20:1 swr	Corrects swr of 20			5 1/2	239	\$130
X880A	E-H Tuner	Insertion Loss: 3 db at 20:1 swr	Corrects swr of 20			3 1/2	239	\$130
X885A	Waveguide Phase Shifter	<2° at 8.2 to 10 gc or 10% <3° at 10 to 12.4 gc or 10%	-360° to +360°	1.35		15 1/8	240	\$425
X910B	Termination, low power			1.02	1	6 3/8	241	\$35
X913A	Termination, high power			1.05	500	9 1/2	241	\$100
X914B	Moving Load	Load Reflection: <0.5%	>1/2 wavelength	1.01	1	10	241	\$60
X916B	Standard Reflection	Coefficient: ±0.0025	Nom. Reflect. Coeff.: 0.05			10 1/4	241	\$125
X916C	Standard Reflection	Coefficient: ±0.0035	Nom. Reflect. Coeff.: 0.1			10 1/4	241	\$125
X916D	Standard Reflection	Coefficient: ±0.0045	Nom. Reflect. Coeff.: 0.15			10 1/4	241	\$125
X916E	Standard Reflection	Coefficient: ±0.007	Nom. Reflect. Coeff.: 0.2			10 1/4	241	\$125
X920A	Adjustable Short		>1/2 wavelength			4 3/8	241	\$75
X930A	Waveguide Shorting Switch	Insertion Loss "Open": <0.05 db		Open: 1.02 "Shorted": >125		3-11/16	241	\$160
X25	Waveguide Clamp						179	\$2.50
24	Waveguide Stand						179	\$3

Model	Description	Accuracy	Range	SWR (max.)	Power (watts)	Length (inches)	Page Reference	Price
P290A	Adapter, cover-to-choke flange					1 1/8	179	\$30
NP292A	Adapter, waveguide-to-waveguide		15 to 18 gc	1.05		2 3/4	179	\$40
P347A	Noise Source, waveguide	±0.5 db	15.2 dB			14 3/4	185	\$250
P362A	Low Pass Filter	Insertion Loss, Passband: <1 db Stopband: >40 db	Pass: 12.4 to 18 gc Stop: 23 to 54 gc	Passband 1.5		3-11/16	186	\$350
P370	Attenuators, fixed	±20%	3, 6, 10, 20 db	1.15	1	4 1/2	187	\$80
P372	Attenuators, precision fixed	±0.5 db	10, 20 db	1.05	1		187	\$125
P375A	Attenuator, flap	±1 db at <10 db ±2 db at >10 db	0 to 20 db	1.15	1	7 1/4	187	\$135
P382A	Attenuator, precision variable	±2% of reading or 0.1 db whichever is greater	0 to 50 db	1.15	5	12 1/2	188	\$300
P421A	Detector Mount (with crystal)	Freq. Resp.: ± 2 db Sens.: 0.05 v dc/mw cw		1.5			193	\$150 \$320 (matched pair)
P486A	Thermistor Mount, compensated		0.001 to 10 mw	1.5		2 1/2	199	\$195
P487B	Thermistor Mount, broadband		0.01 to 10 mw	1.5		13/16	196	\$110
P532A	Frequency Meter, direct reading	±0.068% at 23°C ±0.1% overall				4 1/2	204	\$275
P752	Directional Couplers, multi-hole	Mean: ±0.4 db Variation: ±0.5 db	3, 10, 20 db	1.1 1.05 1.05	1	13 3/4 12 1/4 12 1/4	232-233	\$125
P810B (8098) (444A)	Slotted Section, waveguide (Carriage for 810B) (Detector Probe for 8098)			1.01		10 1/4	236-237	\$110 \$175 (\$55)
P870A	Tuner, slide screw	Insertion Loss: <2 db at 20:1 swr	Corrects swr of 20			5	239	\$140
P880B	E-H Tuner	Insertion Loss: 3 db at 20:1 swr	Corrects swr of 20			2 1/4	239	\$150
P885A	Waveguide Phase Shifter	Lesser of 4° or 10%	-360° to +360°	1.35	5	12 1/8	240	\$600
P910A	Termination, low power			1.02	1	4 1/2	241	\$40
P914A	Moving Load	Load Reflection: <0.5%	> 1/2 wavelength	1.02	0.5	9 3/4	241	\$70
P920B	Adjustable Short		> 1/2 wavelength			5 3/4	241	\$125
P932A	Harmonic Mixer				0.1		143	\$250
P95	Waveguide Clamp						179	\$2.50
24	Waveguide Stand						179	\$3

Data subject to change without notice.

Instrument	Frequency Range	Characteristics	Price
626A Signal Generator	10 to 15.5 gc	Output + 10 dbm to - 90 dbm; pulse, FM or square wave modulation; direct calibration	\$3400 \$3420 (R)
628A Signal Generator	15 to 21 gc	Same as 626A	\$3400 \$3420 (R)
687C Sweep Oscillator	12.4 to 18 gc	Electronically swept; variable sweep range and rate; leveled output ± 1.5 db; 10 mw output	\$3400 \$3385 (R)
716A Klystron Power Supply		Beam voltage, 250 to 800 v dc @ 100 ma; repeller voltage, 0 to 800 v, clamped modulator, regulated dc filament supply	\$775

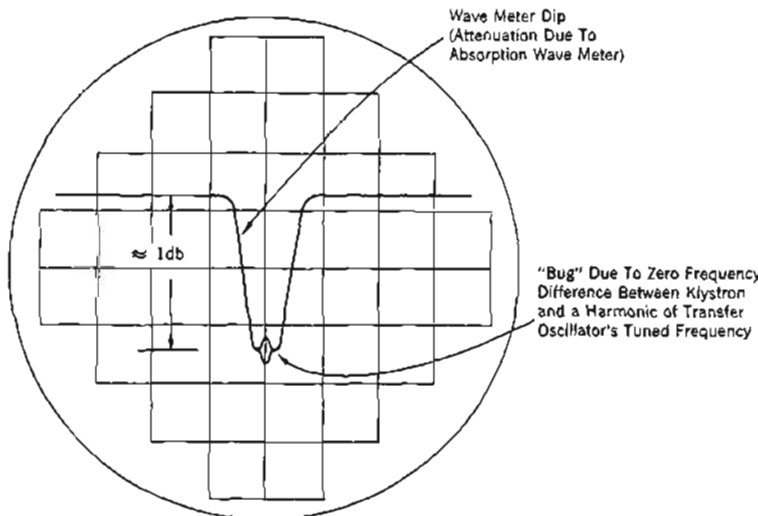

12.4 to 18.0 GC

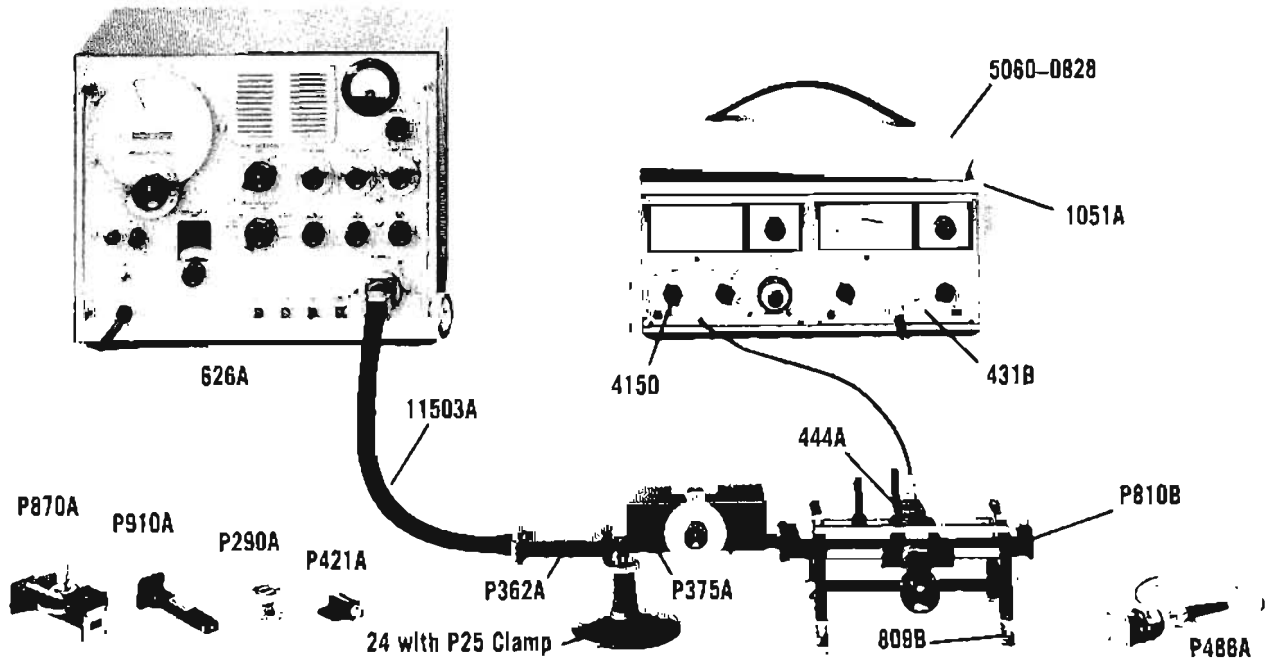

This is a typical fixed frequency setup in P-band. Note the portable microwave lab composed of an *hp* 431B Power Meter and an *hp* 415D SWR Meter installed in the *hp* 1051A Combining Case (see pages 18 and 19). Both of the instruments may be purchased with optional rechargeable batteries and then used independent of the ac line. They are useful for measurements around missiles, aircraft, antenna towers, etc.

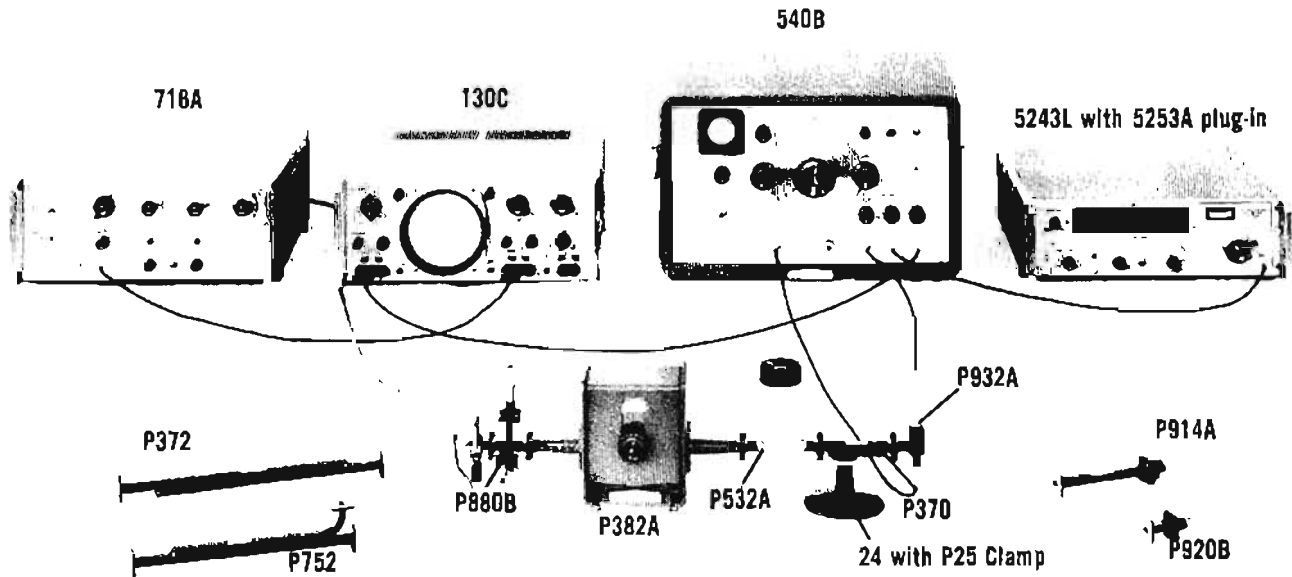

This group of instruments is used to calibrate an *hp* P532A Frequency Meter. A reflex klystron oscillator is used with its operating potentials furnished by an *hp* 716A Klystron Power Supply. Its frequency is swept by applying the internal sawtooth of the 716A to the repeller of the tube. The resulting FM is sufficient to show the absorptive response of the wave meter. Harmonics of the *hp* 540B Transfer Oscillator are mixed in the *hp* P932A and show up as a small "bug" on the oscilloscope trace. The counter (*hp* 5243L) is used to measure the transfer oscillator's fundamental frequency.

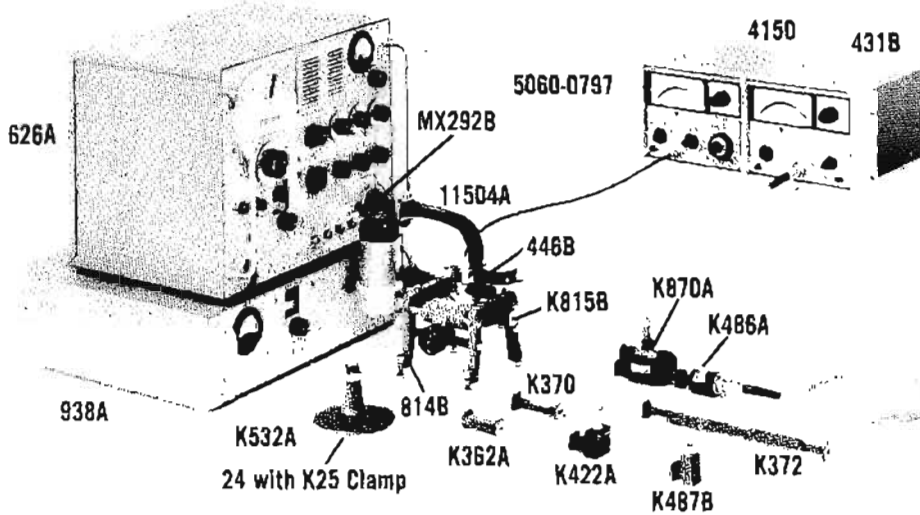

Here is a typical fixed-frequency measuring system. The hp 938A Frequency Doubler Set is used to translate the stable output of the hp 626 SHF Signal Generator up into K-band. Note how the hp 4150 SWR Meter and the hp 431B Power Meter mount in the rack adapter frame for small modular instruments. (See pages 18 and 19 for more information on modular enclosure accessories.)

K 18.0 GC to 26.5 GC

Instrument	Frequency Range	Characteristics	Price
626A Signal Generator and 938A Frequency Doubler Set	20 to 26.5 gc	Power monitor, 100 db attenuator; pulse, FM or square wave modulation (requires MX292B Adapter, \$40; X-band flexible waveguide, 11504A, \$35)	626A: \$3400 938A: \$1500
686C Sweep Oscillator and 938A Frequency Doubler Set	18 to 24.8 gc	Sweep all or part of range; pulse, square wave, FM and AM (requires MX292B, \$40; 11504A, \$35)	686C: \$2900 938A: \$1500
687C Sweep Oscillator and 938A Frequency Doubler Set	24.8 to 26.5 gc	Sweep all or part of range; pulse, square wave, FM and AM (requires MP292B, \$40; 11503A, \$48)	687C: \$3400 938A: \$1500

Model*	Description	Accuracy	Range	SWR (max.)	Power (watts)	Length (inches)	Page Reference	Price
X362A	Low Pass Filter	Insertion Loss, Pass-band: <1 db Stopband: >40 db	Pass: 18 to 26.5 gc Stop: 31 to 80 gc	Passband 1.5		2 1/2	186	\$385
K370	Attenuators, fixed	±20%	3, 6, 10, 20 db	1.15	0.5	3 1/4	187	\$115
K372	Attenuators, precision fixed	±0.5 db	10, 20 db	1.05	0.5	11 1/2	187	\$240
K375A	Attenuator, flap	±1 db at <10 db ±2 db at >10 db	0 to 20 db	1.15	0.5	4 1/2	187	\$185
K382A	Attenuator, precision variable	±2% or 0.1 db	0 to 50 db	1.15	2	7 3/4	188	\$475
K422A	Detector	Freq. Resp: ±2 db Sens: 0.1 v dc/mw cw		2.5	0.1		193	\$200 \$440 (matched pair)
K486A	Thermistor Mount, compensated		0.001 to 10 mw	2.0		2 3/4	199	\$300
K487C	Thermistor Mount, broadband		0.01 to 10 mw	2.0		1 3/8	196	\$225
K532A	Frequency Meter, direct reading	±0.077% at 23°C ±0.11% overall				4 1/2	204	\$350
K752	Directional Couplers, multi-hole	Mean: ±0.7 db Variation: ±0.5 db	3, 10, 20 db	1.1 1.05 1.05	0.5	10 3/4 9-15/16 9-15/16	232-233	\$200
X815B (814B) (446B)	Slotted Section, waveguide (Carriage for 815B) (Detector Probe for 814B)			1.01		7-9/16	238	\$265 (\$225) (\$145)
K870A	Tuner, slide screw	Insertion Loss: <3 db at 20:1 swr	Corrects swr of 20			4 1/4	239	\$250
K914B	Moving Load	Load Reflection: <1%	>1/2 wavelength	1.01	0.5	8 1/4	241	\$250
K920B	Adjustable Short		>1/2 wavelength			5 1/2	241	\$155
K25	Waveguide Clamp						179	\$2.50
24	Waveguide Stand						179	\$3

*Circular flange adaptor (UG-425/U) hp 11515A, \$35 each.

Data subject to change without notice.

18.0 to 40.0 GC

Here is a broad band swept frequency system using the hp 940A Frequency Doubler. The doubler takes the output of a P-band sweep oscillator (hp 687C) and translates it up to R-band. The equipment is set up to measure reflections in terms of the magnitude of a 1000 cps modulation signal displayed on an oscilloscope. The hp 415D is used as a pre-amplifier for the oscilloscope. Below is a typical trace; the dashed line was drawn on the CRT face as a calibration mark.

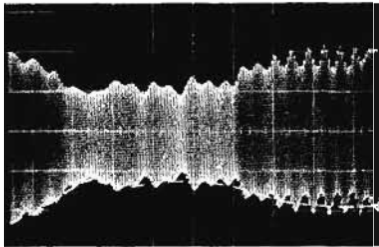
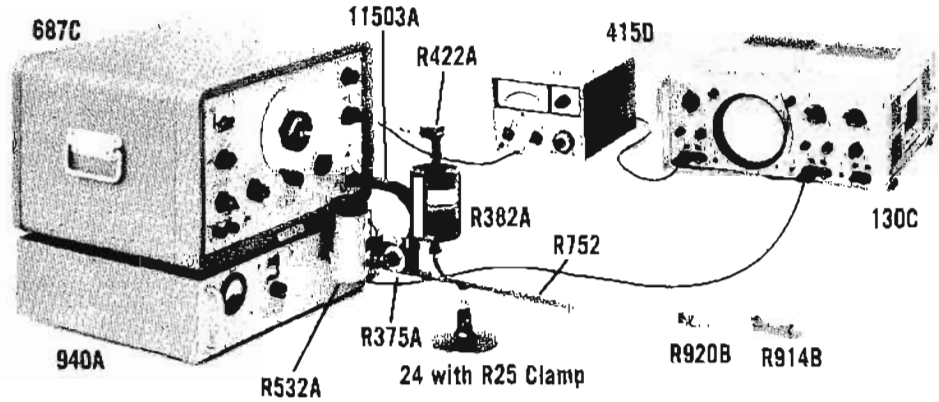

R 26.5 GC to 40 GC

Instrument	Frequency Range	Characteristics	Price
626A Signal Generator and 940A Frequency Doubler Set	26.5 to 31 gc	Power monitor, 100 db attenuator; pulse, FM or square wave modulation (requires NP292A Adapter, \$40; P-band flexible waveguide, 11503A, \$48)	626A: \$3400 940A: \$1500
628A Signal Generator and 940A Frequency Doubler Set	30 to 40 gc	Same as above	628A: \$3400 940A: \$1500
687C Sweep Oscillator and 940A Frequency Doubler Set	26.5 to 36 gc	Sweep all or part of range; pulse, square wave, FM and AM (requires MP292B, \$40; 11503A, \$48)	687C: \$3400 940A: \$1500

Model*	Description	Accuracy	Range	SWR (max.)	Power (watts)	Length (inches)	Page Reference	Price
R362A	Low Pass Filter	Insertion Loss, Pass-band: <2 db, Stop-band Rej.: >35 db	Pass: 26.5 to 40 gc Stop: 47 to 120 gc	Passband 1.8		1-21/32	186	\$385
R370	Attenuators, fixed	±20%	3, 6, 10, 20 db	1.15	0.5	3	187	\$125
R372	Attenuators, precision fixed	±0.5 db	10, 20 db	1.05	0.5	10	187	\$275
R375A	Attenuator, flap	±1 db at <10 db ±2 db at >10 db	0 to 20 db	1.15	0.5	4 3/8	187	\$200
R382A	Attenuator, precision variable	±2% or 0.1 db	0 to 50 db	1.15	1	7 1/2	188	\$500
R422A	Detector	Freq: Resp.: ±2 db Sens.: 0.1 v dc/mw cw		3	0.1		193	\$200 \$440 (matched pair)
R486A	Thermistor Mount, compensated		0.001 to 10 mw	2		3	199	\$375
R487B	Thermistor Mount, broadband		0.01 to 10 mw	2		1 3/8	196	\$275
R532A	Frequency Meter, direct reading	±0.083% at 23°C ±0.12% overall				4 1/2	204	\$400
R752	Directional Couplers, multi-hole	Mean: ±0.7 db Variation: ±0.5 db	3, 10, 20 db	1.1 1.05 1.05	0.5	11 3/4 8 3/8 8-23/32	232-233	\$250
R815B (814B) (446B)	Slotted Section, waveguide (Carrier for 815B) (Detector Probe for 814B)			1.01		7-9/16	238	\$265 (\$225) (\$145)
R870A	Tuner, slide screw	Insertion Loss: <3 db at 20:1 swr	Corrects swr of 20			4 3/8	239	\$300
R914B	Moving Load	Load Reflec.: <1%	>1/2 wavelength	1.01	0.5	7	241	\$250
R920B	Adjustable Short		>1/2 wavelength			4 1/2	241	\$165
R25	Waveguide Clamp						179	\$2.50
24	Waveguide Stand						179	\$3

*Circular flange adapter (UG-381/U) hp 11516A, \$40 each.

Data subject to change without notice.

M-BAND 10 to 15 GC

Model	Description	Accuracy	Range	SWR (max.)	Power (watts)	Length (inches)	Page Reference	Price
M362A	Low Pass Filter	Insertion Loss Passband: <1 db Stopband: >40 db	Pass: 10 to 15.5 gc Stop: 19 to 47 gc	Passband 1.5		4-15/32	186	\$350
M375A	Attenuator, flap	± 1 db at <10 db ± 2 db at >10 db	0 to 20 db	1.15	1	4 1/4	187	\$190
M382A	Attenuator, variable precision	$\pm 2\%$ or 0.1 db which ever is greater	0 to 50 db	1.15	10	13 1/4	188	\$400
M421A	Detector Mount	Freq. Resp.: ± 2 db Sens.: 0.05 v dc/mw cw	-40 to 0 dbm	1.5			193	\$175 \$370 (matched pair)
M486A	Thermistor Mount, compensated		0.001 to 10 mw	1.5		3	199	\$195
M487B	Thermistor Mount, broadband		0.01 to 10 mw	1.5		15/16	196	\$110
M532A	Frequency Meter, direct reading	$\pm 0.053\%$ at 23°C $\pm 0.085\%$ overall				4 1/2	204	\$300
M752	Directional Couplers, multi-hole	$\pm 0.4, \pm 0.5$ db	3, 10, 20 db	1.1 1.05 1.05	1	16-5/16 15-11/14 15-11/16	232-233	\$175
M810B (809B) (444A)	Slotted Section, waveguide (Carriage for 810B) (Detector Probe for 809B)		10 cm	1.01		10 1/4	236-237	\$175 (\$175) (\$85)
M870A	Tuner, slide screw	insertion Loss: <2 db at 20:1 swr	Corrects swr of 20			5 7/8	239	\$170
M914A	Moving Load	Load Reflection: <0.5%	>1/2 wavelength	<1.025	1	8-1/16	241	\$85
M920A	Adjustable Short		>1/2 wavelength			4-13/16	241	\$125
M25	Waveguide Clamp						179	\$2.50
24	Waveguide Stand						179	\$3
Instrument		Frequency Range		Characteristics				Price
626A Signal Generator		10 to 15.5 gc		Output +10 dbm to -90 dbm; pulse, FM or square wave modulation; direct calibration				\$3400 \$3420 (R)

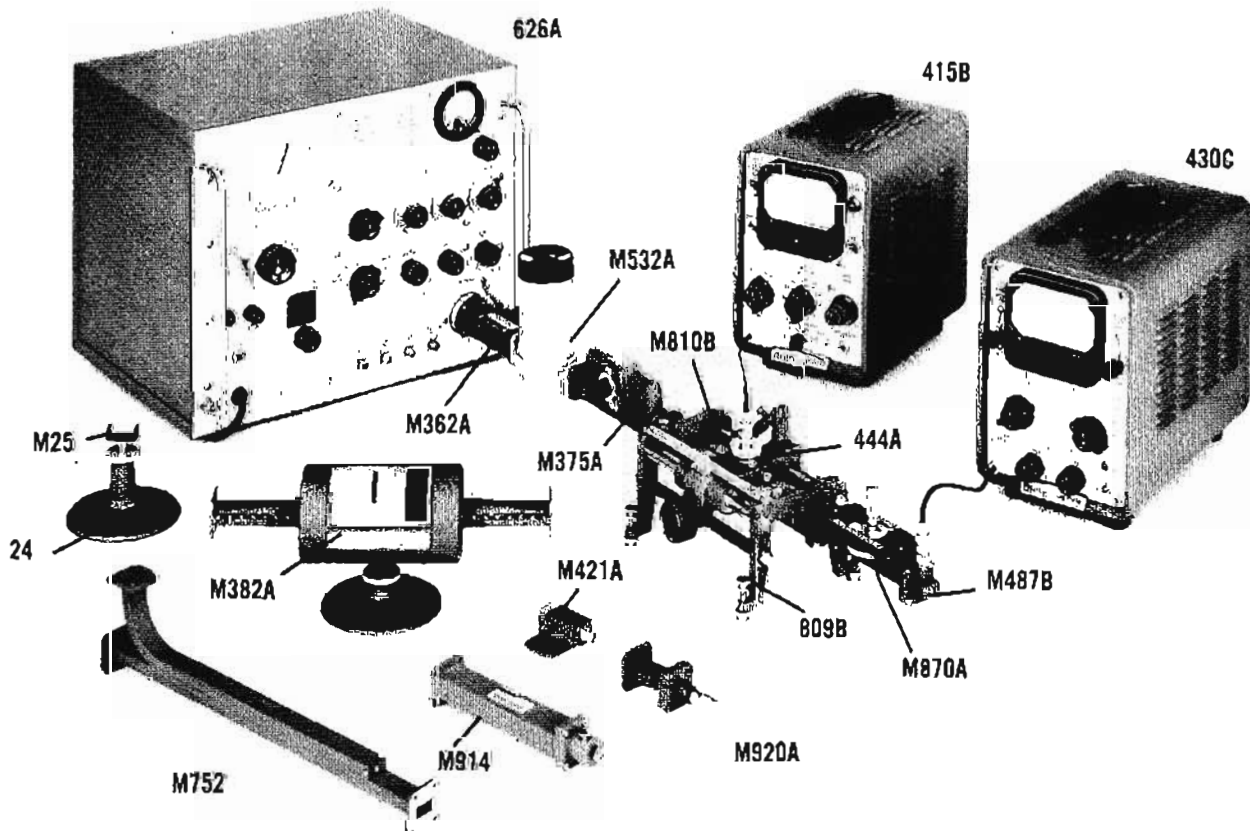

This photograph shows a fixed frequency setup for measuring power. Such a setup, for example, could be used to measure the resonant dip of the M532A Wavemeter. The M870A Slide Screw Tuner tunes the M487B Thermistor Mount to unity swr for improving measuring accuracy.

hp 281A, 290A, 292A,B ADAPTERS, 24 WAVEGUIDE STAND, 25 WAVEGUIDE CLAMPS

Fitted with a standard Type N female connector and a plain AN flange, *hp* 281A Waveguide-to-Coaxial Adapters use a probe with a low-loss dielectric sheath to transform waveguide impedance into coaxial impedance. Power may be transmitted in either direction, and each adapter covers the full frequency range of its waveguide band with swr less than 1.25.

The *hp* 290A Cover-to-Choke Flange Adapter consists of a short waveguide section with a precision AN cover flange on one end and a choke flange on the other. The *hp* 290A is used to connect between non-precision cover flanges (such as those found in choke flange systems) and *hp* precision cover flange equipment. The choke section of the 290A mates with the non-precision flange to prevent loss of energy through the joint.

Models 292A and B Waveguide-to-Waveguide Adapters connect two different waveguide sizes with overlapping frequency ranges. The 292A consists of a short tapered section of waveguide. The 292B is a broached casting with a step transition between waveguide sizes. Letter prefixes on the accompanying chart indicate band mating.

Cast and machined from zinc alloy, the *hp* 24 Waveguide Stand locks the *hp* 25 clamp at any height from 2 $\frac{3}{4}$ " to 5 $\frac{1}{4}$ ". The stand is 2 $\frac{1}{2}$ " high, and the base measures 4 $\frac{3}{4}$ " in diameter. Price, \$3.

Offered in 9 sizes to fit waveguide equipment covering frequencies from 2.6 to 40 gc, *hp* 25 Waveguide Clamps are designed for use with *hp* 24 stands. They consist of a rubber molding with a steel insert. Price, \$2.50.

Model	Waveguide Size (outside dimensional)
S25	3" x 1 $\frac{1}{2}$ "
G25	2" x 1"
J25	1 $\frac{1}{2}$ " x 3 $\frac{3}{4}$ "
H25	1 $\frac{1}{4}$ " x 5 $\frac{3}{8}$ "
X25	1" x 1 $\frac{1}{2}$ "
M25	0.850" x 0.475"
P25	0.702" x 0.391"
K25	0.500" x 0.250"
R25	0.360" x 0.220"

281A Adapters		290A Adapters			Frequency Range gc	Fits Waveguide Size (in.)
Model	Price	Model	Price	Length (in.)		
S281A	\$50	S290A	\$65	3	2.60 - 3.95	3 x 1 $\frac{1}{2}$
G281A	\$40	G290A	\$55	2	3.95 - 5.85	2 x 1
J281A*	\$35	J290A**	\$40	1 $\frac{3}{4}$	5.30 - 6.2	1 $\frac{1}{2}$ x 3 $\frac{3}{4}$
H281A	\$30	H290A	\$35	1 $\frac{1}{2}$	7.05 - 10.0	1 $\frac{1}{4}$ x 5 $\frac{3}{8}$
X281A	\$25	X290A /	\$20	1 $\frac{1}{2}$	8.2 - 12.4	1 x 1 $\frac{1}{2}$
		P290A	\$30	1 $\frac{1}{8}$	12.4 - 18.0	.702 x .391

*SWR 1.30 from 5.3 to 5.5 gc
**Frequency Range 5.2 to 8.2 gc

292A Adapters				
Model	SWR	Length (in.)	Frequency Range gc	Price
HX292B	1.05	1 $\frac{1}{2}$	8.2 - 10.0	\$25
MX292B	1.05	2 $\frac{3}{8}$	10.0 - 12.4	\$40
MP292B	1.05	2 $\frac{1}{2}$	12.4 - 15.0	\$40
NP292A	1.05	2 $\frac{3}{4}$	15.0 - 18.0	\$40
NK292A	1.05	2 $\frac{3}{4}$	18.0 - 22.0	\$40

Data subject to change without notice.

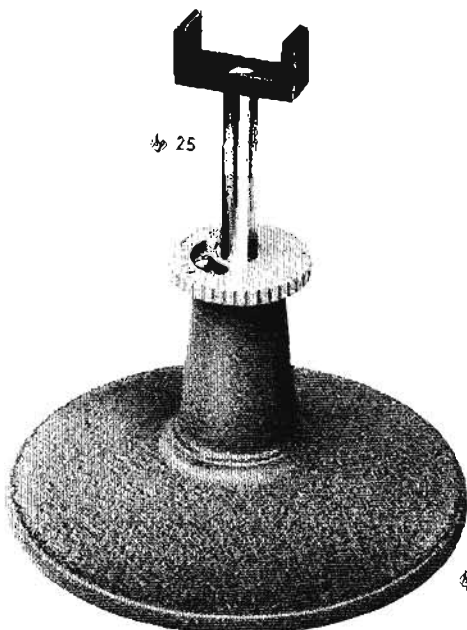

hp 25

hp 24

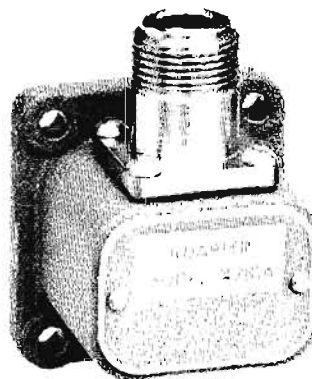

hp 281A

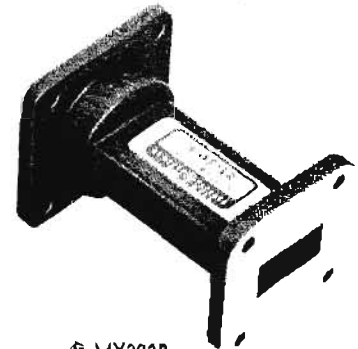

hp MX292B

hp COAXIAL INSTRUMENTATION

Hewlett-Packard offers an extensive line of instruments for coaxial systems operating to 12.4 gc. The tables and descriptive material on these two pages indicate the frequency range and function of these instruments. Additional specifications will be found on the pages referenced in the tables.

Frequency Coverage by Model											Page	Instrument Name	Uses	
10 DC mc	55 mc	215 mc	450 mc	500 mc	940 mc	1 gc	2 gc	3 gc	4 gc	10 gc	12.4 gc			
← 281A Series →											179	Waveguide to Coax Adapters	These adapters connect coaxial cables and waveguide systems. They are made for S- (2.6 to 3.95 gc), G- (3.95 to 5.85 gc), J- (5.3 to 8.2 gc), H- (7.05 to 10 gc) and X- (8.2 to 12.4 gc) bands.	
											186	Low Pass Filters	Pure signals are needed in many measurements because the presence of harmonics can cause erroneous readings or mask a null when measuring standing wave ratio. These filters have a rejection of ≥ 50 db at 1.25 times their cut-off frequency and effectively eliminate harmonics.	
											189	Attenuators	Precision variable attenuators are particularly useful for measuring the insertion loss of components by rf substitution. In this method, power is fed through the attenuator to a detector and to a reference meter. Then the unknown component is inserted and the attenuation of the variable attenuator is reduced to obtain the previous meter reading. The difference in attenuator settings is the insertion loss of the unknown component. Insertion loss measurements up to 80 or 90 db are easily made if the detector (which may be a receiver) has adequate sensitivity. RF substitution has the advantage that the detector characteristics need not be known, since the input to the detector is constant.	

Frequency Coverage by Model											Page	Instrument Name	Uses		
DC	10 mc	55 mc	215 mc	450 mc	500 mc	940 mc	1 gc	2 gc	3 gc	4 gc	10 gc	12.4 gc			
											193 191 237	Detectors	Basically, these detectors are square-law devices for demodulating rf signals. The 420B and 476A exhibit excellent square-law properties hence they are particularly useful in reflectometer applications or for measuring attenuation directly with a Model 415B,D SWR meter or a Model 416B Ratio-meter (pages 190 to 193).		
											196 199	Thermistor Mounts	The 477B and 478A are used with the 430C (page 196) and the 431B (page 198) Power Meters respectively for measuring power in Type N systems. Model 478A is temperature-compensated and permits measurements as low as 1 μw.		
											204	Wavemeter	Model 536A is a reaction wavemeter for measuring frequencies from 960 mc to 4.2 gc. Resonance is indicated by a sharp dip in the output.		
											232	Dual Directional Couplers	Because of their extremely high directivity (> 30 db), these dual directional couplers are especially useful in coaxial reflectometer applications. Their low insertion loss and high power handling capability make them suitable for permanent installation in a transmission line for power monitoring. They may be used to increase the range of the 430C or 431B.		
											234	VHF Detector VHF Bridge	These instruments and a suitable signal generator, such as an hp 608C (page 212), permit direct measurement of impedance magnitude and phase from 2 to 2000 ohms and from 0° to ± 90°. (Slotted lines for this frequency region are long and cumbersome.)		
											235 237	Slotted Lines	Slotted lines are used to measure swr and to determine reflection coefficient, return loss, mismatch loss and impedance.		
											239	Slide Screw Tuner	A slide-screw tuner is an impedance matching device, usually used to maximize the power delivered to a load. Slide-screw tuners have less loss than single or double stub tuners; also, the adjustments do not interact.		
											241	Terminations	Used to terminate 50-ohm coaxial systems in their characteristic impedance during swr measurements and as production line impedance standards. Model 906A has a sliding load so that its small reflection may be separated from other reflections in a system.		

NOISE FIGURE

In microwave communications, the weakest signal that can be detected is usually determined by the amount of noise added by the receiving system. Thus, any decrease in the amount of noise generated in the receiving system will produce an increase in the output signal-to-noise ratio equivalent to a corresponding increase in received signal. From a performance standpoint, an increase in the signal-to-noise ratio by reducing the amount of noise in the receiver is more economical than increasing the received signal level by raising the power of the transmitter. For example, a 5 db improvement in receiver noise figure is equivalent to increasing the transmitter power by 3:1.

The noise appearing at the output of a receiver or an amplifier is the sum of the noise arising from the input termination (source) and the noise contributed by the receiver or amplifier itself. The noise factor is the ratio of the actual output noise power of the device to the noise power which would be available if the device were perfect and merely amplified the thermal noise of the input termination rather than contributing any noise of its own. Noise figure is noise factor expressed in db.

The noise figure of a receiver may be measured by using a signal generator input and an output power (square law) detector. However, this method is time consuming and has the added disadvantage that the effective power gain-bandwidth characteristics of the device must be determined. Moreover, the available signal power may be difficult to determine accurately at the low levels involved.

Automatic noise figure measurements using standard broadband noise sources which supply a noise spectrum of known power, flat with frequency, overcome the drawbacks of the signal generator method. At intermediate and low radio frequencies temperature limited diodes are suitable as excess noise sources, while at microwave frequencies gas discharge tubes in suitable waveguide sections are both accurate and reliable. Hewlett-Packard Noise Figure Meters use the noise source technique.

Automatic noise figure measurements with Hewlett-Packard Noise Figure Meters depend upon the periodic insertion of a known excess noise power at the input of the device under test. Subsequent detection of the noise power in later IF stages of the device results in a pulse train of two power levels. The power ratio of these two levels contains

the desired noise figure information. For instance, in the simplified diagram of Figure 1, the various contributions of noise power to the output pulse ratio are shown.

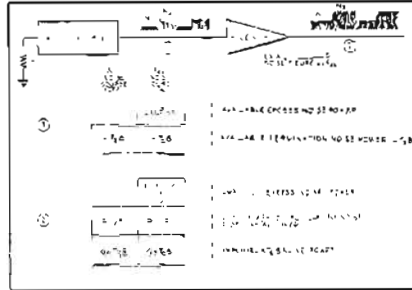

Figure 1. Automatic noise figure measurement of microwave device (composition of noise power).

kT_0B is the available noise power from the reference load where:

k = Boltzmann's constant

T_0 = Temperature of reference load in degrees Kelvin

B = Bandwidth of measuring system

Excess noise power added by the noise source is based on the effective fired temperature of the source. An argon gas discharge, for instance, is 15.2 db above the reference temperature power. Then the total noise power output of the receiver with noise source "Off" is:

$$N_1 = GkT_0B + RCVR \quad (1)$$

where G is receiver power gain

and total noise power output of the receiver with noise source "On" is:

$$N_2 = GkT_0B + RCVR + EXCESS \times (G) \quad (2)$$

Noise factor is defined above as:

$$F = \frac{GkT_0B + RCVR}{GkT_0B}, \text{ or} \quad (3)$$

(Total noise output from device)
(Output power IF noiselessly amplified)

So:

$$RCVR = (F - 1) GkT_0B \quad (4)$$

which is noise output power contributed by the RCVR.

Also the excess noise power from the gas discharge at the input is:

$$EXCESS = \left(\frac{T_2 - T_0}{T_0} \right) kT_0B \quad (5)$$

where T_2 is the effective fired temperature of the noise source.

Then the ratio at the output: $\frac{N_2}{N_1} =$

$$\frac{GkT_0B + (F-1)GkT_0B + \left(\frac{T_2 - T_0}{T_0} \right) GkT_0B}{GkT_0B + (F-1)GkT_0B} \quad (6)$$

by substitution
from (1), (2), (4), & (5)

And

$$F = \frac{\left(\frac{T_2 - T_0}{T_0} \right)}{\left(\frac{N_2 - N_1}{N_1} \right)} \quad (7)$$

Note that the gain-bandwidth factor (GB) has disappeared.

Finally (8)

$$F_{db} = 10 \log \left(\frac{T_2}{T_0} - 1 \right) - 10 \log \left(\frac{N_2}{N_1} - 1 \right)$$

The first term is a known quantity and expressed in db of excess noise ratio.

If an argon discharge excess noise ratio is 15.2 db:

Then:

$$F_{db} = 15.2 - 10 \log \left(\frac{N_2}{N_1} - 1 \right) \quad (9)$$

Thus the ratio $\frac{N_2}{N_1}$ contains the de-

sired noise figure information. Hewlett-Packard Models 340B, 342A, and 344A Noise Figure Meters measure noise figure as a function of this ratio.

Model 340B requires a 30 or 60 megacycle input from the device under test. Input circuitry of the 342A features a vhf converter which provides for 5 input frequencies: 30, 60, 70, 105 and 200 megacycles, other frequencies available.

The hp 344A Transistorized Noise Figure Meter has been specifically designed for radar system applications where time-shared noise figure measurements are extremely important to assure that radar sets are operating at peak performance. Sensitivity has been made very high to permit noise sources to be decoupled by as much as 20 db from the main transmitter line. Alarm circuitry for remote indication of excessive noise figure, as well as remote metering of noise figure, is available in the 344A.

Hewlett-Packard noise sources are available for all frequencies between 10 megacycles and 18,000 megacycles to allow measurements on all rf devices in this range. Sources have been specifically designed for very low fired and unfired swr to lower coupling ambiguities of the excess noise ratio into the device under test. Waveguide sources have been loaded with resonance suppressing polyiron loads to eliminate high swr at points in the band caused by the insertion of the noise tube in waveguide.

For further information on automatic noise measurements, write for *Journal* Vol. 9, No. 5 and Vol. 10 No. 6-7. Application Note #43 describes radar system noise measurements.

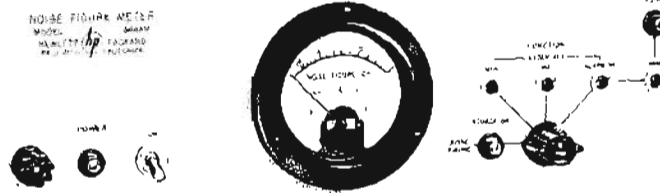

The *hp* 344A Noise Figure Meter permits measurement and continuous monitoring of the noise figure of operating radar sets. Operation is automatic, and calibration is a simple front panel procedure. High sensitivity of the 344A lets you decouple the noise source 20 db or more from the main receiver line to minimize system degradation. The 344A covers any rf range for which suitable noise sources are available.

Model 344A operates at a pulse repetition rate from 90 to 500 pps, and it can free-run for receiver measurements without requiring a system trigger. Special circuitry may be incorporated to sample noise characteristics at rates to 5000 pps. Usefulness and versatility of the 344A are enhanced by the design of the modulator as a separate unit, permitting the modulator to be mounted at a distance from the metering circuitry, as atop an antenna structure.

The 344A contains an alarm and noise source monitoring circuitry, as well as provisions for monitoring noise figure with a remote meter. High noise figures may also be measured with the 344A, whose sensitivity permits measuring noise figures as high as 40 db by tightening the coupling of the noise source to the measured device.

Specifications

hp 344A Noise Figure Meter

Input Frequency: 30 mc (Other frequencies between 15 mc and 40 mc, and between 50 mc and 100 mc, available on special order.)

Bandwidth: 1 mc nominal.

Input Sensitivity: Requires between 40 and 80 db receiver gain.

Input Impedance: 75 ohms or 50 ohms nominal, passive termination during radar scan time. Return loss greater than 20 db over a ± 4 megacycle band during radar scan time. (Other input impedances available on special order, but return loss specification degraded for impedances other than 75 ohms or 50 ohms.)

Meter Scales:

Option No.	Meter Range	Full Scale Reading	Accuracy*	Excess Noise (N _e)
(1)	200° K to 5000° K	200° K	± 10% 200° to 750° ± 20% 750° to 1500° ± 30% 1500° to 2500°	192° K (— 1.8 db)
(2)	0 to 15 db	0 db	± 0.5 db, 0 to 5 db ± 1 db, 5 to 10 db ± 2 db, 10 to 15 db	— 1.8 db
(3)	3 to 18 db	3 db	± 0.5 db, 3 to 6 db ± 1 db, 6 to 12 db ± 2 db, 12 to 18 db	— 1.8 db
(4)	6 to 20 db	6 db	± 0.5 db, 6 to 12 db ± 1 db, 12 to 15 db ± 2 db, 15 to 20 db	+ 1.2 db

* Accuracy specified does not include excess noise accuracy. Other meter options available on special order.

Repetition Rate: Any rate from 90 to 500 pps as specified. (Techniques available for operation above 500 pps.)

Acceptable Repetition Rate Variation: Specified rate + 25%, — 0%.

Measurement Duty Cycle: 0.075 minimum (measurement time/repetition period).

Total Duty Factor: 0.075 + (10⁻³ x PRF).

Input Trigger: 2 to 40 volt positive pulse, as specified, duration > 3 μsec, rise time < 1 μsec.

Noise Figure Alarm: Front panel lamp indicates when noise figure exceeds preset value. Settable for any noise figure level within ± 25% of meter mid-scale angular deflection. Accuracy relative to meter indication better than ± ¼ db (or ± 5%) over most of the settable range. Relay contacts provided for remote indication—shorted when preset value exceeded.

Source Alarm: Front panel lamp indicates when noise source is on. Relay contacts provided for remote indication — shorted when noise source off.

Output: 100 μa into 2000 to 4000 ohms at full scale meter reading for remote monitoring.

Environmental Conditions: Temperature: Operating, 0 to 52°C; storage — 52 to 70°C; humidity, 0 to 95%.

Power: 115 or 230 v ± 10%, or 208 v ± 10%, 50 to 100 cps. 20 to 40 watts, depending on noise source and duty cycle.

Dimensions: 8½" high, 6⅞" wide, 15½" deep behind panel, not including rear connectors (module); 5¼" high, 19" wide, 8" deep behind panel, not including rear connectors (rack mount).

Weight: Net 12 lbs. Shipping 20 lbs. (module); Net 13 lbs. Shipping 22 lbs. (rack mount).

Price: \$1650 (module or rack mount).

Specifications

hp 344A-78G Modulator

Operating Voltages: Supplied by *hp* 344A Noise Figure Meter.

Output Voltage: Modulator output designed to fire most *hp* waveguide noise sources and coaxial uhf noise sources, through 6-ft. cable.

Separation: Maximum separation between modulator and noise figure meter determined by maximum trigger path resistance of 15 ohms, maximum dc supply and ground path resistances of 0.5 ohm.

Environmental Conditions: Temperature: Operating, — 40 to 70°C; storage — 52 to 85°C; humidity, 0 to 95%.

Dimensions: 3⅞" high, 4⅝" wide, 4½" deep.

Weight: Net 2 lbs. Shipping 4 lbs.

Price: \$250.

Data subject to change without notice.

hp 340B, 342A NOISE FIGURE METERS
343A, 345B, 347A, 349A NOISE SOURCES

Direct-Reading Automatic Instruments Speed Noise Figure Measurements

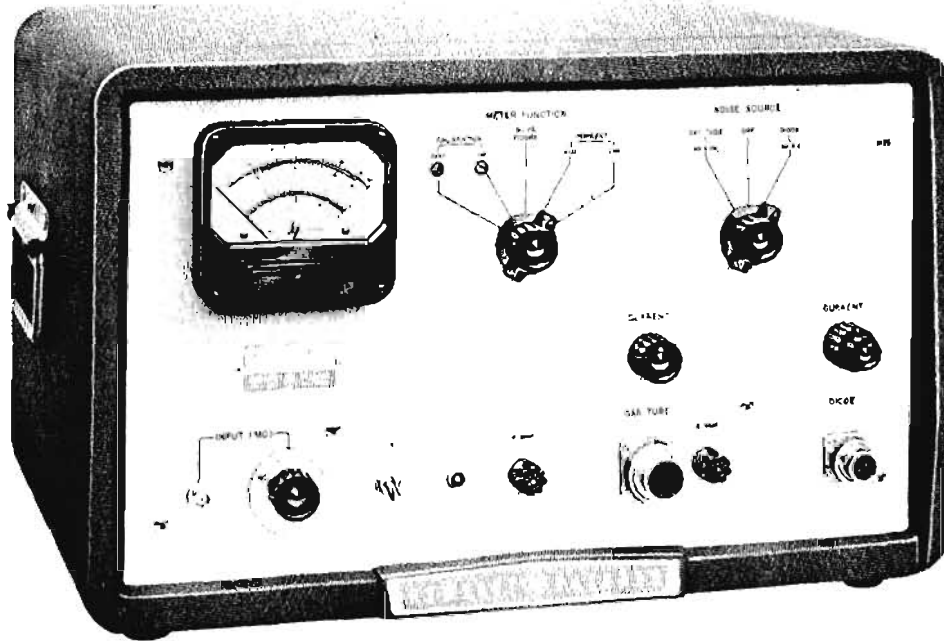

Ⓟ 342A

Advantages:

- Reads noise figure directly in db
- Completely automatic measurement
- Easily used by non-technical personnel
- No periodic recalibration needed
- Fast response; ideal for recorder operation

Uses:

- Measure noise figure in microwave or radar receivers, rf and IF amplifiers
- Compare unknown noise sources against known noise levels
- Adjust parametric amplifiers for optimum noise figure

Receiver and component alignment jobs that once took skilled engineers a full hour are now done in 5 minutes by a semi-skilled worker. Receiver noise figure can often be improved over the best adjustment previously possible. For instance, a 3 db improvement in receiver noise figure is equivalent to doubling transmitter output. Since accurate alignment is easy, equipment is better maintained and peak performance enjoyed regularly.

Above are some of the time-saving, cost cutting advantages of Hewlett-Packard noise figure measuring equipment, Models 340B and 342A, when used with coaxial and waveguide noise sources.

Model 340B Noise Figure Meter, when used with an Ⓟ noise source automatically measures and continuously displays the noise figure of IF or rf amplifiers tuned to 30 or 60 MC and of radar or microwave receivers with intermediate frequencies of 30 and 60 MC. Collectively, Ⓟ noise sources cover frequencies from 10 MC to 18 GC.

Five-Frequency Operation

Model 342A Noise Figure Meter is similar to Ⓟ 340B except that it operates on five frequencies between 30 and 200 MC. Four of these frequencies are normally 60, 70, 105 and 200 MC; the fifth is the basic 342A tuned amplifier frequency of 30 MC.

In operation, a noise source, either a gas discharge tube or a diode, is connected to the input of a device under test. The device's IF amplifier output is connected to the 340B or 342A. The Noise Figure Meter gates the noise source on and off. When the source is on the noise level is that of the receiver plus the noise source. When the source is off, the noise level is that of the device and its termination. The Noise Figure Meter automatically compares these two conditions and presents noise figure directly on a front panel meter. Rate of response is such that changes in noise figure are constantly indicated on the meter.

Ⓢ Noise Sources

Ⓢ 343A VHF Noise Source. Specifically for IF and rf amplifier noise measurement, a temperature-limited diode source with broadband noise output from 10 to 600 MC.

Ⓢ 345B IF Noise Source. Operates at either 30 or 60 MC, as selected by a switch. Another selector permits matching 50, 100, 200 and 400 ohm impedances.

Ⓢ 347A Waveguide Noise Source. Argon gas discharge tubes mounted in waveguide sections. For waveguide bands 2.6 through 18.0 GC, provide uniform noise throughout range; maximum SWR 1.2.

Ⓢ 349A UHF Noise Source. Argon discharge tubes providing 15.2 db excess noise for automatic noise figure readings 400 to 4,000 MC. Also available with 18.2 db excess noise.

Specifications

Ⓢ 340B Noise Figure Meter

Frequency Range: Depends on noise source used.

Noise Figure Range: 3 to 30 db, indication to ∞ with Waveguide Noise Source. 0 to 15 db, indication to ∞ with IF Noise Source.

Zero Offset: Permits low values to be read on sensitive external meter.

Accuracy (excluding source accuracy): ± 0.5 db, 10 to 25 db; ± 1 db, 3 to 10 db, 25 to 30 db with Waveguide Noise Source. ± 0.5 db, 0 to 15 db with IF Noise Source.

Input Frequency: 30 and 60 MC. Other frequencies between 10 and 70 MC on special order.

Input Requirements: -60 dbm to -10 dbm (noise source on). Corresponds to system gain before 340B of approximately 40 to 90 db with 347A or 349A noise source; approximately 50 to 100 db with 343A or 345B noise source.

Bandwidth: 1 MC nominal.

Input Impedance: 50 ohms, nominal.

AGC Output: Nominally 0 to -6 volts from rear binding posts.

Recorder Output: Maximum of 1 ma into maximum of 2,000 ohms to operate a recorder or remote meter.

Power Input: 115 or 230 v $\pm 10\%$, 50 to 60 cps, 185-435 watts depending on line voltage and noise source.

Power Output: Sufficient to operate Ⓢ 347A, Ⓢ 349A, Ⓢ 345B, or Ⓢ 343A Noise Sources.

Dimensions: Cabinet Mount: 20 $\frac{3}{4}$ " wide, 12 $\frac{3}{4}$ " high, 14 $\frac{1}{2}$ " deep. Rack Mount: 19" wide, 10 $\frac{1}{2}$ " high, 13 $\frac{7}{8}$ " deep behind panel.

Weight: Cabinet Mount: Net 40 lbs. Shipping 51 lbs.
Rack Mount: Net 34 lbs. Shipping 49 lbs.

Accessories Furnished: Ⓢ 340A-16A, 6' cable connects Ⓢ 340B to an Ⓢ 347A or 349A Noise Source.

Price: Ⓢ 340B, \$715.00 (cabinet); Ⓢ 340BR, \$700.00 (rack mount). (Not available in Western Europe.)

Ⓢ 342A Noise Figure Meter

(Same as 340B except as shown below)

Input Frequency: 30, 60, 70, 105 and 200 MC. (Other frequencies on special order.) Frequency selector switch.

Price: Ⓢ 342A, \$815.00 (cabinet); Ⓢ 342AR, \$800.00 (rack mount). (Not available in Western Europe.)

Ⓢ 343A VHF Noise Source

Frequency Range: 10 to 600 MC.

Excess Noise: 5.2 \pm 0.1 db, 10 to 200 MC.
5.2 \pm 0.25 db, 200 to 400 MC.
5.2 \pm 0.35 db, 400 to 600 MC.

Source Impedance: 50 ohms, SWR less than 1.2, 10 to 400 MC; less than 1.3, 400 to 600 MC.

Dimensions: 2 $\frac{3}{4}$ " wide, 2 $\frac{1}{2}$ " high, 5" deep.

Weight: Net $\frac{3}{4}$ lb. Shipping 2 lbs.

Price: Ⓢ 343A, \$100.00.

Option 01. Spare noise diodes calibrated with the instrument, \$40.00 each.

Ⓢ 345B IF Noise Source

(Same as 343A except as shown below)

Spectrum Center: 30 or 60 MC, selected by switch. Other frequencies between 10 and 60 MC on special order.

Excess Noise: Nominally 5.2 db into conjugate load.

Source Impedance: 50, 100, 200 and 400 ohms $\pm 4\%$ as selected by switch. Less than 1 pf shunt capacitance.

Price: Ⓢ 345B, \$100.00.

Ⓢ 347A Waveguide Noise Source

Model	Range, GC	Excess Noise, db	Approx. Length	Price
S347A	2.6 - 3.95	15.2 \pm 0.5	22 $\frac{1}{2}$ "	\$360.00
G347A	3.95 - 5.85	15.2 \pm 0.5	19"	285.00
J347A	5.7 - 8.2	15.2 \pm 0.5	19"	265.00
H347A	7.05 - 10	15.2 \pm 0.5	16"	250.00
X347A	8.2 - 12.4	15.2 \pm 0.5	14 $\frac{3}{4}$ "	200.00
P347A	12.4 - 18	15.2 \pm 0.5	14 $\frac{3}{4}$ "	250.00

SWR all models, fired or unfired, 1.2 max., less than 1.1 average.

Ⓢ 349A UHF Noise Source

Frequency Range: 400 to 4,000 MC; wider with correction.

Excess Noise: 15.2 \pm 0.5 db, including insertion loss. 18.2 db available on special order.

SWR: Up to 2,600 MC: less than 1.35 (fired); less than 1.5 (unfired)

2,600 to 3,000 MC: less than 1.5 (fired); less than 1.5 (unfired)

3,000 to 4,000 MC: less than 2.0 (fired); less than 3.0 (unfired)

(Source terminated in coaxial load with less than 1.05 SWR.)

Dimensions: 15" long, 3" wide, 2" high.

Weight: Net approximately 3 $\frac{1}{4}$ " lbs. Shipping 6 lbs.

Price: Ⓢ 349A, \$325.00.

Data subject to change without notice.

hp 360A-D, 362A LOW PASS FILTERS

Advantages:

- High attenuation beyond cut-off frequency
- Low insertion loss within passband
- Free from spurious response

These hp low pass filters facilitate microwave measurements by eliminating harmonics and permitting the transmission of energy at a single known frequency. The hp 360 filters consist of a brass tube that houses a multi-section coaxial type filter with the ends terminated in Type N fittings, one male and one female. Attenuation varies from less than 3 db in the passband to more than 50 db in the rejection band. Spurious response is down 50 db to three times cut-off frequency.

The hp 362A filters consist of a short section of waveguide having step transitions followed by transverse and longitudinal slots in the broad walls of the guide. The filters are fitted with precision cover flanges to insure low system swr. Transmission efficiency is high, and the stop band is broad. Rejection is more than 35 db in R-band, 40 db in all other bands.

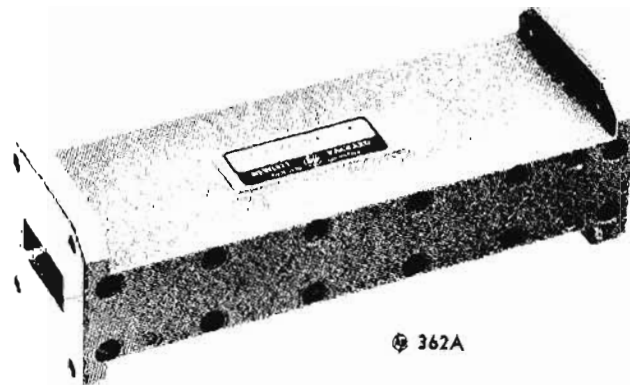

362A

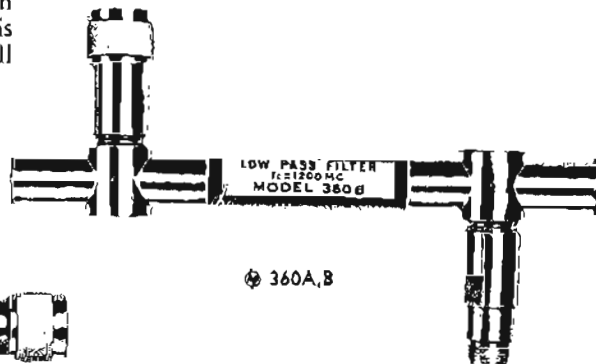

360A, B



360C, D

Specifications	360A	360B	360C	360D
Cut-off frequency	700 mc	1200 mc	2200 mc	4100 mc
Insertion Loss	Not over 3 db throughout passband (dc to cut-off)			
Reflection	50 db or more attenuation from 1.25 times cut-off frequency to 3-times cut-off frequency			
Impedance	50 ohms through passband; should be matched for optimum performance			
SWR	Less than 1.6 to within 100 mc of cut-off		Less than 1.6 to within 200 mc of cut-off	Less than 1.6 to within 300 mc of cut-off
Overall length (in.)	10 3/4	7-7/32	10-25/32	7 1/2
Outer diameter (in.)	3/8	3/8	3/8	3/8
Center line to male end (in.)	2-5/16	2-5/16
Center line to female end (in.)	2 1/4	2 1/4
Shipping weight	2 lbs.	2 lbs.	2 lbs.	2 lbs.
Price	\$70	\$60	\$50	\$50

Specifications	X362A	M362A	P362A	N362A	K362A*	R362A*
Passband (gc)	8.2-12.4	10.0-15.5	12.4-18.0	15.0-21.0	18.0-26.5	26.5-40.0
Stop band (gc)	14-37.5	19-47	23-54	29-63	37-80	47-120
Insertion loss	Less than 1 db	Less than 1 db	Less than 1 db	Less than 1 db	Less than 1 db	Less than 2 db
Stop Band Rejection	At least 40 db	At least 40 db	At least 40 db	At least 40 db	At least 40 db	At least 35 db
SWR	1.5	1.5	1.5	1.5	1.5	1.8
Waveguide size (in.)	1x.5	.850x.475	.702 x .391	.590x.336	.500x.250	.360x.220
Length (in.)	5-11/32	4-15/32	3-11/16	3-1/32	2 1/2	1-21/32
Weight (oz.)	13	9	6	5	2	1
Price	\$325	\$350	\$350	\$350	\$385	\$385

*Circular flange adapters:
 K-Band (UG-425/U) hp 11515A, \$35 each
 R-Band (UG-381/U) hp 11576A, \$40 each

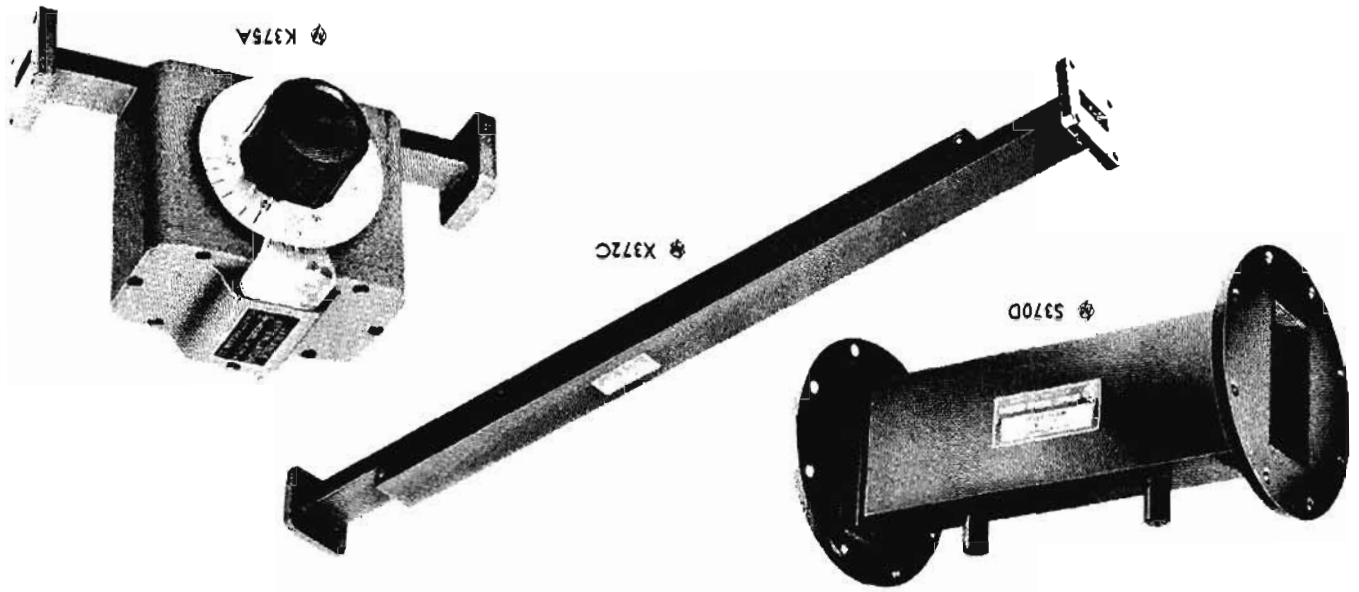

Model 372 Precision Attenuators are rugged, dependable, broadband instruments, remaining precisely calibrated regardless of humidity, temperature or age. Models with either 10 or 20 db of attenuation are offered. SWR is 1.05; mean attenuation is within ± 0.4 db (± 0.7 db for K- and R-bands) from nominal; variation across band is less than ± 0.5 db from mean. Calibration within ± 0.1 db may be obtained at 10 points across the band as an extra-cost option. (Calibration is normally furnished at 5 points.)

372 Precision Attenuators

Model	Frequency (mc)	Power (watts)	Length (in.)	Waveguide Size (in.)	Price
S370	2.6 - 3.95	1.0	12	3 x 1 1/2	\$100
G370	3.95 - 5.85	1.0	10 3/8	2 x 1	\$95
J370	5.30 - 8.2	1.0	8 3/8	1 1/2 x 3/4	\$85
H370	7.05 - 10.0	1.0	6 3/8	1 1/4 x 5/8	\$75
X370	8.2 - 12.4	1.0	5 1/4	1 x 1/2	\$65
P370	12.4 - 18.0	1.0	4 3/8	7/2 x .391	\$80
K370***	18.0 - 26.5	0.5	3 3/4	1/2 x 1/4	\$115
R370***	26.5 - 40.0	0.5	3	.360 x .220	\$125

These attenuators are waveguide sections providing fixed amounts of attenuation. They are useful in reducing power flowing in a waveguide system, reducing reflection of loads or sources, or isolating parts of a waveguide system. They consist of rectangular waveguide sections containing a rigidly mounted resistive strip. The resistive strip has been carefully designed to keep SWR less than 1.15 and attenuation constant over the full waveguide band. Accuracy over the band is within $\pm 20\%$ of the nominal attenuation. The 370 is available in attenuations of 3, 6, 10 and 20 db. Either end may be used as the input.

370 Fixed Waveguide Attenuators

For 3 db attenuation, add suffix "A" to model number; for 6 db, add "B"; for 10 db, add "C"; for 20 db, add "D".
 For 10 db attenuation, add suffix "C" to model number; for 20 db, add "D".
 ***Circular flange adapters: K-Band (UG-425/C) hp 11512A, R-Band (UG-381/U) hp 11516A, \$35 each.
 \$40 each.

Model	Frequency (mc)	Power (watts)	Length (in.)	Waveguide Size (in.)	Price
S375A	2.6 - 3.95	2.0	14 1/8	3 x 1 1/2	\$165
G375A	3.95 - 5.85	2.0	13	2 x 1	\$145
J375A	5.3 - 8.2	2.0	13	1 1/2 x 3/4	\$135
H375A	7.05 - 10.0	2.0	8 1/4	1 1/4 x 5/8	\$125
X375A	8.2 - 12.4	2.0	7-3/16	1 x 1/2	\$100
M375A	10.0 - 15.0	1.0	6 1/4	.850 x .475	\$190
P375A	12.4 - 18.0	1.0	7 1/4	.702 x .391	\$135
K375A***	18.0 - 26.5	0.5	4 1/2	.500 x .250	\$185
R375A***	26.5 - 40.0	0.5	4 3/8	.360 x .220	\$200

Variable flap attenuators provide a simple, convenient means of adjusting waveguide power level or isolating source and load. They consist of a slotted section in which a matched resistive strip is inserted. The degree of strip penetration determines attenuation. A dial shows average reading over the frequency band, and a shielded dust cover reduces external radiation and eliminates hand capacity effects. Attenuation is variable 0 to 20 db. Dial calibration is accurate within ± 1 db from 0 to 10 db, ± 2 db from 10 to 20 db. Maximum SWR is 1.15.

375A Variable Attenuators

Model	Frequency (mc)	Power (watts)	Length (in.)	Waveguide Size (in.)	Price
S372	2.6 - 3.95	2.0	46	3 x 1 1/2	\$425
G372	3.95 - 5.85	2.0	30	2 x 1	\$300
J372	5.85 - 8.2	1.0	22 3/4	1 1/2 x 3/4	\$190
H372	7.05 - 10.0	1.0	20 3/8	1 1/4 x 5/8	\$135
X372	8.2 - 12.4	1.0	19 1/8	1 x 1/2	\$110
P372	12.4 - 18.0	1.0	15 1/2	.702 x .391	\$125
K372***	18.0 - 26.5	0.5	11 1/2	.500 x .250	\$240
R372***	26.5 - 40.0	0.5	10	.360 x .220	\$275

hp 370, 372, 375A WAVEGUIDE ATTENUATORS

hp 382A, B, C PRECISION VARIABLE ATTENUATORS

hp 382A Attenuators

Operation of these direct reading, precision attenuators depends on a mathematical law, rather than on the resistivity of the attenuating material. Accurate attenuation from 0 to 50 db is assured regardless of temperature and humidity. The instruments can handle considerable power and feature large, easily read dials. Insertion loss at the zero setting is less than 1 db, and swr is less than 1.15. Accuracy is $\pm 2\%$ of reading or 0.1 db, whichever is greater.

hp 382B,C

The hp 382B,C extend the inherent advantages of the rotary vane attenuation principle into the range from 2.6 to 3.95 gc. To realize the merits of this attenuation principle the center barrel of the attenuator must be several wavelengths long. This length, in addition to that necessary to make smooth transitions from rectangular to circular guide, would result in S-band units of considerable size. The hp 382B,C, nonetheless, achieve both long electrical length and short physical dimensions. Dielectric loading in the attenuator decreases the velocity of the wave, thereby shortening its wavelength. The result is an S-band attenuator that is only 25 1/4" long, yet has 1% accuracy and a standing wave ratio less than 1.15.

The 382B is calibrated in degrees of rotation as well as in db (382B in 0.1° increments, 382C in 0.01° increments). This provides high resolution, as is desired in a transfer standard. In addition, the instruments provide attenuation from 0 to 60 db and are capable of handling 10 watts average power.

Specifications, hp 382B,C

Frequency Range: 2.6 to 3.95 gc.
 Calibrated Attenuation Range: 0 to 60 db.
 Accuracy: $\pm 1\%$ of reading or 0.1 db, whichever is greater, from 0 to 50 db; $\pm 2\%$ of reading above 50 db.

Specifications, hp 382A

Insertion Loss: Less than 1 db.
 SWR: Less than 1.15.
 Phase Shift Variation: Less than 5° from 0 to 60 db.
 Power: 10 watts continuous duty.
 Degree Dial: 0 to 90°; 382B calibrated in 0.1° increments, 382C calibrated in 0.01° increments.
 Waveguide Size: 3" x 1 1/2".
 Size: 25 1/4" long, 6" high, 8" deep.
 Weight: Shipping 28 lbs.
 Price: 382B, \$600; 382C, \$650.

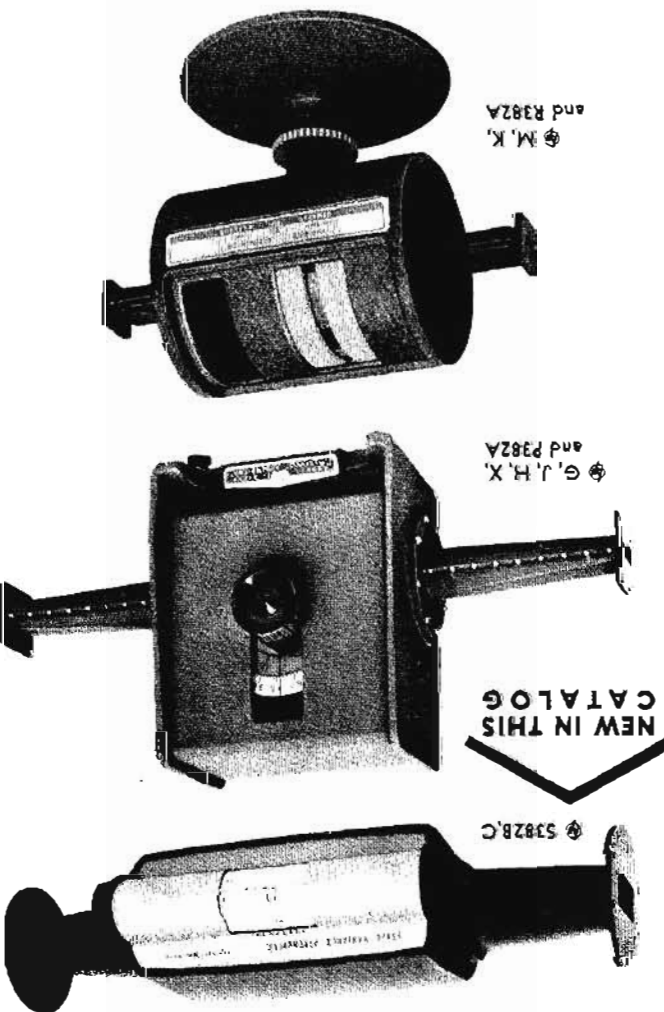

Model	Frequency Range (gc)	Waveguide Size (in.)	Power handling capacity, watts, average continuous duty	Size (in.) Length	Height	Depth	Weight (lb) Net	Shipping	Price
382A	3.95 - 5.95	2 x 1		31 5/8	9 5/8	7 1/2	25		\$500
382A	5.3 - 8.2	1 1/2 x 3/4		25 1/8	7-15/16	6 1/2	12		\$375
382A	7.0 - 10.0	1 1/4 x 5/8		20	7-15/16	6 1/2	10		\$350
382A	8.2 - 12.4	1 x 1/2		15 5/8	7 1/4	5 3/8	5		\$275
382A	10.0 - 15.0	3/4 x 3/8		10	13-7/32	5 1/2	4		\$400
382A	12.4 - 19.0	1/2 x 3/8		5	12 1/2	4 3/4	5		\$300
382A*	18.0 - 26.5	1/2 x 1/4		2	7 5/8	3 5/8	4		\$475
382A*	26.5 - 40.0	3/16 x 2/20		1	7 1/2	3 5/8	4		\$500

Circular flange adapters: K-Band (UG-425/U) hp 11515A, \$35 each, R-Band (UG-381/U) hp 11516A, \$40 each.
 For All Models:
 Dial Calibration Range: 0 to 50 db (above insertion loss at zero setting).
 Phase Shift Variation: Less than 3° from 0 to 50 db.
 Insertion Loss at Zero Setting: Less than 1 db.
 SWR: Less than 1.15 entire range of attenuation and frequency.
 Accuracy: $\pm 2\%$ of the reading in db, or 0.1 db, whichever is greater. Includes calibration error and frequency error.

355C,D, 393A, 394A VARIABLE COAXIAL ATTENUATORS



355C,D VHF Attenuators

Unique design provides accurate attenuation from dc to 1 gc with the *hp 355C* (0 to 12 db in 1 db steps) and *hp 355D* (0 to 120 db in 10 db steps). Attenuator sections are inserted and removed by cam-driven microswitches. These sections are adjusted by a time-domain reflectometry system to minimize reflections and assure high accuracy. Insertion loss is low, and using both instruments provides attenuation in 1 db steps to 132 db. The units can be connected with either terminal as input or output, and their small size and mounting versatility permit several installation schemes — even within other equipment.

393A, 394A Coaxial Attenuators

Each of these coaxial variable attenuators uses the principle of a directional coupler (see Figure 1) to achieve a wide range of attenuation over a full octave. Model 393A covers 5 to 120 db from 500 to 1000 mc. Model 394A covers 6 to 120 db from 1 to 2 gc. With special high power terminations, they will handle up to 200 watts average. Since these instruments are variable directional couplers, they are particularly useful for mixing signals while maintaining isolation.

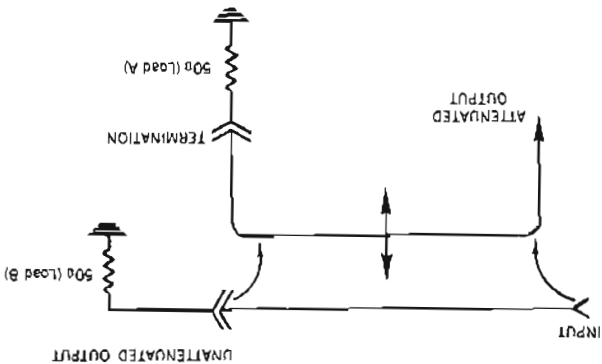
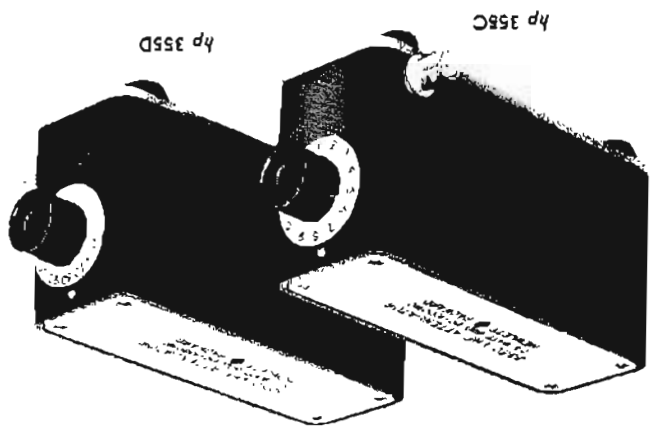
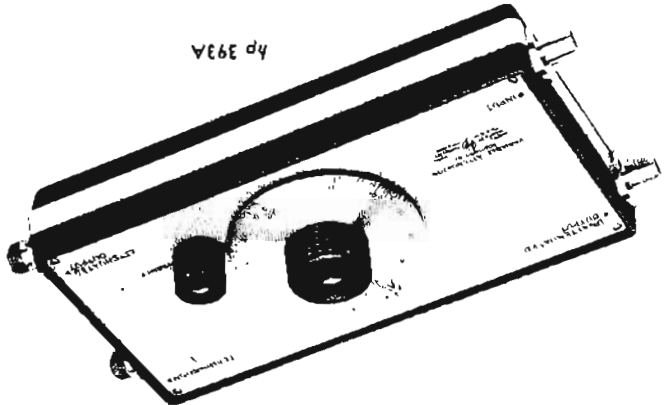

Figure 1. With loads A and B in place the instrument is an attenuator. With load A only, the instrument is a variable directional coupler.



NEW IN THIS
CATALOG

Specifications	
Attenuation:	12 db in 1 db steps 120 db in 10 db steps
Frequency Range:	dc to 1000 mc ± 0.3 db to 120 db at 1000 cps ± 1.5 db to 90 db at 500 mc ± 0.35 db dc to 1000 mc
Impedance:	50 ohms nominal 120 db below 1000 mc 120 db below 1000 mc
Power Dissipation:	0.5 watt average, 350 volts peak (input and output) 1.2 below 250 mc; 1.3 below 500 mc; 1.5 below 1000 mc
Maximum SWR:	0.2 db at 100 mc; 0.25 db to 500 mc; 1.5 db to 1000 mc
Dimensions (in.):	6 long, 2 3/4 wide, 2 3/4 high Net 1 1/2 lbs. Shipping 3 lbs.
Weight:	hp 355C, \$125; hp 355D, \$125
Price:	



Specifications	
Frequency Range:	500 to 1000 mc 1 to 2 gc
Attenuation or Coupling:	5 to 120 db, variable at least 10 db, 10 to 40 db attenuation
Directivity (with loads less than 1.05 swr):	± 1 db or ± 1% of dial reading, whichever is greater
Absolute Accuracy (between matched generator and load):	< 2.5, 5 to 15 db attenuation < 1.5, 15 to 30 db attenuation < 1.2, 30 to 120 db attenuation
SWR Input:	< 2.5, 5 to 15 db attenuation < 1.8, 10 to 15 db attenuation < 1.6, 15 to 120 db attenuation
SWR Output:	< 2.5, 5 to 15 db attenuation < 1.8, 10 to 15 db attenuation < 1.6, 15 to 120 db attenuation
Nominal Impedance:	50 ohms
Maximum Voltage:	500 volts peak
Average Power:	Approx. 200 watts maximum; power rating of terminations must be observed (0.5 watt terminations furnished)
Dimension (in.):	6 1/2 wide, 12 long, 2 3/4 deep Net 6 lbs. Shipping 13 lbs.
Weight:	hp 393A, \$420; hp 394A, \$420
Price:	

Data subject to change without notice.

The 415D consists of high-gain, low-noise solid state amplifier operating at a tuned audio frequency and a voltmeter calibrated for square-law detectors to read directly in SWR. The normal db scale covers 0 to 10 db, with a range attenuator covering 60 db in 10 db steps. The "expand-offset" feature activates the proper offset and gain change to normalize the meter reading automatically. Four separate expand ranges cover the complete 10 db scale in 2.5 sections. Concentric controls present direct readout on expanded as well as unexpanded scales.

A front panel screwdriver adjustment permits tuning the amplifier over a 50 cps range for ease in matching the signal source. Normal tuned frequency is 1000 cps, but frequencies between 400 and 2500 cps are available on special order. (Tuning frequency, however, should not be harmonically related to power line frequency.)

Another front panel screwdriver control permits continuous adjustment of instrument bandwidth from 12 to 130 cps to increase sensitivity with narrow bandwidths or increase bandwidth for sweep frequency testing. The 415D is designed to operate with bolometers or crystals. The 200-ohm bolometer input provides bias of 8.7 ma or 4.3 ma for barreters or instrument fuses. A rear panel control adjusts the bias $\pm 10\%$ of nominal value, the bias readable on the meter face. A 200-ohm crystal rectifier input is provided, as well as a high impedance input (200K) for crystal rectifiers when operating the instrument as a null detector. The bolometer bias supply is peak-limited.

AC and dc outputs are provided for use of the 415D as a high-gain tuned amplifier and with recorders. The solid state 415D may be operated with an internally mounted

415D SWR Meter

battery pack (optional extra) for completely portable use or to eliminate ground loops.

Specifications 415D

Input: Crystal: 200 ohms and 200K input impedance; bolometer: 8.7 ma and 4.3 ma bolometers; positive bolometer protection; BNC input connector.

Sensitivity: 0.1 μ v rms at 30 cps bandwidth; 0.04 μ v rms at minimum input connector.

Noise: At least 5 db below full scale with 0.1 μ v rms sensitivity (30 cps BW). At least 7.5 db below full scale with 0.1 μ v rms sensitivity (min. BW).

Frequency: 1000 cps, adjustable 5%; other frequencies available between 400 and 2500 cps.

Bandwidth: Variable, nominally 12 to 130 cps.

Range: 70 db in 10 and 2.5 db steps.

Accuracy: ± 0.1 db/10 db step, maximum cumulative ± 0.2 db; ± 0.1 db when switching from any 10 db step (Norm) to any 2.5 db step (Expand), except ± 0.05 db when switching to 0.0 (Expand); ± 0.02 db linearity on Expand scales.

Output: DC, 0 to 1 ma into 1500 ohms maximum at the recorder jack (one side grounded), ac, 0 to 1 v rms into 10K ohms minimum (one side grounded).

Meter Scale: 4 1/2" long mirrored scale calibrated for square law detectors; swt. 1 to 4; 5.2 to 10; 1 to 1.3 (Expand); db, 0 to 10, 0 to 2.5 (Expand); Bolometer bias.

Power: 115 or 230 v $\pm 10\%$, 50 to 1000 cps, 2 watts. Power line frequency or multiples thereof must not be at the tuned amplifier continuous operation.

Dimensions: 6 1/2" high, 7-25/32" wide, 12" deep.

Weight: Net 8 lbs. (11 lbs. with battery). Shipping 15 lbs. (18 lbs. with battery).

Accessories Available: 415C-95A Rechargeable Battery and Installation Kit, \$100; hp 10501A Cable Assembly, \$4.50; hp 10503A Video Cable Assembly \$6.50.

Price: hp 415D, \$325.

Options: 01. Rechargeable battery installed, add \$100; 02. Rear input connector wired in parallel with front panel input connector, add \$15.

Uses: Measure SWR, reflection coefficient, attenuation
Use as null indicator for audio frequency bridges

Advantages: Increased resolution with expand, offset provision giving full-scale expansion for any 2.5 db increment—no "blind" spots
Tunable amplifier to match source modulator
Variable bandwidth for optimum sweep frequency or high sensitivity testing
Built-in bolometer protection
Solid state, compact, low power consumption; portable operation optional

Useful for SWR, Reflection Coefficient, Attenuation, AF Null Measurements

hp 415D SWR METER

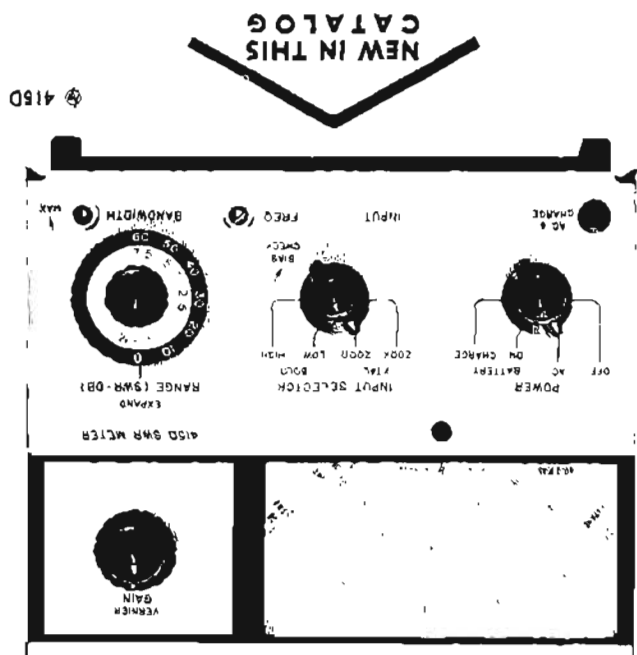

hp 415B STANDING WAVE INDICATOR

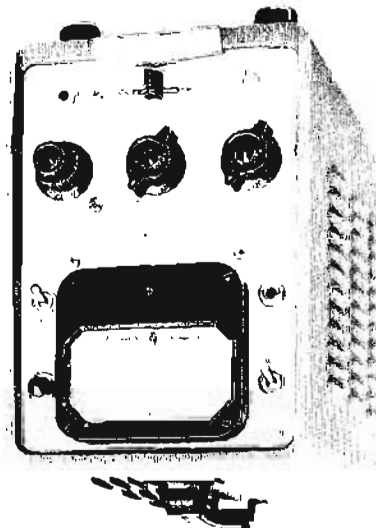

hp 415B Standing Wave Indicator

Similar to the hp 415D, this meter is a tuned voltmeter for SWR measurements with hp slotted lines and detector mounts. It is also useful as a null indicator for bridge measurements, with a 200K input circuit for this application. A 60 db attenuator adjustable in 10 db range steps provides a calibrated range of 70 db. An output is provided for use with a recording milliammeter, and a special 5 db attenuator is incorporated in order to increase resolution through use of the upper portion of the logarithmic meter scale. Inputs include a 200-ohm termination with bias of 4.3 or 8.7 ma, unbiased for crystals, or a 200K load for null measurements. A jack and monitor cable are provided for connecting an external milliammeter to measure bolometer current.

Specifications @ 415B

Input: "Bolt" (200 ohms), bias provided for 4.3 ma or 8.7 bolometer or 1/100 amp fuse; "Crystal", 200 ohms for crystal rectifier; "200,000 Ohms", high impedance for crystal rectifier as null detector; BNC connector. Noise: At least 5 db below full scale when operated from 200-ohm resistor at room temperature. Frequency: 1000 cps \pm 2%. Other frequencies, 315 to 2020 cps, available on special order. Bandwidth: 30 cps (nominal). Range: 70 db; input attenuator provides 60 db in 10 db steps, accuracy \pm 0.1 db per 10 db steps; max. cumulative error \pm 0.2 db. Scale Selection: "Normal", "Expand" and "5 db". Output: Jack provided for recording milliammeter having 1 ma full scale deflection and internal resistance of 1500 ohms or less. Meter Scales: SWR 1 to 4, SWR 3 to 10, expanded SWR 1 to 1.5; Power: 115 or 230 v \pm 10%, 60 cps, 55 watts. Dimensions: Cabinet, 7 1/2" wide, 11 1/4" high, 12 1/2" deep; rack mount, 19" wide, 7" high, 11" deep behind panel. Weight: Net 13 lbs. Shipping 19 lbs. (cabinet); Net 17 lbs. Shipping. 26 lbs. (rack mount). Accessories Available: Plug-in Filters (specify frequency): 415B-42B (315-700 cps), \$60; 415B-42C (700 to 2020 cps), \$50. hp 10503A Video Cable Assembly, \$650; hp 10501A Cable Assembly, \$350. Price: hp 415B, \$225 (cabinet); hp 415BR, \$230 (rack mount).

hp 476A, 485A,B DETECTOR MOUNTS

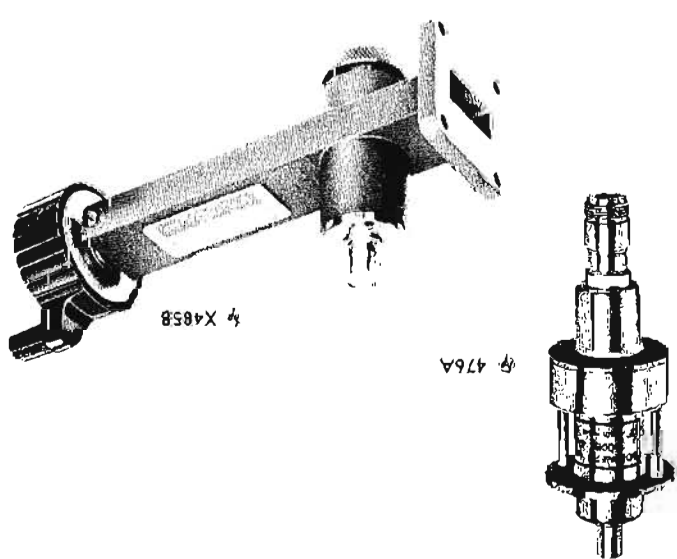

hp 476A Bolometer Mount

Model 476A Bolometer Mount covers the 10 mc to 1000 mc frequency range with very low standing wave ratio. The inherently good square law characteristics of the bolometers used make the 476A especially useful for calibrating attenuators when used with an hp 415 series meter.

Specifications @ 476A

Nominal Impedance: 50 ohms. Maximum SWR: Less than 1.15, 20 to 500 mc; Less than 1.25, 10 to 1000 mc. Maximum Power: 10 mw. Bolometer Element: Four 8.25 ma instrument fuses (supplied with mount); operating level, approximately 200 ohms, positive temperature coefficient. Replacement Element: hp Part #2110-0024, 51 each. Weight: Net 1 lb. Shipping 2 lbs. Price: \$85.

hp 485A,B Detector Mount

These detector mounts permit the accurate matching of waveguide sections to a bolometer element. Model 485A (2.6 to 3.95 gc) uses an 821 series barretter and requires no tuning. The 485B series (3.95 to 12.4 gc) are tuned by a variable short. They may be used with barretter, or, where SWR is not critical, with a silicon crystal.

Specifications @ 485A,B

Model	Maximum SWR	Frequency Range (gc)	Fits Waveguide Size (in.)	Length (in.)	Price
485A	1.35	2.60 - 3.95	3 x 1.5	4-11/16	\$185
485B	1.25	3.95 - 5.85	2 x 1	9-5/16	\$100
	1.25	5.85 - 8.20			
	1.50	8.20 - 5.85			
	1.50	5.30 - 5.50			
485B	1.25	7.05 - 10.0	1.25 x 0.625	6 3/4	\$ 85
X485B	1.25	8.20 - 12.40	1 x 0.5	6	\$ 75

Detector elements are not supplied.

*With 821 series barretter.

821 series barretter only. May use 1N21 or 1N23 for maximum detection sensitivity where SWR is not critical.

Data subject to change without notice.

hp 416B RATIO METER

Ease and Accuracy for Reflection Coefficient Measurements

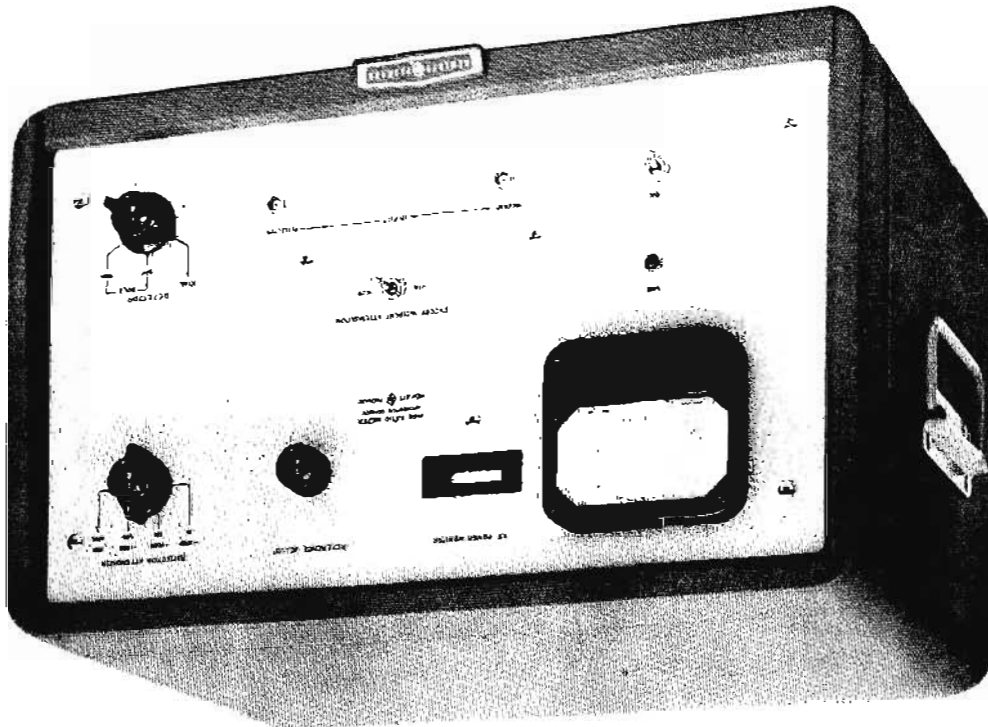

NEW IN THIS CATALOG

Advantages:

- Makes waveguide reflection coefficient measurements practical
- Allows continuous swept-frequency oscilloscope presentation
- Eliminates amplitude-variation error
- Operates accurately over 20/1 incident power level range
- Simplifies reflectometer setups for faster production checks, wide band system alignment and laboratory investigation

Uses:

- Fast reflection coefficient measurements over broad frequency range
- SWR measurement independent of rf power level

Swept frequency reflection coefficient measurements with a reflectometer setup are recognized as an ideal method of evaluating waveguide system performance. The reflectometer setup can save engineering time by eliminating tedious swr measurements with slotted lines, and when driven by a swept oscillator (such as hp 682C-687C Electronic Sweep Oscillator), pages 228, 229), such setups make possible direct and continuous oscilloscope presentation of reflection coefficient over a wide frequency range. A simple change in setup permits using the hp 416B in a swept frequency system to measure attenuation (see pages 164-167).

The hp 416B automatically combines forward and reverse signals and displays their ratio directly, irrespective of amplitude variations.

Specifications

- Meter Presentation:** Reflection coefficient (per cent reflection): four ranges, 100%, 30%, 10% and 3% reflection, equivalent to reflection coefficients of 1, 0.3, 0.1 and 0.03.
- Equivalent SWR:** Two ranges, 1.05 to 1.22 and 1.2 to 1.9.
- DB:** For use with both reflection coefficient and equivalent swr scales. Scale calibrated 0 to -10 db; with ranging, spans 0 to -40 db in four 10 db steps.
- Accuracy:** Crystal, $\pm 3\%$ of full scale. Bolometer, same as crystal except $\pm 5\%$ for incident signal below 1 mv.
- Tuned Frequency:** 1000 cps ± 40 cps.
- Input Voltage (for full-scale deflection):** Bolometer
 Reflected channel: 3 mv to 100 mv rms 0.3 μ v to 10 mv rms
 Incident channel: 3 μ v to 100 mv rms 0.3 μ v to 10 mv rms
- Input Impedance Both Channels:** Crystal, approximately 75K. Bolometer, approximately 5K.
- Excess Incident Attenuation:** Provision for 10 db increase of incident channel sensitivity for reflectometers using couplers with different coefficients. Under certain circumstances, accuracy can be improved by this procedure.
- Output:** Open circuit voltage: Approximately 10 v dc at full scale. Source impedance: 100K. Bolometer: High range, 8.7 ma; low range, 4.3 ma. Bias variable approximately 10% by means of rear panel control. Positive bolometer protection.
- RF Power Monitor:** Level indicator monitors input amplitude (and frequency, indirectly) to assure proper operating range for the instrument and for crystal detectors.
- Power:** 115 or 230 volts $\pm 10\%$, 50 to 60 cps, 115 watts.
- Dimensions:** 20 3/4" wide, 12 3/4" high, 14 1/8" deep (cabinet); 19" wide, 10 1/2" high, 14" deep behind panel (rack mount).
- Weight:** Net 36 lbs. Shipping 47 lbs. (cabinet); Net 28 lbs. Shipping 41 lbs. (rack mount).
- Accessories Available:** hp 10503A, 4 Cable, BNC connectors, \$6.50. hp 11001A, 45" Cable, BNC to dual banana plug, \$5.50. Price: \$590. (cabinet); \$575. (rack mount).

Data subject to change without notice.

The Hewlett-Packard crystal detectors are specified for sensitivity, square law response and input SWR. They also cover stated frequency ranges without tuning. Thus, they are ideal for use in broadband systems such as reflectometers. Each detector where square law response is stated has an individually selected video load resistor for best response characteristics. Therefore, these units should always be operated into a high impedance load for specified square law response. For reflectometers or other applications they are available as matched pairs with tighter specifications on frequency response.

The 485D Series Detector Mounts are broadband units covering full waveguide frequency ranges without requiring any tuning. These mounts use 821 Series Barrettes as detectors. Since barrettes are very closely controlled in manufacturing processes, they do not require frequency response matching to obtain pairs as is necessary with crystal detectors. These barrette mounts are also useful for attenuation measurements in conjunction with hp 415 SWR Meters.

Specifications

Reflectometer Crystal Detectors

Model	Frequency Range	Maximum SWR	Typical Sensitivity	Square Law Characteristic	Matched Pair Available	RF Input	Price
420A	10 mc to 12.4 gc	3	0.1 v dc/mw cw	± 3 db	No	Type N Male	\$50
420B	1 to 4 gc	3	0.05 v dc/mw cw	± 3 db	Yes	Waveguide	\$75
421A	7.05 to 10 gc	1.5	0.05 v dc/mw cw	± 2 db	Yes	Waveguide	\$95
421A	8.2 to 12.4 gc	1.5	0.05 v dc/mw cw	± 2 db	Yes	Waveguide	\$75
M421A	10 to 15 gc	1.5	0.05 v dc/mw cw	± 2 db	Yes	Waveguide	\$175
M421A	12.4 to 18 gc	1.5	0.05 v dc/mw cw	± 2 db	Yes	Waveguide	\$150
P421A	18 to 26.5 gc	2.5	0.1 v dc/mw cw	± 2 db	Yes	Waveguide	\$200
K422A	26.5 to 40 gc	3	0.1 v dc/mw cw	± 2 db	Yes	Waveguide	\$200
R422A							

Read on a meter, such as one of the hp 415 or 416 series, which is calibrated for square-law detectors. When ordered as a matched pair frequency response characteristics track within ± 2 db for power levels less than approximately 0.1 mw; specify Option 01, add \$20 per pair. When ordered as a matched pair frequency response characteristics track within ± 1 db for power levels less than approximately 0.1 mw; specify Option 01, add \$40 per pair. Circular Flange Adapter: K-band (UG-425/U) hp 1151A, \$35 each; R-band (UG-381/U) hp 1151A, \$40 each.



420A (420B identical)

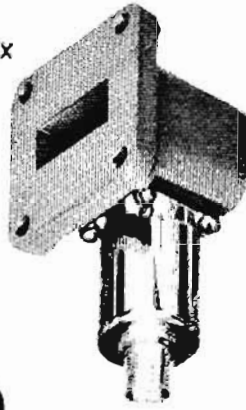

X421A

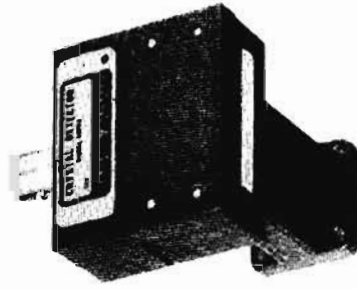

K422A

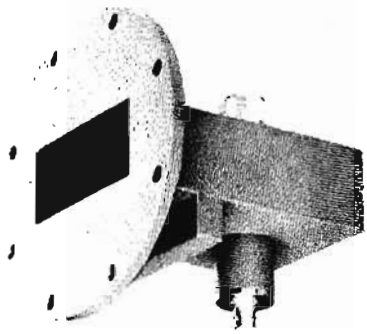

S485D

Specifications
Reflectometer Barretter Mounts

Frequency Range (gc): 2.6 to 3.95, 3.95 to 6.85, 6.3 to 8.2, 3" x 1-1/2", 2" x 1", 1-1/2" x 3/4", 1.5"

Waveguide Size: 3" x 1-1/2", 2" x 1", 1-1/2" x 3/4", 1.5"

SWR (maximum): 1.5, 1.5, 1.5

Frequency Response (maximum variation over full range): < ± 1 db, < ± 1 db, < ± 1 db

Square-Law Characteristic (maximum variation over 40 db range, maximum input power less than 1 mw): ± 0.5 db, ± 0.5 db, ± 0.5 db

Price: \$200, \$170, \$170

† Over frequency range 5.3 to 7.5 gc. Increases to approximately 2 at 8.2 gc.

At frequencies from dc through the audio range, voltage and current are the basic measurement parameters. Instruments for measuring current and voltage at these lower frequencies are readily available. In the micro-wave region, however, instruments for measuring voltage and current are not available. Even if they were, knowledge of voltage and current values would be of less significance because microwave energy is commonly transmitted by electromagnetic waves in a waveguide. Because current and voltage do not exist in the conventional form, power becomes the basic measurement parameter. Furthermore, in a microwave transmission line both voltage and current, although defined, vary with position of measurement because of the distributed nature of the line. Power is constant regardless of position and is therefore a more valuable parameter.

Two basic processes, bolometric and calorimetric, are used to measure microwave power. Both of these techniques are based on the principle that a lossy or resistive material placed in the transmission line can be made to absorb all of the microwave energy being transmitted. Then, by making suitable thermodynamic measurements on the lossy or resistive material, the microwave power can be determined. In the power range up to 10 milliwatts, power measurement devices are made with bolometric techniques. Bolometers (temperature sensitive elements) convert rf power to heat. The heat generated varies the resistance of the bolometric element in proportion to its temperature change. By placing the bolometer in a bridge configuration, the change in resistance can be accurately determined. A number of different techniques are used for determining the resistance change of the bolometer and relating this change to rf power.

Calorimetric techniques are generally used for measuring power in the range above 10 milliwatts, although bolometric measurements are also common where attenuators can be used to drop the power level. There are two basic types of calorimeters—fluid and dry. In fluid calorimeters, a moving stream of fluid is heated by a microwave power. As with bolometric techniques, the actual power is determined by thermodynamic measurement. In dry calorimeters, a static thermal body is used rather than a moving fluid stream.

Two general types of bolometers—barretters and thermistors—are used. Barretters are metallic wire or film in which the temperature coefficient of resistance is positive. Thermistors are semiconductor material in which the temperature coefficient is negative. The Williamson wire barretter, commonly used today for measuring power at millimeter wavelengths, consists of a short length of very fine platinum wire suitably encapsulated. It is very delicate and can easily be burned out by too much power or by switching transients. Wollaston barretters have short time constants which generally make them unsuitable for pulsed rf power measurements.

Thermistors are the most popular bolometric power measurement devices today. They consist of a small bit of semiconductor material suspended between two fine wires. Because of their higher temperature coefficient and mass, they are more rugged than barretters, as increasing power is applied. Thermistors mismatch rapidly when overloaded, reflecting the rf power. Under severe overload conditions, however, their characteristics may change. Either barretters or thermistors may be used with power meters such as the Hewlett-Packard Model 430C. Typical design centers used today are either 100 or 200 ohms, depending on the transmission line configuration. The Model 430C power meter provides

POWER MEASUREMENT

Broadband bolometer mounts are valuable in both coaxial and waveguide configurations to enable instruments such as the Hewlett-Packard 430C to measure power from 10 mc to 40 gc. Tuning is not required, and an extremely low swr is maintained throughout all frequency bands. A single bridge such as used in the 430C Power Meter, with a single thermistor in the bolometer mount, cannot differentiate between changes of microwave power and changes of temperature.

When power is applied to the bolometer element, the amplitude of oscillation decreases by the amount necessary to maintain the element resistance constant. The decrease in audio power is equal to the amount of rf power applied, and it can be read on the voltmeter which is calibrated in terms of microwave power. Broadband bolometer mounts are valuable in both coaxial and waveguide configurations to enable instruments such as the Hewlett-Packard 430C to measure power from 10 mc to 40 gc. Tuning is not required, and an extremely low swr is maintained throughout all frequency bands. A single bridge such as used in the 430C Power Meter, with a single thermistor in the bolometer mount, cannot differentiate between changes of microwave power and changes of temperature.

Two general types of bolometers—barretters and thermistors—are used. Barretters are metallic wire or film in which the temperature coefficient of resistance is positive. Thermistors are semiconductor material in which the temperature coefficient is negative. The Williamson wire barretter, commonly used today for measuring power at millimeter wavelengths, consists of a short length of very fine platinum wire suitably encapsulated. It is very delicate and can easily be burned out by too much power or by switching transients. Wollaston barretters have short time constants which generally make them unsuitable for pulsed rf power measurements.

POWER MEASUREMENT



Figure 1. Basic circuit of power meter.

The 430C circuitry includes a self-balancing bridge and an audio voltmeter to indicate the magnitude of the bridge amplifier output (Figure 1). The external bolometer element is connected as one of the arms of the self-balancing bridge. A high-gain am-

Fluid type calorimeters, such as the Hewlett-Packard Model 434A are widely used to measure average power to 10 watts. The 434A operates from dc to 12.4 gc and measures power by simply connecting the power source to the meter input. The nominal accuracy rating of 5%, which includes all sources of error except mismatch, can be improved by using techniques to minimize mismatch error. Model 872A Coaxial Slide Screw Tuner was designed for use with the 434A Calorimetric Power Meter in the frequency range from 500 mc to 4 gc. Because of the low insertion loss of the 872A, mismatch errors can be eliminated from power measurements made in this frequency range with negligible tuner loss. Measurement accuracy can also be increased by dc substitution, using the hp K02-434A DC Test Set. Calibration points range from 2 mw to 10 w in a 2, 3, 6, 10 sequence.

Directional couplers can be used in any transmission line to permit measurement of higher values of power with either bolometric or calorimetric techniques. High directivity Hewlett-Packard Directional Couplers help eliminate errors which might be caused by reflections in a system. Both waveguide and coaxial couplers are available for making measurements in all bands between 200 mc and 40 gc.

Calorimeters

Figure 2. Simplified diagram, hp 434A Calorimetric Power Meter.

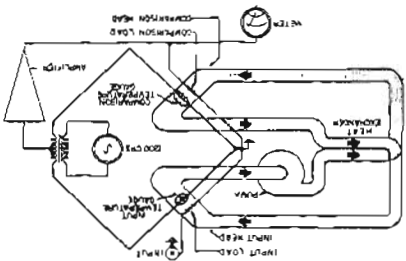

rated within the bolometer unit and thus does not include mismatch.

current, variable in decade steps, for delivering known amounts of power to the thermistor used for rf measurement with the 431B meter. Typical accuracy of 0.5% is achieved when using the 8402A calibrator to eliminate the effects of bridge errors.

Sources of Error

In addition to the bridge error discussed above, power measurements can be affected by mismatch and by efficiency of the thermistor mount.

Mismatch error occurs when power is reflected rather than absorbed by the thermistor mount. Mismatch error can be eliminated or minimized by using a tuner with the mount to provide a more perfect match. When a tuner is used, its insertion loss must be considered. In the normal situation, the greater accuracy obtained by cancelling out the reflection more than compensates for the insertion loss of the tuner.

The term *efficiency* includes two types of losses in the thermistor mount. First, there is a dc substitution error caused by skin effect of the thermistor element which causes the thermistor resistance to change when dc or rf power is applied. Rf energy tends to flow only on the surface of the thermistor while dc penetrates throughout the thermistor bead. The second type of loss, often called mount efficiency, is caused by the transmission line and thermistor mounting structure. Separation of these two types of losses is virtually impossible.

Mismatch and efficiency errors are frequently called (1) calibration factor and (2) effective efficiency. The National Bureau of Standards defines calibration factor as the ratio of dc substituted power in the bolometer mount to rf power incident on the bolometer input connector. Therefore, any reflected power caused by mismatch is taken into account. Effective efficiency is defined by NBS as the ratio of the substituted dc power in the bolometer mount to the microwave power dissipated to the microwave power

changes in ambient temperature result in drift and potentially erroneous readings. The problem is magnified when measuring extremely low values of microwave power.

The use of two self-balancing bridges, as in the Hewlett-Packard Model 431B Power Meter, helps eliminate the problems of drift caused by temperature change. Mounts for use with the 431B have two thermistors, one for each of the bridges in the meter. One thermistor and bridge senses and measures the rf power; the other thermistor and bridge senses ambient temperature changes and automatically corrects the meter reading to compensate for such changes. Typically, drift due to varying ambient temperature is reduced by a factor of 100.

The improved stability of the 431B eliminates the need for continuous zero settings under normal conditions and also provides an additional 10 db sensitivity over other types of meters. Full scale readings as low as 10 microwatts can be made.

Models 478A (coaxial) and 486A (waveguide) thermistor mounts have been designed for use with the Hewlett-Packard Model 431B Power Meter. They provide the thermal matching necessary for accurate low level measurements.

DC power can also be applied to the rf measuring thermistor used with the 431B Power Meter. Thus, to make more accurate power measurements, or to calibrate the instrument, a known amount of dc power can be placed across the thermistor and the meter reading on the 431B noted. This technique is basically the same as the dc substitution method used by standards laboratories. By comparing dc power, which can be very accurately determined, to rf power, the accuracy of the power bridge is completely removed from the measurement.

The Hewlett-Packard Model 8402A Power Meter Calibrator is used to facilitate calibration of the 431B Power Meter. The 8402A provides a constant

hp 430C MICROWAVE POWER METER
 hp 477B, 487 Thermistor Mounts

The hp 430C reads rf power directly in dbm or mw—and completely eliminates tedious computation and troublesome adjustments during operation. The instrument may be used at any frequency for which there are bolometer mounts—and measurements are entirely automatic.

In measuring power, hp 430C uses a bolometer at either 100- or 200-ohm levels. Power is read direct in milliwatts, 0.01 to 10 mw, or in dbm from -20 to +10. Higher powers may be measured by adding attenuators to the system. Directional couplers may also be used to sample energy.

When used in an appropriate bolometer mount, instrument fuses are generally satisfactory for measuring power at frequencies up to 4 gc. Barretters and thermistors can be used for measurements at much higher frequencies; up to 12.4 gc for barretters (in hp mounts) and up to 40 gc for certain thermistors.

Hewlett-Packard waveguide bolometer mounts for the 430C are available covering, collectively, the frequency spectrum from 2.6 to 40 gc. In addition, Model 477B Thermistor Mount covers the frequency spectrum from 10 mc to 10 gc.

External Bolometer: Frequency range depends on bolometer mount. Bolometers can operate at resistance levels of 100 or 200 ohms and can have positive or negative temperature coefficients. Any dc bias current up to 16 ma is available for biasing bolometers. DC bias current is continuously adjustable and independent of bolometer resistance and power level range.

Accuracy: ± 5% of full scale.

Power: 115 or 230 v ± 10%, 50 to 1,000 cps, 90 watts.

Dimensions: Cabinet: 7 1/2" wide, 11 1/2" high, 14 1/4" deep. Rack Mount: 19" wide, 7" high, 13 1/8" deep behind panel.

Weight: Net 14 lbs. Shipping 19 lbs. (cabinet). Net 18 lbs. Shipping 30 lbs. (rack mount).

Price: hp 430C, \$250 (cabinet); hp 430CR, \$255 (rack mount).

Specifications hp 430C

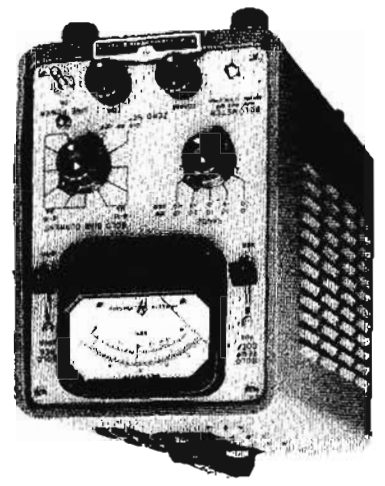

hp 430C

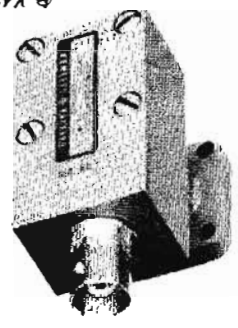

hp 487B



hp 477B

Specifications

Model	Maximum Power	Frequency Range	Price
S487B	1.35	2.60 - 3.95	\$105
G487B	1.5	3.95 - 5.85	\$ 95
J487B	1.5	5.3 - 8.2	\$ 90
H487B	1.5	7.05 - 10.0	\$ 80
X487B	1.5	8.2 - 12.4	\$ 75
M487B	1.5	10.0 - 15.0	\$110
P487B	1.5	12.4 - 18.0	\$110
K487C*	2.0	18.0 - 26.5	\$225
R487B*	2.0	26.5 - 40.0	\$275

*Circular range adapters: K-Band (UG-425/U) hp 11515A, \$35 each. R-Band (UG-381/U) hp 11516A, \$40 each.

Data subject to change without notice.

hp 487 Waveguide Thermistor Mounts

This coaxial thermistor mount, designed for use in 50-ohm systems with the hp 430C, covers 10 mc to 10 gc with an SWR of less than 1.5. It requires no tuning and employs long-time constant elements that assure measurement accuracy—even for low duty cycle pulses. In addition, it is not susceptible to burnout even at power levels as high as 1 watt.

Specifications

Frequency Range: 10 mc to 10 gc.
 SWR: Less than 1.5 (less than 1.3, 50 mc to 7 gc).
 Power Range: 0.01 to 10 mw (with hp 430C).
 Element: 200-ohm, negative temperature coefficient thermistor included. Approx. 13 ma bias required.
 RF Connector: Type N male.
 Price: hp 477B, \$75.

hp H01-8401A LEVELER AMPLIFIER, hp 8402A POWER METER CALIBRATOR

hp 8402A Power Meter Calibrator

Full-scale calibration and meter tracking of hp Models 431A and 431B (see Page 198) can be verified with the Model 8402A Power Meter Calibrator, which also can be used with a precision voltmeter to measure operating resistance of a resistor mount and thereby permit more accurate power measurements.

The 8402A is a constant current power supply which furnishes an accurately known dc current to the power-sensing thermistor. For full-scale calibration of the 431A,B Meters, the dc current is within $\pm 0.1\%$ of the value calculated for the nominal operating resistance of the thermistor. Accuracy of the substituted dc power is typically within $\pm 0.5\%$.

The 8402A, in conjunction with a precision dc voltmeter and a 431A or B, can measure rf power by the dc substitution method. Simple equations permit easy and accurate calculation of the dc substitution power, which is within $(0.5\% \pm 0.1 \mu\text{watt})$ of the calculated value if the dc voltmeter is accurate within 0.1% .

Specifications

Calibration Function:
Full Scale Values: 0.01, 0.03, 0.1, 0.3, 1, 3, and 10 mw, corresponding to full scale range of 431A,B Power Meters.
Meter Tracking: 10, 8, 6, 4, and 2 mw.
Accuracy: $\pm 0.1\%$ of calculated current; $\pm 0.5\%$ dc substituted power $\pm 0.3 \mu\text{watts}$.
DC Substitution Range: Current variable over range compatible with measurements from 1 μw to 10 mw. (Precision dc voltmeter required).
Thermistor Operating Resistance: Range: 100 ohms or 200 ohms, nominal.
Accuracy: Typically $\pm 0.2\%$ using a dc voltmeter with 1% accuracy.
Dimensions: 6" high, 7.25/32" wide, 12 1/2" deep.
Weight: Net 8 lbs. Shipping 13 lbs.
Power: 115 or 230 v $\pm 10\%$, 50 to 1000 cps, 2 1/2 watts.
Price: \$475.

Data subject to change without notice.

This special Hewlett-Packard instrument provides a closed-loop control system for maintaining constant output power from hp electronic sweep oscillators and microwave amplifiers. Both the large scale change of output power with frequency and the smaller, more rapid, fine grain structure, common to BWO and IWT devices are greatly reduced.

The H01-8401A is used with an hp 431A,B Power Meters,* a thermistor mount and a directional coupler to provide a compensating signal should the controlled instrument tend to vary its output. The 431A,B and H01-8401A together allow a calibrated control of output power over a wide range of levels.

Specifications

Input: Accepts 0 to -1 v dc from hp Model 431A,B Power Meters or a negative output crystal detector.
Output: 0 to -27 v dc into 20K minimum impedance for direct connection to amplitude modulation input of hp electronic sweep oscillators (682C, 683C, 684C, H01-686C, 686C and 687C) and microwave amplifiers (489A, 491C, 493A and 495A).
Response: Switch controlled at the input for operation with the hp Model 431A,B Power Meters or a crystal detector.
Leveling: The leveling ability of the leveler amplifier and 431 Power Meter combination is governed by the rate of variations of output amplitude of the individual sweep oscillator or microwave amplifier. Typically, for full band sweeping, leveled power is constant with ± 0.2 db (plus coupler variation) on the 3 slowest sweep ranges of the hp sweep oscillators.
The leveling capability of the leveler amplifier and rf response binomial is largely determined by coupler variation and rf response of the crystal. Within the hp series 680 sweep oscillators, satisfactory leveling at all but the fastest sweep rates is possible.
Marker Output: Video pip available when reaction wavemeter is inserted in rf portion of leveling loop.
Modulation Input: Permits 400 cps to 10 kc external square wave modulation of sweep oscillators and microwave amplifiers.
Connectors: BNC.
Dimensions: 6 1/2" high, 7.25/32" wide, 12" deep.
Weight: Net 6 lbs. Shipping 8 lbs.
Power Requirements: 115 or 230 v $\pm 10\%$, 50 to 1000 cps, 1 1/2 watts approx.
Accessories Furnished: 7 1/2 foot detachable power cable, 8401A-16 cable 4 ft. long.
Price: \$200.
* A slight modification of the 431A's circuitry permits its use with the hp H01-8401A.

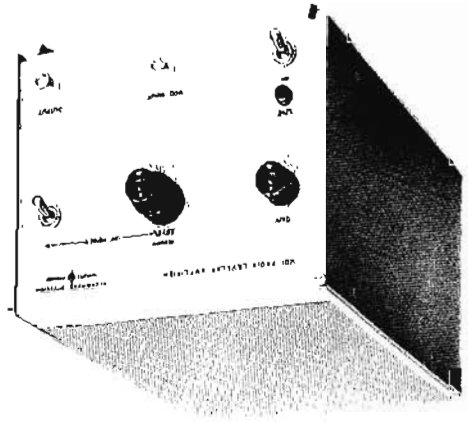
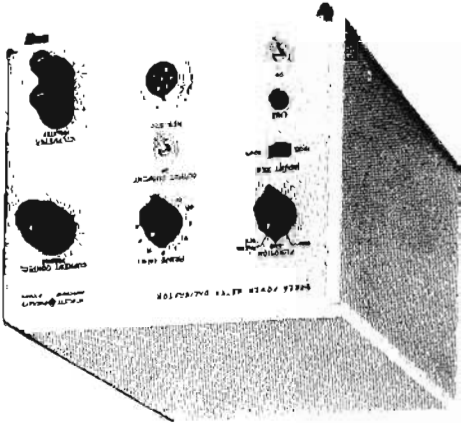

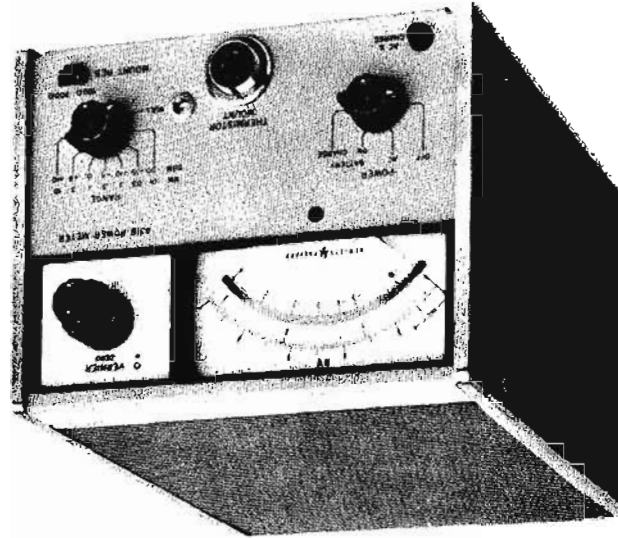

NEW IN THIS
CATALOG

431B POWER METER

Power Measurements 1 μ w to 10 mw

Advantages:

Extremely low drift

$\pm 3\%$ accuracy on all ranges, even greater accuracy

using simple external calibration procedures

One zero setting for all ranges

Extremely easy to operate

Grounded recorder output

Portable operation (with optional battery pack)

Uses:

Instantaneous microwave power measurements with

higher accuracy

Microwave standards measurements

Continual zero-setting is a thing of the past... even on the 10 μ w range, with the 431B Power Meter. Extremely high stability means that in typical laboratory environments one zero setting will hold for hours. In addition, only one zero adjustment is needed to calibrate the 431B for all ranges! Even in less favorable environments only occasional adjustment is necessary.

The extreme temperature stability of this instrument makes possible (and usable) an additional sensitivity of 10 db over previously available equipment. Full scale readings of 10 μ w to 10 mw are covered in 7 ranges. The meter face is also calibrated in dbm with 5 db between ranges. Direct-reading accuracy is $\pm 3\%$ of full scale.

Temperature-compensated thermistor mounts are required for operation with the 431B. The 478A Coaxial Mount covers 10 MC to 10 GC and the 486A Waveguide Mounts span 2.6 to 40 GC.

Microwave standards measurements can be made to high accuracy and resolution with the Model 431B by using the instrument as a transfer device. A dc calibration input jack permits precise dc substitution power measurements. The grounded output jack will then drive an appropriate digital voltmeter for increased resolution.

The 431B also has an optional rechargeable battery pack which will give up to 24 hours of completely portable

431B

operation. A front panel control selects ac operation with trickle-charge, battery operation, or battery charge alone.

Circuit Description

Two balanced bridges are employed in the Φ 431B. One arm of each is a temperature-sensitive element. The thermistor units are in close thermal proximity in the dual mount. One thermistor and bridge senses the rf power. The other thermistor and bridge senses only the ambient temperature conditions and corrects for zero drift. Both bridges are continuously maintained in a balanced condition so both thermistors for elements have similar heat transfer characteristics at all times.

This unique circuit approach gives a self-balancing device for both rf power and temperature changes, with all critical components located within a feedback loop. If thermistors and mounts were available that tracked identically with temperature, no zero setting would ever be necessary. The new Φ 478A and 486A dual thermistor mounts use extremely high heat-conductivity metals and selected thermistors for exceedingly close tracking, even in the presence of thermal shocks.

Specifications

Φ 431B

Power Range: 7 ranges. Full scale readings from 10 μ w to 10 mw. Also calibrated in dbm from -30 dbm to +10 dbm. **Accuracy:** \pm 3% of full scale on all ranges from 20° to 35° C; \pm 5% from 0° to 55° C. **Zero Carry-Over:** Less than 1% of full scale when zeroed on most sensitive range.

Operating Impedance: 100 or 200 ohms, negative, for operation with Φ 478A, 486A. **Recorder/Voltmeter Output:** Phone jack on rear with 1 ma maximum into 1,000 ohms \pm 10%.

Calibration Input: Binding posts on rear for calibration of bridge with precise dc standards.

Power: 2 1/2 watts, 115 or 230 v \pm 10%, 50 to 1,000 cps. **Dimensions:** 7-25/32" wide, 63/8" high, 1 1/2" deep. **Weight:** Net, 8 lbs. Shipping, 13 lbs.

Accessories Furnished: 5-foot interconnection cord for Φ temperature-compensated thermistor mounts.

Accessories Available: Rechargeable battery pack for field installation, Φ 431B-95A \$100.

Price: Φ 431B, \$425.

Option 01: Rechargeable battery installed, add \$100.

Φ 478A AND 486A THERMISTOR MOUNTS

These thermistor mounts are designed for the temperature-compensated Φ Model 431B Power Meter. Each mount contains a pair of negative coefficient thermistor sets in similar thermal environments. One thermistor set responds to the rf input and ambient temperature; the other responds only to ambient temperature and compensates for temperature changes. Extremely close tracking is achieved, even with the application of thermal shocks. Hence the instruments are remarkably free from drift and conveniently measure power as low as one microwatt. Furthermore, dc calibration power may be applied and a dc digital voltmeter used to read out

from the Φ Model 431B Power Meter. Such a procedure permits accurate, high-resolution, transfer-power measurements in standards systems.

Model 478A Thermistor Mount is designed for 50-ohm coaxial systems which operate from 10 mc to 10 gc. The rf thermistor pair presents a good match to 50-ohm systems over its full frequency range. No tuning is required.

Model 486A Thermistor Mounts are designed for 2.6 to 40 gc waveguide systems. Each mount provides a good match over its waveguide range and no tuning is required.

Specifications

Φ 478A and Φ 486A

Model	Frequency	Maximum SWR	Operating Resistance	Price
478A	10 mc to 10 gc	1.6, 10-25 mc-7 gc	200 ohms	\$145
		1.3, 25 mc-7 gc		
		1.5, 7-10 gc		

5486A	2.6 to 3.95 gc	1.35	100 ohms	\$195
G486A	3.95 to 5.85 gc	1.5	100 ohms	\$180
J486A	5.3 to 8.2 gc	1.5	100 ohms	\$170
H486A	7.05 to 10.0 gc	1.5	100 ohms	\$165
X486A	8.2 to 12.4 gc	1.5	100 ohms	\$145
M486A	10.0 to 15.0 gc	1.5	100 ohms	\$195
P486A	12.4 to 18.0 gc	1.5	100 ohms	\$195
K486A*	18.0 to 26.5 gc	2.0	200 ohms	\$300
R486A*	26.5 to 40.0 gc	2.0	200 ohms	\$375

*Circular Range adapters: K-band (UG-425/U) Φ 11515A, \$35 each. R-band (UG-381/U) Φ 11516A, \$40 each.

For All Models

Power Range: 1 μ w to 10 mw.

Elements: Permanently installed thermistor.

Bridge Connector: Mates with 431B cable.

Shipping Weight: 1 lb, except 5486A, 3 lbs.; G486A, 2 lbs.

Data subject to change without notice.

Φ X486A

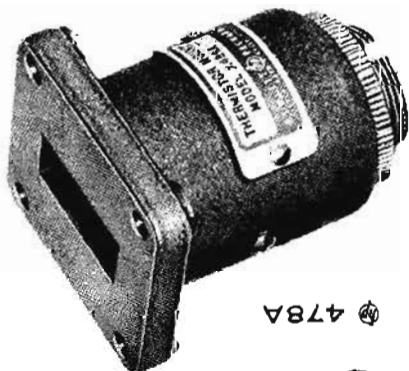

Φ 478A



Model 434A employs a self-balancing bridge and a high-efficiency heat transfer system to and from an oil stream to

Rapid Response Time

Model 434A fills the important range between bolometer-type microwave power meters such as 431B (pages 198, 199) and conventional calorimeters whose lower range is approximately 10 watts. But unlike previous cumbersome and costly equipment suggested for its range, the 434A is completely self-contained and requires no external detectors. In addition, the wider frequency response permits the unit to be conveniently calibrated by the application of a known dc power.

With the 434A, measurement is literally as simple as connecting to a 50 ohm type N front panel terminal and reading power directly. The instrument has only two simple front panel controls, and is ideal for use by non-technical personnel. Model 434A, measurement is literally as simple as connecting to a 50 ohm type N front panel terminal and reading power directly. The instrument has only two simple front panel controls, and is ideal for use by non-technical personnel.

Stated simply, the 434A Calorimetric Power Meter offers you this:

The fastest, easiest means yet devised to measure powers accurately from 10 milliwatts to 10 watts between dc and 12.4 gc.

Model 434A, measurement is literally as simple as connecting to a 50 ohm type N front panel terminal and reading power directly. The instrument has only two simple front panel controls, and is ideal for use by non-technical personnel.

Model 434A, measurement is literally as simple as connecting to a 50 ohm type N front panel terminal and reading power directly. The instrument has only two simple front panel controls, and is ideal for use by non-technical personnel.

Model 434A, measurement is literally as simple as connecting to a 50 ohm type N front panel terminal and reading power directly. The instrument has only two simple front panel controls, and is ideal for use by non-technical personnel.

Model 434A, measurement is literally as simple as connecting to a 50 ohm type N front panel terminal and reading power directly. The instrument has only two simple front panel controls, and is ideal for use by non-technical personnel.

Model 434A, measurement is literally as simple as connecting to a 50 ohm type N front panel terminal and reading power directly. The instrument has only two simple front panel controls, and is ideal for use by non-technical personnel.

Model 434A, measurement is literally as simple as connecting to a 50 ohm type N front panel terminal and reading power directly. The instrument has only two simple front panel controls, and is ideal for use by non-technical personnel.

Model 434A, measurement is literally as simple as connecting to a 50 ohm type N front panel terminal and reading power directly. The instrument has only two simple front panel controls, and is ideal for use by non-technical personnel.

Model 434A, measurement is literally as simple as connecting to a 50 ohm type N front panel terminal and reading power directly. The instrument has only two simple front panel controls, and is ideal for use by non-technical personnel.

Model 434A, measurement is literally as simple as connecting to a 50 ohm type N front panel terminal and reading power directly. The instrument has only two simple front panel controls, and is ideal for use by non-technical personnel.

Model 434A, measurement is literally as simple as connecting to a 50 ohm type N front panel terminal and reading power directly. The instrument has only two simple front panel controls, and is ideal for use by non-technical personnel.

Model 434A, measurement is literally as simple as connecting to a 50 ohm type N front panel terminal and reading power directly. The instrument has only two simple front panel controls, and is ideal for use by non-technical personnel.

Model 434A, measurement is literally as simple as connecting to a 50 ohm type N front panel terminal and reading power directly. The instrument has only two simple front panel controls, and is ideal for use by non-technical personnel.

Model 434A, measurement is literally as simple as connecting to a 50 ohm type N front panel terminal and reading power directly. The instrument has only two simple front panel controls, and is ideal for use by non-technical personnel.

- Measures higher powers by means of external directional couplers
- Measures power to 10 watts average, 1 kw peak

- Advantages:**
- Simplest power measurements, 10 mw to 10 watts, dc to 12.4 gc
 - Extremely broad band, dc to 12.4 gc
 - No external terminations or detectors
 - Compact, entirely self-contained
 - Direct reading in watts and DBW

Model 434A, measurement is literally as simple as connecting to a 50 ohm type N front panel terminal and reading power directly. The instrument has only two simple front panel controls, and is ideal for use by non-technical personnel.

Model 434A, measurement is literally as simple as connecting to a 50 ohm type N front panel terminal and reading power directly. The instrument has only two simple front panel controls, and is ideal for use by non-technical personnel.

Model 434A, measurement is literally as simple as connecting to a 50 ohm type N front panel terminal and reading power directly. The instrument has only two simple front panel controls, and is ideal for use by non-technical personnel.

Model 434A, measurement is literally as simple as connecting to a 50 ohm type N front panel terminal and reading power directly. The instrument has only two simple front panel controls, and is ideal for use by non-technical personnel.

Model 434A, measurement is literally as simple as connecting to a 50 ohm type N front panel terminal and reading power directly. The instrument has only two simple front panel controls, and is ideal for use by non-technical personnel.

Model 434A, measurement is literally as simple as connecting to a 50 ohm type N front panel terminal and reading power directly. The instrument has only two simple front panel controls, and is ideal for use by non-technical personnel.

Model 434A, measurement is literally as simple as connecting to a 50 ohm type N front panel terminal and reading power directly. The instrument has only two simple front panel controls, and is ideal for use by non-technical personnel.

Model 434A, measurement is literally as simple as connecting to a 50 ohm type N front panel terminal and reading power directly. The instrument has only two simple front panel controls, and is ideal for use by non-technical personnel.

Model 434A, measurement is literally as simple as connecting to a 50 ohm type N front panel terminal and reading power directly. The instrument has only two simple front panel controls, and is ideal for use by non-technical personnel.

Model 434A, measurement is literally as simple as connecting to a 50 ohm type N front panel terminal and reading power directly. The instrument has only two simple front panel controls, and is ideal for use by non-technical personnel.

Model 434A, measurement is literally as simple as connecting to a 50 ohm type N front panel terminal and reading power directly. The instrument has only two simple front panel controls, and is ideal for use by non-technical personnel.

Model 434A, measurement is literally as simple as connecting to a 50 ohm type N front panel terminal and reading power directly. The instrument has only two simple front panel controls, and is ideal for use by non-technical personnel.

Model 434A, measurement is literally as simple as connecting to a 50 ohm type N front panel terminal and reading power directly. The instrument has only two simple front panel controls, and is ideal for use by non-technical personnel.

Model 434A, measurement is literally as simple as connecting to a 50 ohm type N front panel terminal and reading power directly. The instrument has only two simple front panel controls, and is ideal for use by non-technical personnel.

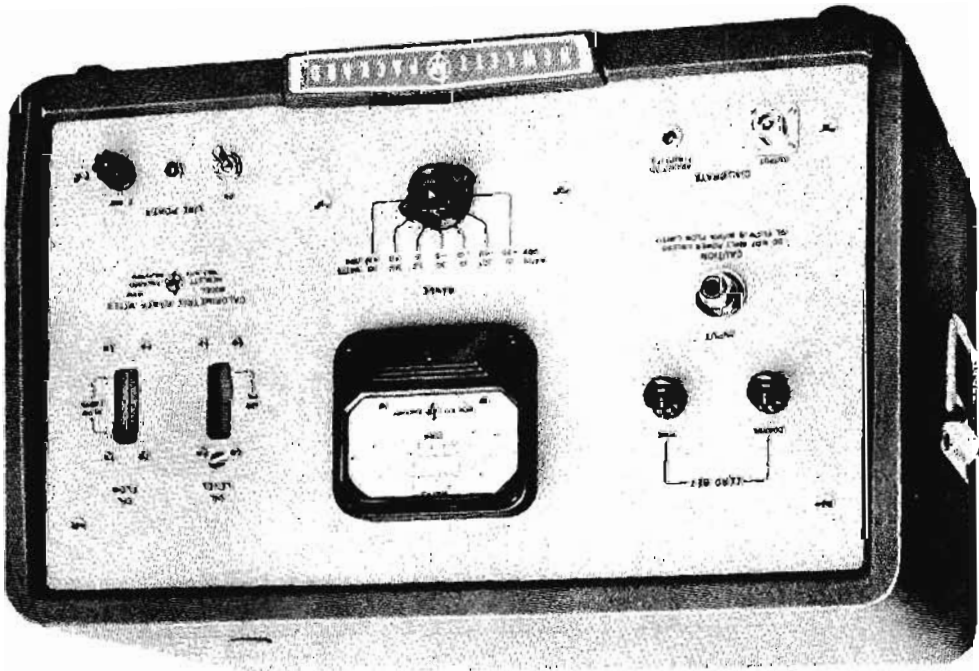

Just Connect, Read Power 10 MW to 10 Watts

HP 434A CALORIMETRIC POWER METER

exchanger just prior to entering the heads. Identical flow rates are obtained by placing all elements of the oil system in series.

Specifications

Input Power Range: Seven meter ranges. Full-scale readings of 0.01, 0.03, 0.1, 0.3, 1.0, 3.0 and 10 watts. Meter scale also calibrated from -10 to 0 DBW, providing continuous readings from -30 to +10 DBW. Power range can be extended upward with attenuators or directional couplers.

Maximum Input Power: 1 kilowatt, peak, 10 watts average. **Frequency Range:** DC to 12.4 gc. **DC Input Impedance:** 50 ohms \pm 5 ohms at type N input jack. **Input SWR:** DC to 5 gc, less than 1.3; 5 to 12.4 gc, less than 1.5. **Meter Response Time:** Less than 5 seconds for full scale deflection.

Internal Calibrator: 100 mw dc \pm 1% into 45 to 55 ohms. **Accuracy:** Within \pm 5% of full scale. Includes dc calibration and rf termination efficiency but not mismatch loss. Greater accuracy can be achieved through appropriate techniques.

Estimated Attainable Accuracy:

DC	Upper Ranges	Lower Ranges
0 to 1 gc	1%	3%
1 to 4 gc	2%	4%
4 to 10 gc	3%	5%
10 to 12.4 gc	4%	5%

Power Supply: 115 or 230 volts \pm 10%, 50 to 60 cycles, approximately 155 watts with no input, 175 watts with 10 watts input.

Dimensions: Cabinet Mount: 20 3/4" wide, 12 3/4" high, 14" deep. Rack Mount: 19" wide, 10 1/2" high, 13 1/2" deep behind panel.

Weight: Net 49 lbs. Shipping 61 lbs. (cabinet mount). Net 44 lbs. Shipping 59 lbs. (rack mount).

Accessories: 281A Waveguide to Coaxial Adapters (See page 179). K02-434A DC Test Set for more accurate power measurements, \$1000.00. See Application Note 38. 8402A Power Meter Calibrator (See page 197).

Price: 434A, \$1,600.00 (cabinet); 434AR, \$1,585.00 (rack mount).

Data subject to change without notice.

provide a full scale response time of 5 seconds or less. This fast reaction, a fraction of the response time needed by ordinary calorimeters, means the 434A quickly follows small power changes, such as may be encountered in tuning.

Circuit Description

Basically the Model 434A consists of a self-balancing bridge which has identical temperature-sensitive resistors (gauges) in two legs, an indicating meter and two load resistors, one for the unknown input power and one for the comparison power. The input load resistor and one gauge are in close thermal proximity so that heat generated in the input load resistor heats the gauge and unbalances the bridge. The unbalance signal is amplified and applied to the comparison load resistor which is in close thermal proximity to the other gauge so that the heat generated in the comparison load resistor is transferred to its gauge and nearly rebalances the bridge.

The meter measures the power supplied to the comparison load to rebalance the bridge. The characteristics of the gauges are the same and the heat transfer characteristics from each load are the same, so the power dissipated in each load is the same, and the meter may be calibrated directly in input power.

The power measurement is accurate because the flow rates through the two heads are the same and the oil enters the heads at nearly the same temperature. To insure constant temperature and to bring the streams to nearly the same temperature, they are passed through a parallel-flow heat

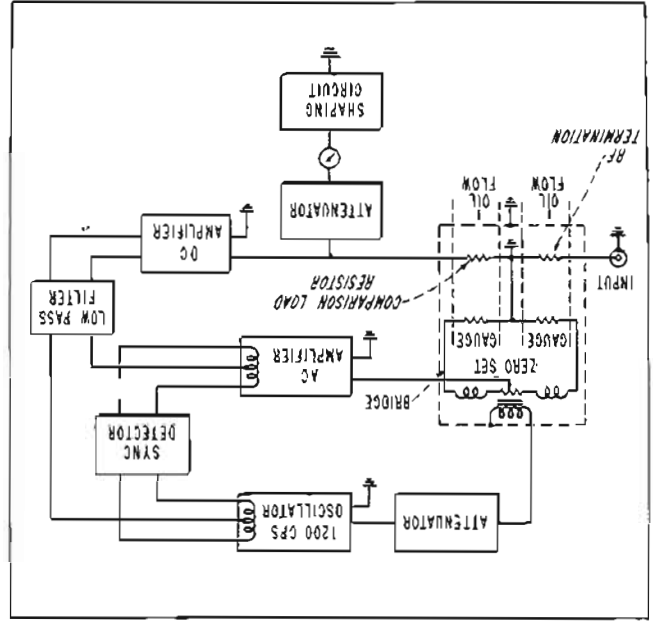

Figure 1. Basic arrangement of instrument circuitry.

489A-495A TRAVELING-WAVE TUBE AMPLIFIERS

Broad Band, High Gain, High Power Amplification, 1 to 12.4 GC

Hewlett-Packard offers two groups of traveling-wave tube amplifiers, one low-power series and another group producing at least 1 watt output for 1 milliwatt input. Both offer a small signal gain of 30 db.

One-Watt TWT Amplifiers

These instruments, covering 1 to 12.4 gc, provide at least one watt output for one milliwatt input over their entire frequency range. Amplitude modulation circuitry has been designed for wide bandwidth (down to dc) and with internal amplification so that small modulation signals cause a large output power change. This unique modulation circuitry also permits power leveling with external elements, plus remote programming. TWT cathode current is monitored by a front panel meter and can be controlled by the Gain adjustment for rated power output, or for reducing tube current to extend tube life when full output power is not required. Helix, collector and anode current can be measured at an easily accessible test point board.

Periodic permanent magnet focusing reduces weight, size and power consumption and at the same time alleviates alignment problems. Protective features incorporated to prevent TWT failure include an overload relay on the helix power supply, a three-minute time delay on the beam supply and a fail-safe circuit that disconnects ac power whenever the regulated filament supply voltage exceeds a predetermined level.

Instruments in the one-watt series include the *hp 489A*, 1 to 2 gc; *hp 491C*, 2 to 4 gc; *hp 493A*, 4 to 8 gc, and *hp 495A*, 7 to 12.4 gc.

Specifications

Frequency Range:	Price (includes encapsulated tube):
489A 1-2 gc	\$2300
493A 2-4 gc	\$2300
495A 4-8 gc	\$2900
495A 7-12.4 gc	\$2900

Output for 1 MW input: At least 1 watt.
 Maximum RF Input: 100 mw.
 Small Signal Gain: Greater than 30 db.
 Amplitude Modulation Passband: DC to 100 kc for 20 db change of rf level, dc to 500 kc for 1 db change.
 Modulation Sensitivity: Approx. 20 db rf change for a 20 v peak input signal.
 Input and Output Impedance: 50 ohms.
 Connectors: Type N female.
 Front Panel Controls: Gain.
 Meter Monitors: Cathode current.
 Power: 115 or 230 v \pm 10%, 50 to 60 cps, approx. 200 watts.
 Dimensions: 16 3/4" wide, 5 1/2" high, 18 3/8" deep. Hardware furnished for conversion to EIA rack mount.
 Weight: Net 40 lbs. Shipping 60 lbs.

Low Power TWT Amplifiers

These standard TWT amplifiers cover the range of 2 to 12.4 gc. Each may be amplitude, pulse, phase or frequency modulated. The units are especially well suited to phase modulation techniques such as employed in Serrordyne and Homodyne systems. Front panel controls include adjustments for TWT helix and grid voltages, and a panel meter and selector switch allow measurement of cathode, anode, helix and collector currents.

The *hp 490B*, 2 to 4 gc, provides at least 10 mw output, 30 db gain with a noise figure less than 25 db. The *hp 492A* and *hp 494A* (7 to 12.4 gc) are low level, high gain instruments with 30 db gain and 20 mw output.

Specifications

Frequency Range:	Maximum Output Power:	Modulated Pulse Delay:	Helix Modulating Voltage:	Hum and Spurious Modulation:	Weight:	Power Supply:	Accessories:	Price (includes encapsulated tube):
<i>hp 494A</i> 7 to 12.4 gc	10 mw minimum into 50-ohm load	Approx. 15 nsec	Approx. 30 v p-p. Provides 360° phase shift; input impedance 100K	At least 40 db below signal level	63 lbs. net	115 volts \pm 10% 50 to 60 cps, approx. 225 w	11500A Cable Assembly	\$2000 (cabinet)
<i>hp 492A</i> 4 to 8 gc	20 mw minimum into 50-ohm load	Approx. 20 nsec	Approx. 40 v p-p. Provides 360° phase shift; input impedance 100K	At least 40 db below signal level	85 lbs. net	115 volts \pm 10% 50 to 60 cps, approx. 200 w	11500A Cable Assembly	\$2000 (cabinet)
<i>hp 490B</i> 2 to 4 gc	10 mw minimum into 50-ohm load	Approx. 35 nsec	Approx. 30 v p-p. Provides 360° phase shift; input impedance 1 meghm	At least 30 db below signal level	55 lbs. net	115 volts \pm 10% 50 to 1000 cps, approx. 135 w	11500A Cable Assembly	\$1500 (cabinet)

Common Specifications

Maximum Small Signal Gain: 30 db minimum.
 Meter Monitors: Cathode, anode, helix and collector current.
 Output Impedance: 50 ohms, swr less than 2.
 Dimensions: Cabinet Mount: 7 3/8" wide, 11 1/2" high, 19 1/2" deep (490B 20" deep).
 Connectors: RF Input and Output: Type N.
 Noise Figures: Less than 30 db (25 db for 490B).
 Pulse Rise and Decay Time: Approximately 15 ns.
 Amplitude Modulating Voltage: A 50 volt positive pulse will produce a 40 db change in rf power output. Sensitivity, approximately 1 db/volt.
 Data subject to change without notice.

Rack mounting instruments are available, price on request.

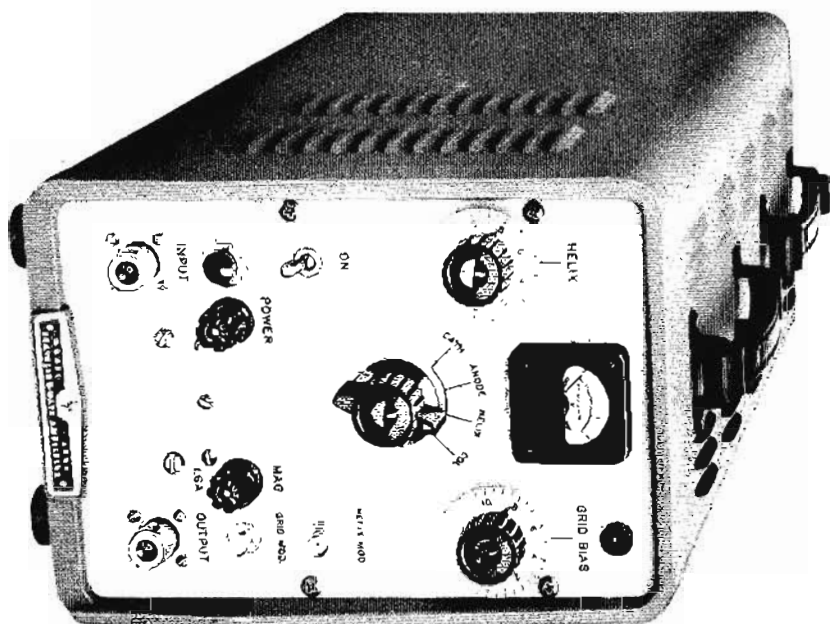

492A

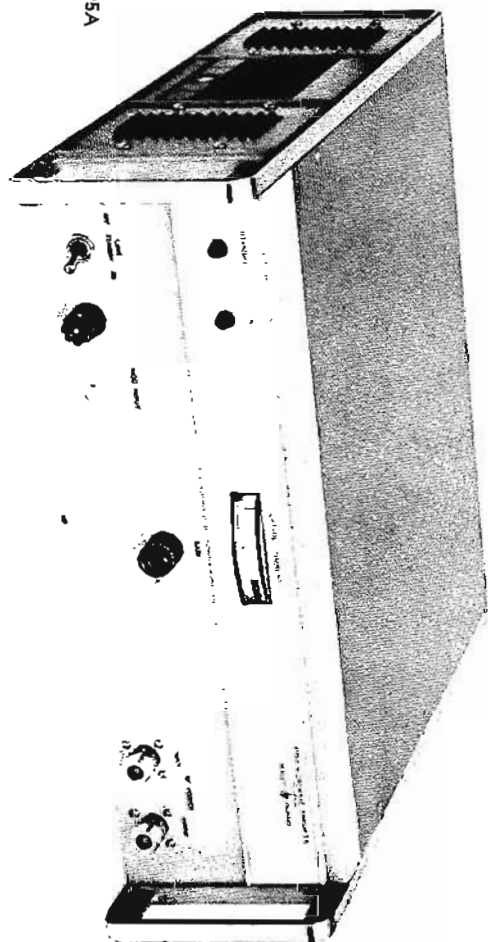

495A

hp 532 SERIES, 536A FREQUENCY METERS

Precision General Purpose Meters for Lab or Production Use

Models 532 Series and 536A Frequency Meters are wide-band, direct reading instruments offering quality construction, convenience and outstanding value. Frequency is read directly in gc with high accuracy, as indicated on the adjoining table. No interpolation or charts are required. The instruments comprise a special transmission section with a high Q resonant cavity that is tuned by a choke plunger. No sliding contacts are used, and the section transmits virtually full power at resonance. A 1 db or greater dip in output indicates resonance. There are no spurious responses. * Tuning is by a precision lead screw, spring-loaded to eliminate backlash. Resolution is enhanced by a long, spiral scale calibrated in small frequency increments. For example, Model X532B has an effective scale length of 71" and is calibrated in 5 mc increments. Resetability is extremely good. All frequency calibrations are visible so you can tell at a glance the specific portion of the band you are measuring.

For measurements of 1 to 4 gc on coaxial circuits, hp 536A Coaxial Frequency Meter is offered. Specifications for this high resolution, broadband, direct reading instrument are listed in the table.

Data subject to change without notice.

Specifications

Model No.	Frequency Range (gc)	Dial Calib. Accuracy (%)	Overall Accuracy**	Calibration Increment (mc)	Fits Waveguide (in.)	L. Size (in.)	H. Size (in.)	Wt. (lbs.)	Shipping	Price
536A	960 mc - 4.2 gc	0.1, 1 - 4.2 gc ± 0.17%, 1 to 4.2 gc ± 0.15, 0.76 - 1 gc ± 0.22%, 0.76 to 1 gc	± 0.17%	2 x 1	(coax)	9 5/8	5	13	20	\$500
532A	3.95 - 5.85	± 0.033	± 0.065%	1	2 x 1	6 1/4	9 1/4	8	9	\$375
J532A	5.30 - 8.20*	± 0.033	± 0.065%	2	1 1/2 x 3/4	6 1/4	9 1/4	8	8	\$350
H532A	7.05 - 10.0	± 0.040	± 0.075%	2	1 1/4 x 5/8	6 1/4	8	4 3/4	8	\$300
X532B	8.20 - 12.4	± 0.050	± 0.08%	5	1 x 1/2	4 1/2	6 1/4	2 3/4	5 1/2	\$200
M532A	10.0 - 15.0	± 0.053	± 0.085%	5	.850 x .475	4 1/2	6 1/4	2 3/4	3 1/2	\$200
P532A	12.4 - 18.0	± 0.058	± 0.10%	5	.702 x .391	4 1/2	6 1/4	2 3/4	3	\$275
K532A**	18.0 - 26.5	± 0.077	± 0.11%	10	1/2 x 1/4	4 1/2	5 1/2	2 3/4	4	\$350
R532A**	26.5 - 40.0	± 0.083	± 0.12%	10	3/40 x .220	4 1/2	5 1/2	2 3/4	4	\$400

Because of the wide frequency range of the J532A, frequencies from 7.6 to 8.2 gc can excite the TEM mode when the dial is set between 5.3 and 5.8 gc. *Circular Range adapters: K-band (UG-425/U) hp 11515A, \$35 each. R-band (UG-381/U) hp 11516A, \$40 each. ***Includes allowance for 0 to 100% relative humidity, temperature variation from 13°C to 33°C and backlash.

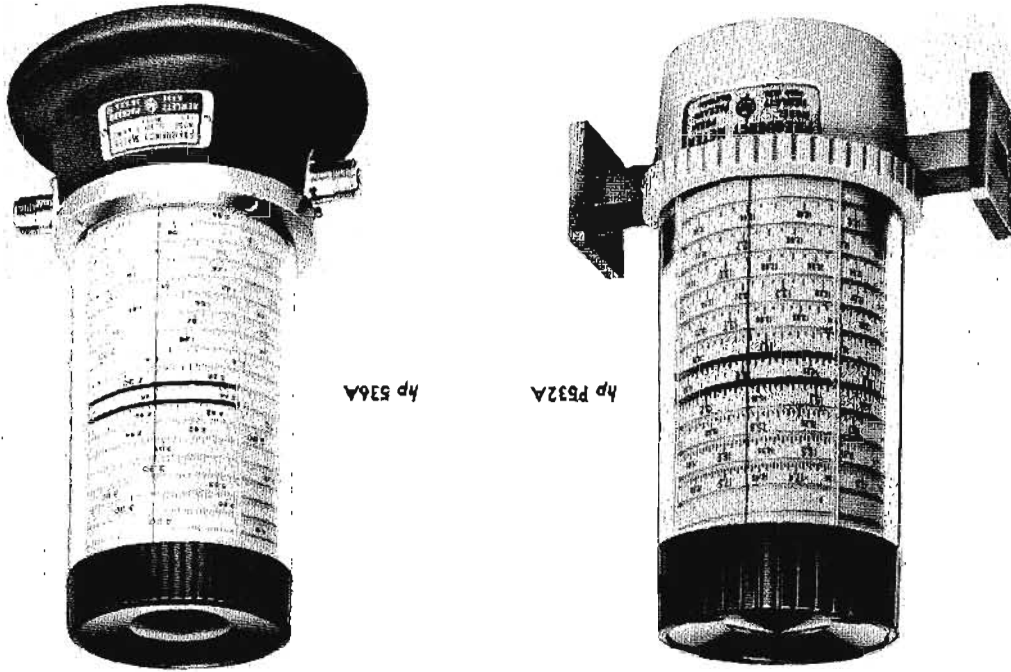

instruments which are capable of working with other instruments to provide a flexible signal generator system. The systems approach enables modification of the basic generator's capabilities to meet the more stringent requirements of present day rf systems design. These requirements include frequency stability-

A number of special-purpose signal generators using techniques similar to those of *hp* instruments are manufactured by Dymec, a division of Hewlett-Packard. See page 230 for specifications. The *hp* Model 8614A signal generator represents a new generation of

A signal generator is an oscillator calibrated to provide output signals of precisely known frequency and power. Signal generators are essential to many different types of measurements, and in order to serve their purpose adequately, they must meet certain minimum requirements, viz: (1) accurate frequency calibration, (2) accurate and variable output, (3) constant output impedance, (4) varied modulation capabilities, (5) low rf leakage, (6) low harmonic content, and (7) freedom from spurious or incidental modulation.

Hewlett-Packard offers a complete line of easy-to-use hf, vhf, uhf and shf signal generators, 14 precision instruments operating at frequencies between 50 kc and 40,000 mc. Each generator incorporates every basic requirement listed above and is designed so that both frequency and power output are direct reading. This assures utmost convenience and accuracy for all kinds of measurements, including receiver sensitivity, selectivity or rejection, signal to noise ratio, gain-bandwidth characteristics, conversion gain, antenna gain, transmission line characteristics, as well as for driving bridges, slotted lines, filter networks, etc.

Oscillator Types

Hewlett-Packard signal generators can be divided into three different groups according to their oscillator circuit design. Signal generators in Group I have master oscillator-power amplifier circuits; those in Group II have reflex klystrons in external cavities, and the doubler sets in Group III use broadband crystal harmonic generators to provide rf power at twice the driving frequency. Table I shows the important characteristics of these units. Group I signal generators (except *hp* 612A) are capacitively tuned. Group II signal generators (and *hp* 612A) are tuned by adjusting a shorting element which tunes the cavity resonator associated with the oscillator tube. Group III instruments depend on the driving generator for tuning and frequency accuracy.

Table I. Characteristics of *hp* Signal Generators.

Group	Generator	Frequency Range (mc)	Frequency Accuracy	Output Range	Output Accuracy	Max. SWR of Output	Modulation
I	606A	0.05 to 65	± 1%	0.1 μ v to 3 v	± 1 db	1.2	Sine wave, 400 cps \pm 5% pulse sq. wave
I	608C	50 to 480	± 1%	+ 13 to - 127 dbm	± 1 db	1.2	Sine wave, 400 and 1000 cps sq. wave
I	608D	10 to 420	± 0.5%	+ 7 to - 127 dbm	± 1 db	1.2	Sine wave, 400 and 1000 cps sq. wave
I	612A	450 to 1230	± 1%	+ 7 to - 127 dbm	± 1 db	1.2	Sine wave, 400 and 1000 cps pulse sq. wave
II	614A	800 to 2100	± 1%	- 3 to - 127 dbm	± 1 db	1.6	Pulse, FM sq. wave
II	8614A	800 to 2400	± 1/2%	+ 10 to - 127 dbm	± 0.5 db \pm 5 to - 127 dbm	2.0	Pulse, sq. wave, sine wave, FM
II	616B	1800 to 4200	± 1%	0 to - 127 dbm	± 1.5 db \pm 7 to - 127 dbm	1.8	Pulse, sq. wave, FM
II	8616A	1800 to 4500	± 1/2%	+ 10 to - 127 dbm	± 0.5 db \pm 5 to - 127 dbm	2	Pulse, sq. wave, sine wave, FM
II	618B	3600 to 7600	± 1%	0 to - 127 dbm	± 2 db \pm 7 to - 127 dbm	2	Pulse, FM sq. wave, FM
II	620A	7000 to 11,000	± 1%	0 to - 127 dbm	± 2 db \pm 7 to - 127 dbm	2	Pulse, FM sq. wave, FM
II	626A	10,000 to 15,500	± 1%	+ 10 to - 90 dbm	± 1 db \pm 2% of attenuation in db \pm 2.5 at + 10 dbm	2.5 at + 10 dbm	Pulse, sq. wave, FM
II	628A	15,000 to 21,000	± 1%	+ 10 to - 90 dbm	± 1 db \pm 2% of attenuation in db \pm 2.5 at + 10 dbm	2.5 at + 10 dbm	Pulse, sq. wave, FM
III	938A	18,000 to 26,500	That of driving source	0 to - 100 db	± 2 db \pm 2% of attenuation in db \pm 2.5 at + 10 db	2.5 at + 10 db	Depends on driving source
III	940A	26,500 to 40,000	That of driving source	0 to - 100 db	± 2 db \pm 2% of attenuation in db \pm 2.5 at + 10 db	2.5 at + 10 db	Depends on driving source

Figure 1. This *hp* signal generator system provides a 1 watt output with amplitude or pulse modulation. Frequency stability is $1 \times 10^{-7}/\text{sec}$, $1 \times 10^{-6}/\text{week}$; P.R.F.'s to 1 mc, 20 nsec rise and fall time.

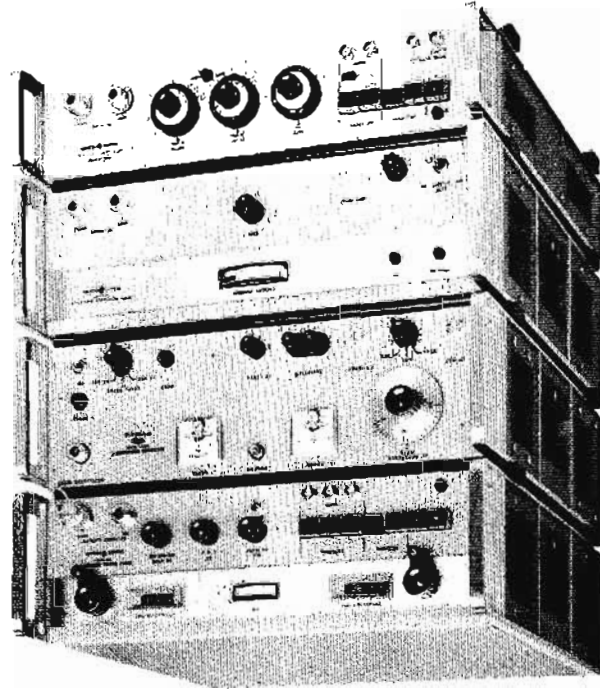

ties comparable to quartz crystal oscillators, provision for modulation by narrow pulses at higher repetition rates, modulation by sinusoids or special waveforms, and the generation of higher output power. Including all of these features in one package would result in a signal generator that would be much too expensive for general use, but the systems approach allows any one or a combination of features to be included as desired.

The modular cabinet program at Hewlett-Packard has opened the way for this multi-component system. A photo of a typical complete signal generating group using modular building blocks is shown in Figure 1. This system consists of the *hp* Model 8614A Signal Generator, the Dymec DX-2650A Frequency Synthesizer, the *hp* 8714A Modulator, and the *hp* 489A

Microwave Amplifier. The basic signal generator may be used with any combination of the other instruments to meet the user's special requirements. Other instruments may be added at a later date if new situations require them. The individual instruments and their contributions to the complete generator system are discussed in the following.

Basic Signal Generators

The *hp* Models 8614A and 8616A

Signal Generators by themselves represent an excellent source of microwave power for bench measurements. These generators provide at least 10 milliwatts of output power at any single frequency, or a leveled output of 1 milliwatt across the entire tuning range.

The 8614A and 8616A feature an electrically-controlled rf absorption modulator which uses PIN diodes as variable microwave loss elements. These diodes do not rectify any signal of a frequency higher than 100 mc because the reverse-bias swings of the signal are of such short duration that there is not sufficient time to sweep out the charge-carriers stored in the intrinsic silicon layer (between the P and N regions). Thus, PIN diodes conduct current in both directions at high frequencies, but their resistance to current flow is inversely proportional to the number of charge-carriers. The number of charge-carriers is in turn proportional to the forward bias so that the microwave loss can be controlled by changing the bias.

With such a modulator in a signal generator, the klystron operates at a constant power level while the PIN attenuator absorbs rf energy to modulate the output power. There is no klystron frequency pulling with this type of modulator so that the modulated output is virtually free of FM effects. Measurement accuracy is preserved and the way is opened to modulation by waveforms other than the square waves or pulses traditionally used for klystron modulation.

The PIN modulator enables the 8614A and 8616A outputs to be amplified waveforms in a linear fashion throughout a 20 db range. The generators also provide their own square-wave modulating waveform.

Oscillator Synchronizer

The Dymec DX-2650A Oscillator Synchronizer converts the basic microwave generator to a highly stable signal source when even better frequency stability than that provided by the free-running klystron oscillator is required. The synchronizer also works with the basic generator to form a precision FM source.

The DX-2650A synchronizer accepts a sample of the rf output of the signal generator and compares this to a harmonic of an internal crystal oscillator.

A feature of the "C" series of *hp* Sweep Oscillators Level Output From program.

Sweep Oscillators Level Output From

Sweep frequency generators are used extensively in the *hp* microwave development laboratories for broadband information of the new components under development. They eliminate many of the tedious point-by-point measurements previously required in waveguide component development program.

not go out of specification. Sweep frequency generators are used extensively in the *hp* microwave development laboratories for broadband information of the new components under development. They eliminate many of the tedious point-by-point measurements previously required in waveguide component development program.

Swept frequency techniques are used full for a wide variety of waveguide instrument and component testing. The *hp* pioneered reflectometer system employs swept frequency sources for fast, wide band presentation of swr measurements. These swept frequency test techniques are used extensively in the Hewlett-Packard waveguide testing department for tests on microwave components, the tests being both fast and comprehensive. X-Y recorder plots of swr and of attenuation versus frequency are typical of the measurements made. Reflectometer techniques assure that no hidden spurious responses slip through unnoticed on a microwave component. Broadband insertion loss tests on flap attenuators, for instance, assure that the attenuation versus frequency curve does not go out of specification.

In addition to precision signal generators, Hewlett-Packard offers six sweep oscillators covering frequencies in the range from 1.0 to 18.0 gc. These oscillators have voltage-tuned backward wave tubes which generate cw and

Sweep Oscillators

It should be pointed out that the individual instruments described in the preceding can be made to work with other pieces of equipment, since they have been designed in the *hp* tradition of the utmost in versatility. Because of the system approach, only the modules necessary for a given task need be procured initially, and others can be added at a future date.

New modulation techniques are possible with the *hp* modulators since they are connected in series for compound modulation, such as amplitude modulation of rf pulses. In fact, the modular signal generator system provides many other advantages, not possible with unit signal generators, such as simultaneous frequency and amplitude or pulse modulation of rf signals.

Other forms of amplitude modulation are possible with these instruments, directly to the modulator, resulting in rf output pulses equal in width and time to the external pulses.

The modulators have internal pulse and square wave generators which may operate at free-running rates between 50 cps and 50 kc or which may be triggered by external signals. The pulse generator will trigger at rates up to 1 mc. Pulse width is adjustable from 0.1 to 100 μ sec and the delay between the rf output pulse and the input trigger likewise is adjustable from 0.1 to 100 μ sec. External pulses may be applied directly to the modulator, resulting in

Minimum attenuation (or insertion loss) is 1.2 ± 0.5 db. What is more, the internal circuitry develops an extremely fast rf pulse rise time of 20 nanoseconds.

The *hp* 8714A and 8716A Modulators also use PIN attenuators as the modulating element. CW microwave power at any level up to 1 watt fed into the input can be reduced as much as 80 db at the output with the larger attenuators used in these instruments.

Modulators

Particular applications often require more microwave power than that normally supplied by most precision signal generators. Amplification of the signal generator output supplies this need; the new series of *hp* microwave amplifiers develop one watt of output power under the control of 1 milliwatt at the input. Minimum gain of these amplifiers is 30 db. Stability comparable to the well-known stability of *hp* signal generators is achieved through the use of highly regulated power supplies for all elements of the TWT, including the filament.

Microwave Amplifiers

The *hp* microwave amplifiers can be amplitude modulated to more than a 20 db off-on ratio throughout a modulating frequency range of dc to 100 kc. The *hp* microwave amplifiers are developed with unit filament.

Any change in phase relationship between the two signals results in an error signal which is fed back to the klystron to restore the normal phase difference. The klystron is thus phase-locked to the crystal so that it has the same frequency stability as the crystal. The internal crystal of the oscillator synchronizer has long term stability of 1 part in 10^8 per week and a short term stability of 1 part in 10^6 per second. The synchronizer also has a VFO which may be switched in to offset the klystron frequency under manual control by as much as ± 1 mc. Alternatively, the VFO can be frequency modulated by an external signal, resulting in frequency modulation of the klystron. FM deviations of up to 500 kc dc to 50 kc are possible with this arrangement. The deviation is metered easily on either a voltmeter or an oscilloscope. More complete data on the Dymec DY-2650A will be found on page 219, where some of its other uses are also explained.

For better leveling than that of the simple system in the "C" series sweepers *hp* has developed a refined leveling system which is unmatched today. This system often is referred to as "super-leveling."

The super-leveling system is based on the accurate power measurement capabilities of the *hp* 431B Power Meter. The dc recorder output of the 431B, which is proportional to the rf power, is fed to the *hp* HO1-8401A Leveler Amplifier which compares this dc to a reference. From this comparison, an error signal is derived and applied to the amplitude controlling element of the microwave tube, holding the power output constant.

The 431B Power Meter is significantly better for sensing microwave power than the crystal detectors normally used for this purpose. Crystal detectors normally have an swr of 2 which causes reflection losses and makes

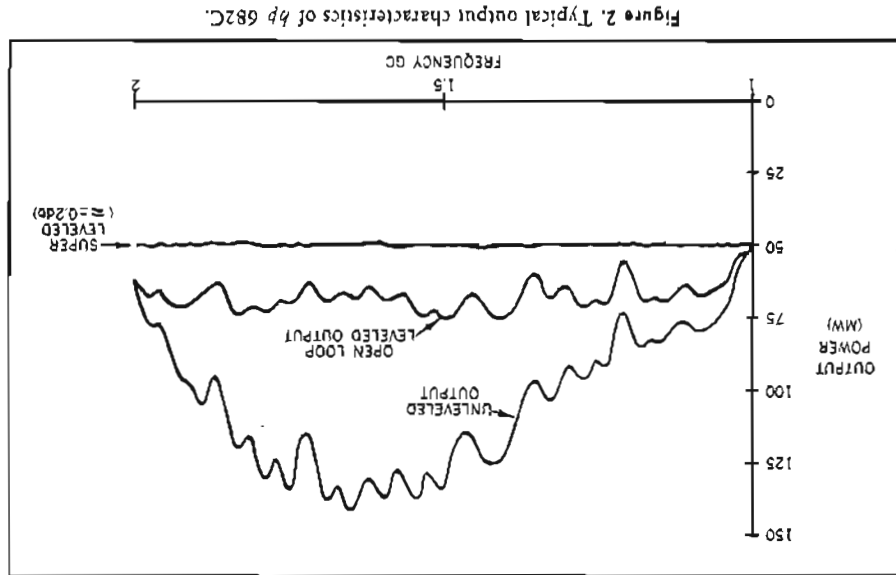

Figure 2. Typical output characteristics of *hp* 682C.

hp 682C. helix voltage so that rf output variations typical of the backward wave oscillator are removed. Only the minor measurements or control. Since the detector is connected to imperfect sources, such as the side arm of a directional coupler, reflection losses are variable depending on the length of the line involved. This results in fine gain variations in the swept power output.

The broadband, low swr of the thermistor mounts used with the 431B Power Meter reduces reflection losses to a negligible value. Therefore, the degree of leveling achieved with this system becomes a function of the broad-band response curve of the directional couplers and of the directivity of the coaxial cable normally is employed, directional couplers are available having a coupling variation of less than ± 0.2 db over an octave band of frequencies. These couplers have low directivity, however, and leveling action can approach ± 0.2 db only when working into a relatively well-matched load.

In waveguide systems, even the best couplers have coupling variations of ± 0.5 db. However, the *hp* 752 series of couplers have been designed such that they all have the same coupling variation to cancel out coupling variations when two are used "back-to-back" in reflectometers. In leveling applications, the back-to-back technique is employed to reduce coupler variations.

Figure 3 shows a typical system where

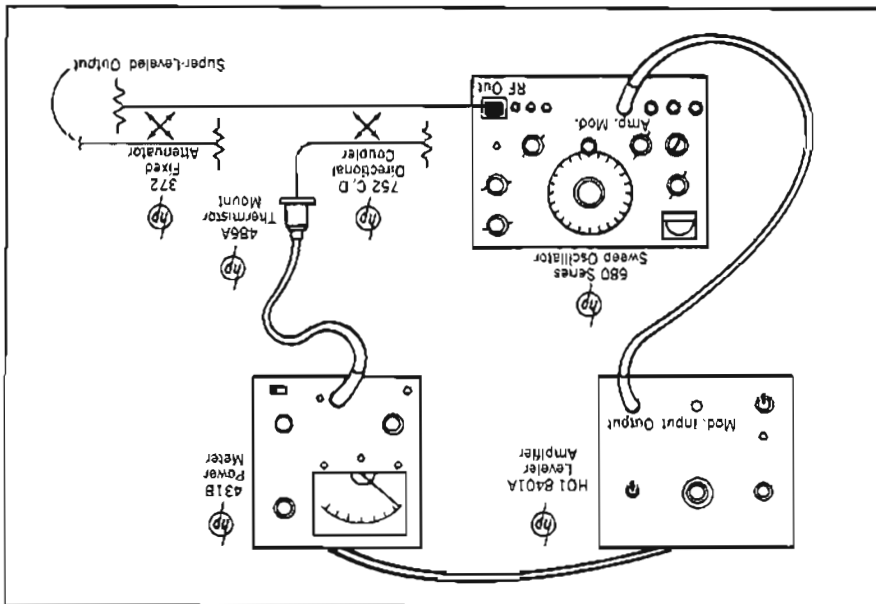

Figure 3. A setup to "super-level" the output of an *hp* 680 Series Sweep Oscillator.

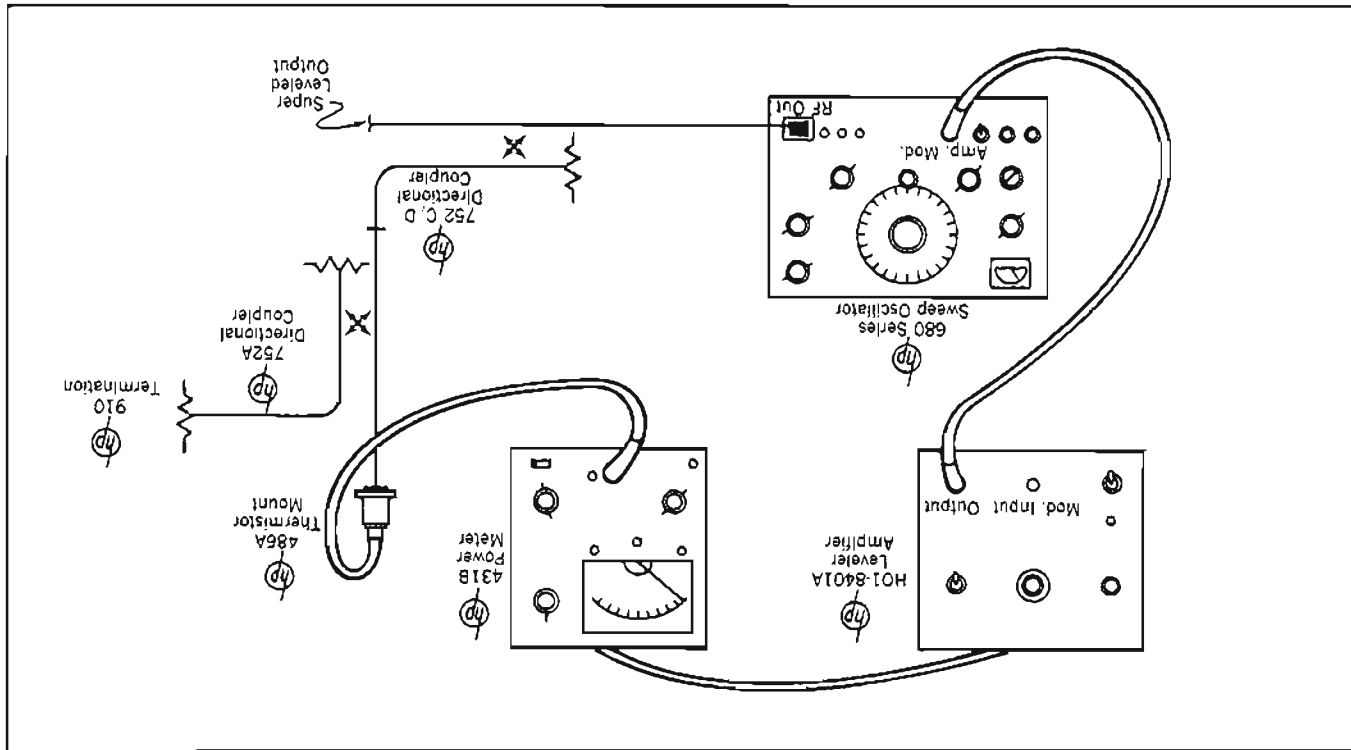

Figure 4. A "super-leveling" system for swept frequency output greater than 1 milliwatt.

1 milliwatt of leveled output power is desired. Here, the power output of the sweeper is sampled by a 752C High Directivity Coupler. The output of the secondary arm is maintained constant by this system so that the power in the primary line varies according to the coupling of the coupler, i.e., ± 0.5 db. The *hp* 372 Attenuator smooths out this variation. The 372 is identical to the 752 except that it has only two terminals, the other two being terminated. Thus, its insertion loss varies through the swept range in exactly the same manner as the coupling to the secondary arm of the 752 coupler. The two act in

opposite manner, and the output will be as smooth as the two couplers track. Since the swr of the 372 is less than 1.05, this technique results in good generator swr, so important in most microwave measurements. If powers less than 1 mw are desired from this system, then a good, broadband microwave attenuator, such as one of the *hp* 382 752C or D Coupler, and leveled output is available at nearly the same level as the minimum power output of the device being leveled.

If powers greater than one milliwatt are required, an alternate system is recommended. This system is shown in Figure 4.

Here, a 752A 3 db coupler is used in a unique manner. The insertion loss of the primary arm of this coupler is also centered around 3 db, so that its insertion loss follows a curve which is directly opposite to the normal secondary arm coupling curve. Thus, the 752A cancels out the coupling curve of the 752C or D Coupler, and leveled output is available at nearly the same level as the minimum power output of the device being leveled.

The *hp* series 489A, 491C, 493A, 495A One-Watt Microwave Amplifiers can also be leveled in the same manner.

606A HF SIGNAL GENERATOR  Convenience and Utility in a 50 KC to 65 MC Signal Generator

Advantages:

- Wide range. Includes 30 and 60 MC IF bands
- Constant output level
- Constant modulation level
- Wide modulation capabilities
- 3 volt output into 50 ohms
- Crystal calibrator insures exact frequencies
- Low envelope distortion

Uses:

- Measuring receiver and IF circuit gain, selectivity and image rejection
- Driving bridges, antennas, filters
- Measuring harmonic distortion of AM receivers

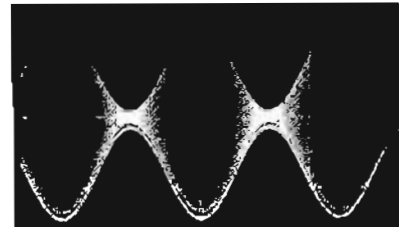

Figure 1. Dual-trace presentation comparing modulated output from 606A with internal 1 KC modulating waveform (positioned closely above rf envelope).

Here in the 606A is the most convenient and versatile signal generator ever manufactured. Its wide frequency and output range and excellent modulation characteristics fit the 606A for many measurements.

Constant Output—Modulation

A feedback circuit maintains both output level and percent modulation essentially constant over the entire frequency range. Thus, it is usually unnecessary to readjust either the output level or modulation controls when conducting measurements at various frequencies. Even the output level can be varied without seriously affecting percent modulation. Another advantage provided by the feedback circuit is the reduction of envelope distortion during modulation.

Low Distortion

Because envelope distortion is low, overall distortion measurements may be made on high-fidelity AM receivers by applying the 606A output to the receiver's antenna terminals (see Figure 1).

Broad Modulation Bandwidth

606A may be modulated with signals from dc to 20 KC, by square waves and other complex signals. Square wave

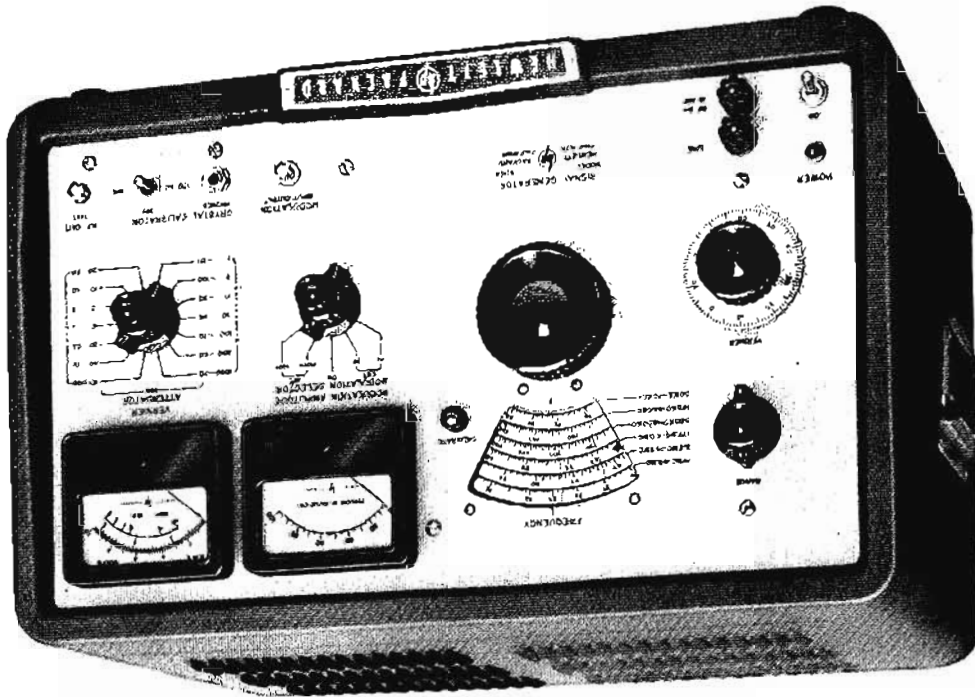

Output Impedance: 50 ohms, SWR less than 1.1 on 0.3 volt and lower ranges; less than 1.2 on 1 volt and 3 volt ranges.

BNC output connector (female).

Spurious Harmonic Output: Less than 3%.

Leakage: Negligible; permits receiver sensitivity measurements down to at least 0.1 microvolt.

Amplitude Modulation: Continuously adjustable from 0 to 100%. Indicated by a panel meter. Modulation level is constant within ± 0.5 db regardless of carrier frequency and output level changes.

Internal Modulation: 0 to 100% sinusoidal modulation at 400 cps $\pm 5\%$ or 1,000 cps $\pm 5\%$. Internal modulation voltage appears at modulation jack.

Modulation Bandwidth: DC to 20 KC maximum, depends on carrier frequency, f_c , and percent modulation as shown in the following table:

Max. Mod.	30% Mod.	70% Mod.	Squarewave Mod.
$\frac{0.06 f_c}{0.003 f_c}$	$\frac{0.02 f_c}{0.003 f_c}$	$\frac{0.06 f_c}{0.003 f_c}$	$\frac{0.06 f_c}{0.003 f_c}$

External Modulation: 0 to 100% sinusoidal modulation dc to 20 KC. 4.5 volts peak produces 100% modulation at modulating frequencies from dc to 20 KC. Input impedance is 600 ohms. May also be modulated by square waves and other complex signals.

Envelope Distortion: At output levels of 1 v or less: less than 1% at 30% modulation, less than 3% from 0 to 70% modulation using internal 400/1,000 cps source.

Modulation Meter Accuracy: Within $\pm 5\%$ of full scale (0 to 90% modulation) for modulating frequencies to 10 KC, within $\pm 10\%$ of full scale from 10 to 20 KC.

Incidental FM: At 1 v or less output and 30% amplitude modulation: 0.0025% or 100 cps, whichever is greater.

Spurious FM: Less than 0.0001% or ± 20 cps, whichever is greater.

Spurious AM: Hum and noise sidebands are 70 db below carrier down to thermal level of 50-ohm output system.

Frequency Drift: (on 1 v and lower ranges). Less than 0.005% or 5 cps, whichever is greater, for a 10-minute period after warmup or restabilization at frequency of use.

Power: 115 or 230 v $\pm 10\%$, 50 to 1,000 cps, 135 watts.

Dimensions: Cabinet Mount: 20 $\frac{3}{4}$ " wide, 12 $\frac{1}{2}$ " high, 14 $\frac{3}{4}$ " deep. Rack Mount: 19" wide, 10 $\frac{1}{2}$ " high, 13 $\frac{3}{8}$ " deep behind panel.

Weight: Net 46 lbs. Shipping 61 lbs. (cabinet mount).

Net 43 lbs. Shipping 64 lbs. (rack mount).

Accessories Available: 11507A Output Termination with 50 ohms termination, 5 ohms termination (10:1 voltage division), and IRE standard dummy antenna (10:1 voltage division), \$70.00.

Price: 606A, \$1,350.00 (cabinet); 606AR, \$1,335.00 (rack mount).

Data subject to change without notice.

Figure 2. Dual-trace presentation showing carrier in the broadcast band-modulated by a 1 KC square wave.

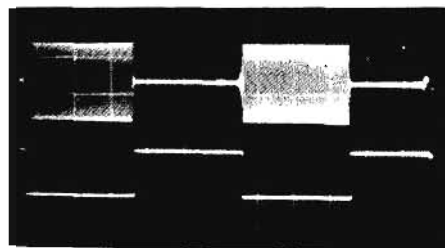

and pulse modulation of the carrier permit examination of the overall transient and pulse response of receivers. Such modulation characteristics permit tone-burst modulation and remote programming as well as the more conventional applications.

11507A Output Termination (10:1) and IRE dummy antenna. See "Accessories Available" under "Specifications." This multipurpose termination further enhances the usefulness of the 606A by:

- providing a matched 50-ohm termination and reducing the source impedance to 25 ohms.
- providing a 20 db (10:1) divider which also reduces source impedance to 5 ohms.
- providing a dummy antenna having the IRE standard characteristics for receiver measurements.



Specifications 606A

Frequency Range: 50 KC to 65 MC in six bands:

50 - 170 KC	1.76 - 6.0 MC
165 - 560 KC	5.8 - 19.2 MC
530 - 1800 KC	19.0 - 65.0 MC

Frequency Accuracy: Within $\pm 1\%$.

Frequency Calibrator: Crystal oscillator provides check points at 100 KC (useful to 6 MC), and 1 MC intervals (useful to 65 MC) accurate within 0.01% from 0° to 50° C.

RF Output Level: Continuously adjustable from 0.1 μ v to 3 volts into a 50-ohm resistive load. Calibration is in volts and dbm (0 dbm is 1 milliwatt or 0.223 volts rms into 50 ohms).

Output Accuracy: Within ± 1 db into 50-ohm resistive load.

Frequency Response: Within ± 1 db into 50-ohm resistive load over entire frequency range at any output level setting.

Testing and aligning vhf communications receivers
 Measuring gain, sensitivity, selectivity, image
 rejection of receivers, IF amplifiers, broadband am-
 plifiers, and other vhf equipment
 Driving bridges, slotted lines, antennas, filter
 networks, etc.

Uses:

Wide range, direct calibration
 Convenient operation
 Incidental FM less than 1 KC
 Drift less than 0.005%
 High power output
 Microsecond pulsing
 Broad modulation capabilities

Advantages:

Output of the 608D is calibrated from 0.1 μ v to 0.5 v throughout the frequency range of 10 to 420 MC. A built-in crystal calibrator provides accurate frequency check points in 1 and 5 MC steps throughout range. Modulation capabilities are extremely broad allowing pulse and transient testing of vhf receivers. At the same time, envelope distortion, incidental FM and drift are kept low so that measurements of high-slope narrow band circuits are accurate and reliable. Low incidental FM is the result of using a buffer amplifier between the master-oscillator and power amplifier. Pulses as short as 1 μ sec are available at rf output frequencies above 100 MC. Percentage modulation is read directly on the front panel meter.

Premium Quality 608D

Hewlett-Packard 608C,D are designed as broadly applicable vhf signal generators. They offer the highest stability attained in production equipment of their type. There is almost a complete absence of incidental FM (less than 1 KC for the 608D) and frequency drift is held low despite line voltage variations. This performance is possible because of the master oscillator output amplifier construction and close filament regulation of the tubes.

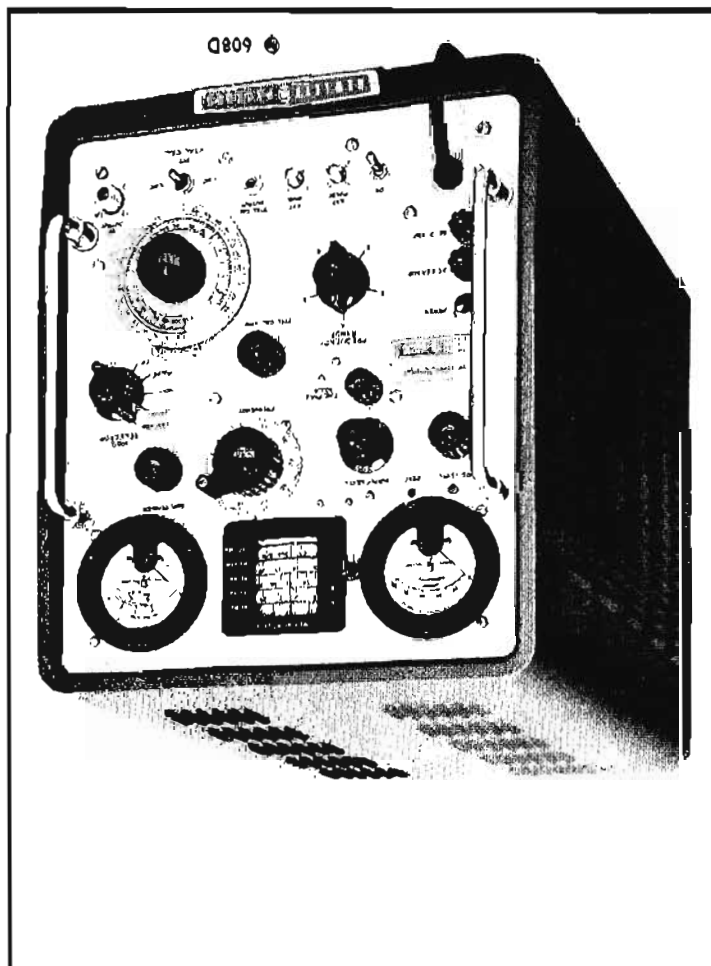

hp 608C,D VHF
SIGNAL GENERATORS

Finest Tools Available
 for Measurements 10 to 480 MC

Finest Construction

An important feature of 608D is the mechanical design and construction employed throughout. Aluminum castings and cabinets reduce weight at no sacrifice in strength or ruggedness. Circuitry is clean and accessible. Dial, capacitor and turret drives are all precision built and ball-bearing equipped. Variable capacitors are specially manufactured by 4 and feature electrically welded Invar low temperature steel plates to minimize drift. Sealed transformers are used throughout, and construction is millitized.

608C VHF Signal Generator

The 608C is a high power, stable, and highly accurate VHF signal generator for general laboratory and field use. Utilizing a master oscillator-power amplifier circuit, Model 608C provides 1 volt maximum output and a broad frequency coverage of 10 to 480 MC. It may be amplitude modulated to 95% and provides high quality pulses as short as 1 μ sec at rf output frequencies above 100 MC. As in 608D, rf leakage is negligible, and the rf attenuator is calibrated to 0.1 μ V.

608C is especially suited for measurements of gain, selectivity, sensitivity or image rejection of receivers, IF amplifiers, broadband amplifiers and other vhf equipment. It also provides ample output for driving bridges, slotted lines, transmission lines, antennas, filter networks, and other circuits operating in the vhf band.

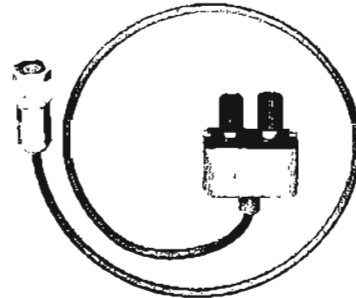

Accessories

608A

Terminated Output Cable, 608A, is designed for use with 608D and 608C vhf signal generators. It provides an accurate termination which may be directly connected to the point of a circuit at which the signal voltage is to be injected.

Another accessory, the 608A Fuseholder is particularly useful for these signal generators when tests on transmitters are being made. The Fuseholder protects the output attenuator of the signal generator should the transmitter be keyed while the 608 is connected to the antenna.

Specifications

608D

Frequency Range: 10 to 420 MC, 5 bands.
Tuning Control: Main dial calibrated in MC. Vernier interpolation dial, 45" scale length. Calibrated every other MC, 130 to 270 MC; every 5 MC, above 270 MC.
Resettable: Better than $\pm 0.1\%$ after warmup.
Crystal Calibrator: Provides frequency check points every 1 MC (useful to 270 MC) or 5 MC over the range of the instrument. Headphone jack provided for audio frequency output (headphones not included). Crystal frequency accuracy better than 0.01% at normal ambient temperatures.

608C

Cursor on frequency dial adjustable over small range to aid in interpolation adjustment. Calibrator may be turned off when not in use.
Frequency Drift: Less than 0.005% over a 10 minute interval after initial instrument warmup (15° C to 35° C ambient). When frequency is changed by dial, instrument must stabilize one minute for each 10% frequency change. When frequency is changed by bandswitching, 10 minutes are required to stabilize.
Output Level: 0.1 μ V to 0.5 v into 50-ohm resistive load. Attenuator dial calibrated in volts and dbm. (0 dbm equals 1 mV).
Voltage Accuracy: ± 1 db full range into 50-ohm load.
Generator Impedance: 50 ohms, maximum SWR 1.2.
Envelope Distortion: Less than 5% at 30% sine wave modulation; less than 10% at 50% sine wave modulation.
Internal Modulation: 400 cps $\pm 10\%$ and 1,000 cps $\pm 10\%$ of 0 dbm and below at modulation frequencies 20 cps to 20 KC. Input requirements: 0.5 v rms across 15,000 ohms.
External Pulse Modulation: Positive 5 volt peak pulse required. 40 MC to 220 MC; combined rise and decay time of rf pulse less than 4 μ sec.
220 MC to 420 MC; combined rise and decay time of rf pulse less than 1 μ sec.
Residual level at least 20 db below 0.5 volt peak pulse output.
Modulation Meter Accuracy: $\pm 10\%$ of full scale, 30% to 95% modulation.
Incidental FM: Less than 1,000 cycles at 50% AM for rf output frequencies above 100 MC; less than 0.001% at 30% amplitude modulation for rf output below 100 MC.
Leakage: Negligible; permits sensitivity measurements to at least 0.1 μ V.
Filament Regulation: Provides high oscillator and amplifier stability for line voltage change.
Power: 115 or 230 v $\pm 10\%$, 50 to 1,000 cps, 220 watts.
Dimensions: Cabinet Mount: 13 1/4" wide, 14" high, 16 3/8" high, 21" deep. Rack Mount: 19" wide, 14" high, 18 3/8" deep behind panel.
Weight: Net 62 lbs. Shipping 73 lbs. (cabinet). Net 62 lbs. Shipping 89 lbs. (rack).
Accessories Available: 11508A Output Cable, \$18.00; 10303A Video Cable Assembly, \$6.50; 11500A RF Cable Assembly, \$15.00; 360A Low Pass Filter, \$70.00; 11509A Fuseholder, \$25.00.
Price: 608D, \$1,300.00 (cabinet); 608DR, \$1,320.00 (rack mount).

Same as 608D, except:

Frequency Range: 10 to 480 MC, 5 bands.

Frequency Calibration Accuracy: $\pm 1\%$ full range.

Crystal Calibrator: In Model 608D only.

Output Level: 0.1 μ V to 1.0 v into 50 ohm resistive load.

Incidental FM: Less than 0.0025% at 30% amplitude modulation for rf output frequencies 21 to 480 MC.

Price: 608C, \$1,200.00 (cabinet); 608CR, \$1,220.00 (rack mount).

Data subject to change without notice.

hp 612A UHF SIGNAL GENERATOR

All-Purpose UHF Signal Generator, 450 to 1230 MC



MO-PA Circuit

The master oscillator-power amplifier circuit in hp 612A provides a high output power of 0.5 v into 50 ohms over the full frequency range of 450 to 1230 mc. There is very low incidental FM (less than 0.002% at 30% AM) and excellent modulation capabilities by all frequencies from 20 cps to 5 mc. The instrument may be modulated internally or externally, amplitude modulated, or pulse modulated (good rf pulses 0.2 μ sec or longer). Pulse modulation may be applied to the amplifier, or direct to the oscillator when high on-off signal ratios are required. (Signal may be completely cut off during pulses.) A dc restorer circuit allows modulation up or down from preset level to simulate tv modulation characteristics accurately. The large, easily read percentage modulation meter responds to peak value, indicating degree of pulse modulation.

Advanced Design

The oscillator-amplifier circuit in hp 612A employs high frequency pencil triodes in a cavity-tuned circuit for precise tracking over the entire band. The tuned cathode, tuned-plate oscillator drives a double-tuned power-amplifier of 15 mc bandwidth. (This circuitry produces the high modulation percentages to 5 mc and minimum incidental FM which characterize the instrument.) Non-contacting cavity plungers are die cast to precise tolerances, then injection molded with a plastic filler for optimum Q. The frequency drive is a direct screw-operated mechanism, free from backlash. A waveguide beyond cutoff piston attenuator and crystal monitor circuit are used to insure accurate, reliable output down to 0.1 μ v. The attenuator is calibrated over a range of 131 db. It has been carefully designed to provide a constant impedance versus frequency characteristic. The swr of the output system is less than 1.2 over the complete frequency range when used into a 50-ohm impedance.

Advantages:
0.5 v output over full range
UHF-TV modulation capability
Direct reading in both frequency and amplitude
CW, AM and pulse output
Low incidental FM
Generator matched to 50 ohms
Microsecond pulsing

Uses:
Measure gain, selectivity, sensitivity
and image rejection of receivers and amplifiers
Drive bridges, slotted lines, antennas
and filter networks
Test uhf-tv equipment under actual
modulation conditions

Here is an all-purpose, precision signal generator particularly designed for utmost convenience and applicability throughout the important uhf-tv frequency band. It is ideally suited for measurements in uhf-television broadcasting, studio-transmitter links, citizen's radio and public service communications systems. The hp 612A also covers the important frequencies used in aircraft navigation aids such as DME, TACAN and airborne transponders. Accessory modulators, available from many of the manufacturers of these navigational aids, enable the 612A to provide the complex modulation patterns required for testing and aligning these systems. In the laboratory, the 612A is a convenient power source for driving bridges, slotted lines, antennas and filter networks. In addition, the hp 8714A Modulator (see page 218) can be used with the 612A to obtain rf pulses with 20 nsec rise time and 0.1 μ sec minimum duration—with "on-off" ratios approaching 80 db.

Figure 1. Block diagram, @ 612A Signal Generator.

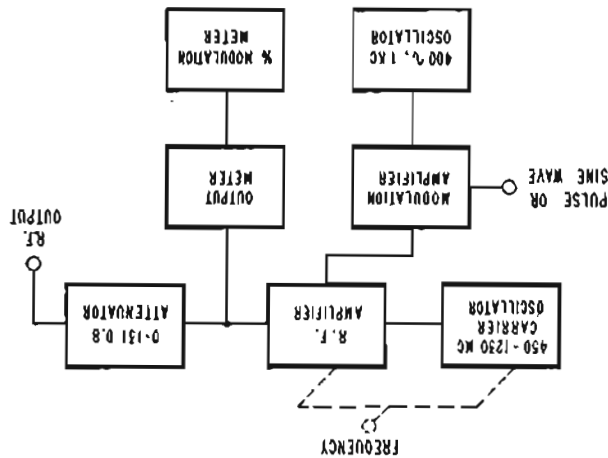

Data subject to change without notice.

Weight: Net 57 lbs. Shipping 68 lbs. (cabinet). Net 57 lbs. Shipping 83 lbs. (rack mount).
 Accessories Available: hp 11500A RF Cable Assembly, \$15; hp 10503A Video Cable Assembly, \$6.50; 360B Low Pass Filter (may be used where harmonic output must be reduced to a minimum, as in slotted line measurements), \$60.
 Price: hp 612A, \$1400 (cabinet); hp 612AR, \$1420 (rack mount).

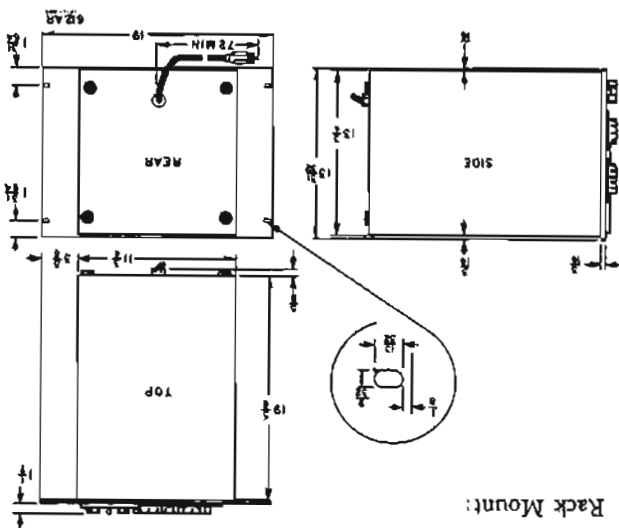

Specifications

Frequency Range: 450 to 1230 mc in one band; scale length approximately 15 inches.
 Calibration Accuracy: Within $\pm 1\%$; resetability better than 5 mc at high frequencies.
 Output Voltage: 0.1 μ v into 50 ohm load; calibrated in volts and dbm (0 dbm = 1 mw).
 Output Accuracy: ± 1 db, 0 to -127 dbm over entire frequency range.
 Internal Impedance: 50 ohms; maximum swr 1.2.
 Leakage: Negligible; permits receiver sensitivity measurements down to 1 μ v.
 Amplitude Modulation: 0 to 90% at audio frequencies, indicated by panel meter. Accuracy, $\pm 10\%$ of full scale, 30% to 90% modulation.
 Internal Modulation: 400 cps and 1000 cps $\pm 10\%$. Envelope distortion less than 2% at 30% modulation.
 External Modulation: 20 cps to 5 mc. Above 470 mc, 2 v rms produces 85% AM at modulating frequencies up to 1 mc; at least 40% AM at 5 mc. Modulation may be up or down from the carrier level or symmetrical about the carrier level. Positive or negative pulses may be applied to increase or decrease rf output from the carrier level.
 Pulse Modulation: Pulse 1 (pulse applied to amplifier): Positive or negative pulses, 4 to 40 v peak produce an rf on-off ratio of at least 20 db. Minimum rf output pulse length, 0.2 μ sec. Pulse 2 (pulse applied to oscillator): Positive or negative pulses, 4 to 40 v peak. No rf output during off time. Minimum rf output pulse length, 1 μ sec.
 Power: 115 or 230 v $\pm 10\%$, 50 to 1000 cps, 215 watts.
 Dimensions: Cabinet: 13 1/2" wide, 16 1/2" high, 21 1/2" deep.

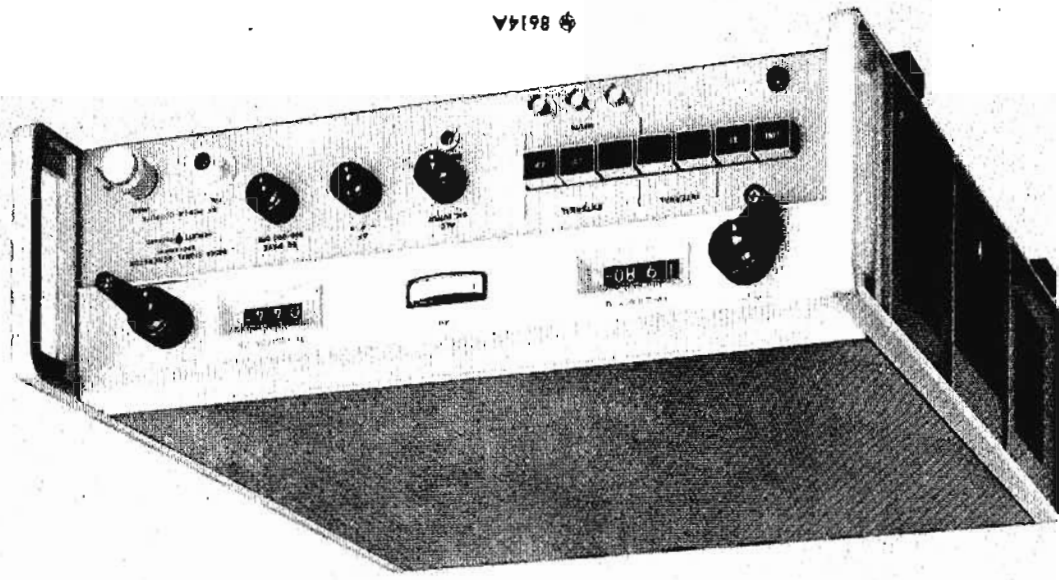

NEW IN THIS
CATALOG

Stable, Easy to Use, Cover 800 MC to 4.5 GC

8614A, 8616A SIGNAL GENERATORS



Reduce operator error and fatigue with these *hp* signal generators and receive stable, accurate signals from 800 to 2400 mc (*hp* 8614A) and from 1.8 to 4.5 gc (*hp* 8616A). Both frequency and attenuation are set on direct-reading digital dials, while function is easily selected by pushbuttons. Selectable functions include cw, leveled output, square wave modulation and external amplitude, pulse or frequency modulation. Amplitude, frequency and square wave modulation can be accomplished simultaneously with or without leveling.

- Advantages:**
- Digital frequency and attenuator dials
 - At least 10 mw output
 - Amplitude modulation capability
 - Automatic power leveling
 - Compact, only 5 1/4" high

- Use to Measure:**
- Receiver sensitivity
 - Signal-noise ratio
 - Conversion gain
 - Standing wave ratios
 - Transmission line characteristics
 - Antenna characteristics

Data subject to change without notice.

Price: hp 8614A, \$1650; hp 8616A, \$1650.
 Weight: Net 48 lbs. Shipping 60 lbs.
 high, 16 3/8" deep behind panel (rack mount).
 hardware furnished converts cabinet to 19" wide, 5 1/4" high, 16 3/8" deep (cabinet);
 Dimensions: 16 3/4" wide, 5 1/2" high, 18 3/8" deep (cabinet);
 Power: 115 or 230 volts $\pm 10\%$, 50 to 60 cps, approxi-
 mately 125 watts.
 klystron.
 panel connector is dc coupled to the repeller of the
 External FM: (a) Front panel connector capacity coupled
 to the repeller of the klystron. (b) Two-terminal rear
 External AM: DC to 1 mc.
 External Pulse: 50 cps to 500 kc.
 Other frequencies available.
 Internal Square Wave: 800 to 1200 cps, 1 μ sec rise time.
 Modulation: On-off ratio at least 20 db for square wave,
 pulse and amplitude modulation.
 Internal Impedance: 50 ohms, SWR less than 2.
 Control.

RF Output Power: + 10 dbm (0.7 v) to - 127 dbm
 (0.1 μ v) into a 50-ohm load. Output attenuator dial
 directly calibrated in dbm from 0 to - 127 dbm. A second
 uncalibrated rf output (approximately 1/2 mw minimum)
 is provided on the front panel.
 RF Output Power Accuracy: ± 0.75 db + attenuator ac-
 curacy (- 7 to - 127 dbm); ± 3 db (0 to - 7 dbm);
 uncalibrated above 0 dbm. (Includes leveled output vari-
 ations.)
 Attenuator Accuracy: ± 0.07 db/10 db from - 7 to
 - 127 db; direct reading linear dial, 0.2 db across entire
 leveled output; Constant within ± 0.5 db across entire
 frequency range at any attenuator setting below 0 db.
 Output power can be adjusted from - 4 to + 4 dbm of
 the normal calibrated level with the Automatic Level Con-
 trol.

Frequency Range: hp 8614A, 800 to 2400 mc; hp 8616A,
 1.8 to 4.5 gc. Single, linearly calibrated control, direct
 reading within 2 mc.
 Vernier: ΔF control has range of 2 mc for fine tuning.
 Frequency Calibration Accuracy: 8614A, ± 5 mc; 8616A,
 ± 10 mc.
 Frequency Stability: Approximately 0.005%/°C change in
 ambient temperature, less than 2500 cps peak incidental
 FM, less than 0.003% change for line voltage variation
 of $\pm 10\%$. When used with DY-2650A Oscillator
 Synchronizer (page 219), a short term stability of 1 part
 in 10^6 and a long term stability of 1 part in 10^8 are
 attained.

Specifications

A unique PIN diode modulator permits amplitude modu-
 lation from dc to 1 mc or furnishes rf pulses with a 1 μ sec
 rise time. This broad modulation bandwidth permits remote
 control of output level or precise leveling using external
 equipment. The internal leveling is also obtained by using
 a PIN modulator.
 When up to one watt output is required above 1 gc, the
 hp 489A (1 to 2 gc) or hp 491 (2 to 4 gc) Microwave
 Amplifiers (see pages 202 and 203) serve as ideal power
 boosters. The hp 8714A and 8716A Modulators (see page
 218) are also available for use with the 8614A and 8616A
 Signal Generators when a sophisticated high-speed, low-
 jitter modulation system is required.

Modulation Capabilities

Two rf power outputs are simultaneously available on
 separate front-panel connectors. One provides at least 10
 mw or a leveled output, from 0 dbm to - 127 dbm, flat
 within $\pm 1/2$ db across the band without resetting the at-
 tenuator or power monitor. The other provides an uncali-
 brated output of at least 1/2 mw.

Two Outputs

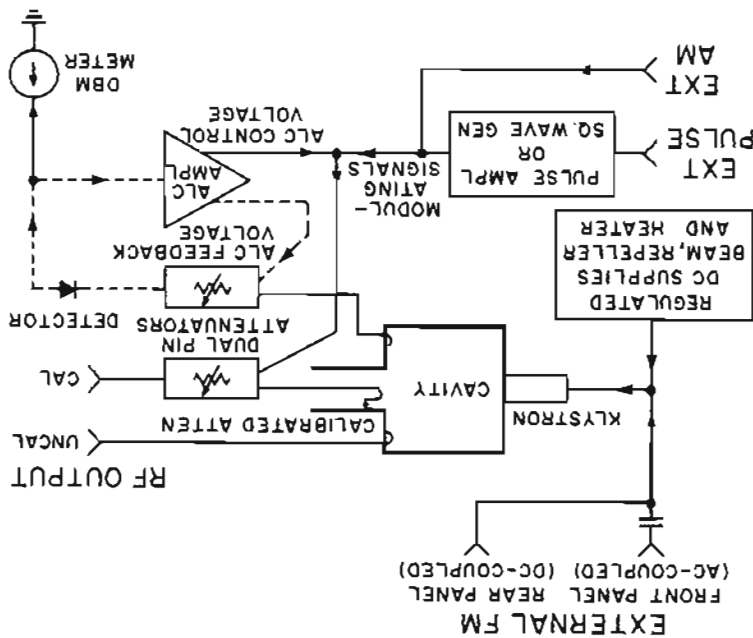

Figure 1. Simplified block diagram of hp Models 8614A and 8616A Signal Generators. The dashed line shows the leveling control circuit.

The hp Models 8714A and 8716A Modulators provide extremely fast, low-jitter rf pulses from any signal source operating between 800 mc and 4.5 gc. They will modulate any cw signal up to 1 watt, the 8714A from 800 to 2400 mc and the 8716A from 1.8 to 4.5 gc. A pulse modulated rf envelope can be obtained with 20 nsec rise and fall times, 0.1 μ sec minimum duration, and less than 1 nsec jitter. This outstanding performance is achieved by using an hp-developed PIN diode modulator as an absorption attenuator. The PIN modulator also permits square wave and amplitude modulation. Consisting of electrically controlled absorption diodes mounted in a strip transmission line, PIN modulators overcome both the bandwidth limitations imposed by high Q rf output circuits and the incidental frequency modulation created by other methods of amplitude modulating rf oscillators. Modulation is accomplished by varying the attenuation of the stripline, so that rise and fall times are essentially as fast as diode electrical control. Models 8714A and 8716A Modulators also facilitate generation of rf pulses which have a large on-off ratio, because of their low minimum insertion loss and high maximum attenuation. The PIN unit does not reflect the attenuated energy as does the crystal switch type of modulator, and therefore, the load presented to the driving source remains constant, independent of the instantaneous modulation conditions.

Specifications

RF Characteristics

Frequency Range: hp 8714A, 800 to 2400 mc; hp 8716A, 1.8 to 4.5 gc.
 Insertion Loss: 8714A, 2 db max; 8716A, 3 db max.
 Insertion Loss Variation: \pm 0.5 db.
 Off-on Ratio: 80 db minimum.
 RF Input Power: Maximum 1 watt.
 SWR: 1.5 maximum at minimum attenuation; 2.0 maximum at 80 db attenuation.

Internal Modulation

Square Wave: Frequency: Continuously variable from 50 cps to 50 kc, 3 decade ranges.
 Symmetry: Better than 40/60%.
 RF Output: Rise time < 20 nsec, decay time < 20 nsec.
 Pulse: Repetition Rate: Continuously variable from 50 cps to 50 kc, 3 decade ranges.
 Delay: Continuously variable from 0.1 μ sec to 100 μ sec, in 3 decade ranges (between sync out pulse and rf output pulse).
 Width: Continuously variable from 0.1 μ sec to 100 μ sec in 3 decade ranges.
 RF Output: Rise time < 20 nsec, decay time < 20 nsec.

External Sync

Amplitude: 5 v to 15 v peak.
 Waveform: Pulse or sine wave.
 Polarity: Either positive or negative.
 Input Impedance: Approx. 600 ohms, dc coupled.
 Rate: Subject to internal recovery time considerations; see graph.

General

Power: 115 or 230 volts \pm 10%, 50 to 1000 cps, approx. 10 watts.
 Dimensions: 16 $\frac{3}{4}$ " wide, 4" high, 18 $\frac{3}{8}$ " deep; hardware furnished for conversion to 19" by 3 $\frac{1}{2}$ " rack mount.
 Weight: Net 23 lbs. Shipping 35 lbs.
 Price: hp 8714A, \$850; hp 8716A, \$850.

External Modulation

Pulse Input: Amplitude and Polarity: 5 v to 15 v peak, either positive or negative.
 Repetition Rate: Maximum average prf, 1 mc. Maximum peak input impedance: Approx. 600 ohms, dc coupled.
 Minimum Width: 0.1 μ sec.
 Maximum Width: 1 μ sec.
 RF Output: Rise time < 20 nsec, decay time < 20 nsec.
 Continuous Amplitude Modulation: Maximum Frequency: 10 mc, sinusoidal.
 Sensitivity: 8 db to 35 db per volt, for attenuations from 2 db to 30 db.
 Input Impedance: Approximately 500 ohms.
 Level Control: AM input is dc coupled, permitting control by bias of AM input; rear panel control for use with ac coupled modulation.

Trigger Out: Sync Out: 0.1 μ sec to 100 μ sec in advance of rf pulse, as set by Delay control.
 Delayed Sync Out: Simultaneous with rf pulse.
 Amplitude: Approximately 2 v.
 Source Impedance: Approximately 500 ohms.

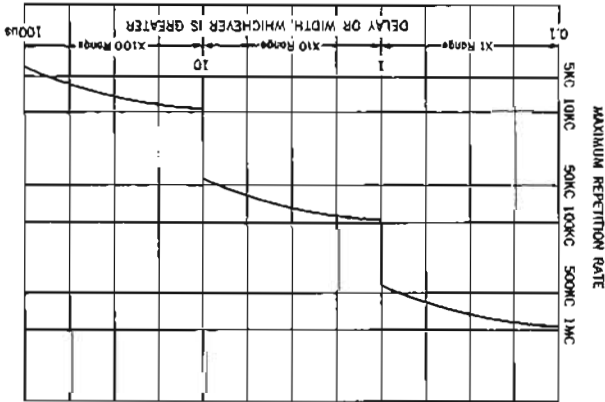

8714A

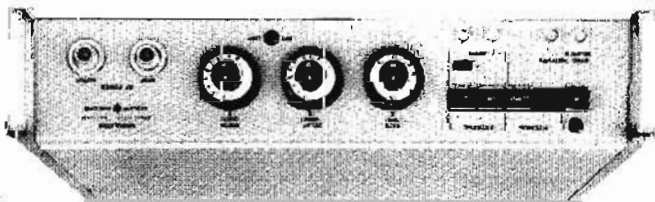

NEW IN THIS CATALOG

NEW IN THIS
CATALOG



DY-2650A

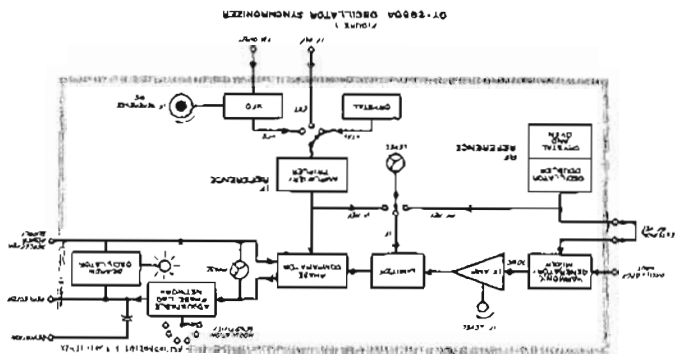

The Dymec DY-2650A Oscillator Synchronizer permits absolute control of frequency by phase locking a klystron oscillator to a crystal reference, achieving short-term stability of 1 part in 10^6 per second, 1 part in 10^8 per week. Temperature stability is 1 part in 10^6 from 0 to 50°C. The synchronizer samples less than 0 dbm of the klystron power. This instrument will stabilize most reflex klystrons, 1 to 12.4 gc, with complete elimination of klystron long term drift and minimization of all incidental FM caused by klystron noise, power supply ripple, and mechanical shock. It can also be used for frequency modulation and control, frequency stability monitoring, and FM monitoring.

DY-2650A is essentially a crystal-controlled superheterodyne receiver terminating in a phase comparator. An oscillator sample is mixed with harmonics of the rf reference to produce an intermediate frequency of 30 mc, which is compared in phase with the 30 mc reference. For stabilizing a klystron, the resultant phase error voltage is added in series with the klystron reflector power supply voltage.

The rf reference frequency is controlled by a quartz crystal, oven-mounted for temperature stabilization. The oven and circuit accommodate a fifth-overtone crystal ground for a frequency between 100 and 120 mc. The harmonics of the internal reference are spaced between 200 and 240 mc apart, depending on the crystal selected. For each harmonic there are two "lock" frequencies, one 30 mc above the harmonic and the other 30 mc below. For a given crystal a number of lock points are therefore available. For example, a 100 mc crystal produces 42 available lock frequencies between 8.2 and 12.4 gc (X-band).

The signal frequencies at which locking will occur with a particular crystal are given by the formula:

$$F_{\text{final}} = 2N F_{\text{xtal}} \pm F_{\text{if}}$$

Where $F_{\text{xtal}} = 100$ to 120 mc
 $F_{\text{if}} = 30$ mc (fixed) or 29 to 31 mc (variable)
 $N = \text{Harmonic number (5 through 62)}$

The combination of a DY-2650A, a klystron and a klystron power supply (such as an hp 716) form an extremely stable microwave signal source. Additionally, the DY-2650A is fully compatible with the hp 8614A and 8616A Signal Generators.

Specifications

Stability (using internal crystals): $1/10^6$ per second, $1/10^8$ per week (over $\pm 5^\circ\text{C}$), $1/10^8$ over range 0 to 50°C.
 Output Circuitry: Suitable for connection to klystron reflector; floating and insulated up to 2000 v dc. A phase lag network provides optimum characteristics for matching klystron sensitivities from 0.05 to 4 mc/volt.
 Input Power: 0 dbm at 12.4 gc. Less at lower frequencies. Maximum power input, ± 20 dbm.
 RF Reference: Provided by internal quartz crystal. Please specify your microwave frequency when ordering.
 External: 200 to 240 mc; 2 volts into 50 ohms. Rear panel BNC.

IF Reference: Quartz crystal 10 mc $\pm 0.001\%$ or VFO tunable 29 to 31 mc by front panel control.
 Internal: Quartz crystal 10 mc $\pm 0.001\%$ or VFO tunable 29 to 31 mc by front panel control.
 External: 29 mc to 31 mc; 0.5 v into 56K. Also 10 mc or 15 mc at higher levels applied at front panel BNC.
 Power: 115 or 230 volts $\pm 10\%$, 50 to 1000 cps, 85 watts.
 Dimensions: 16 3/4" wide, 3 1/4" high, 16 3/8" deep behind panel. Hardware furnished converts unit to 19" wide rack mount.
 Weight: Net 21 lbs. Shipping 35 lbs. approx.
 Price: \$1450 (Supplied with 100 mc rf reference crystal). With special order crystal, \$1480.)
 Data subject to change without notice.

hp 614A, 616B UHF SIGNAL GENERATORS

Direct Reading, Direct Control
800 to 2,100 MC,
1.8 to 4.2 GC

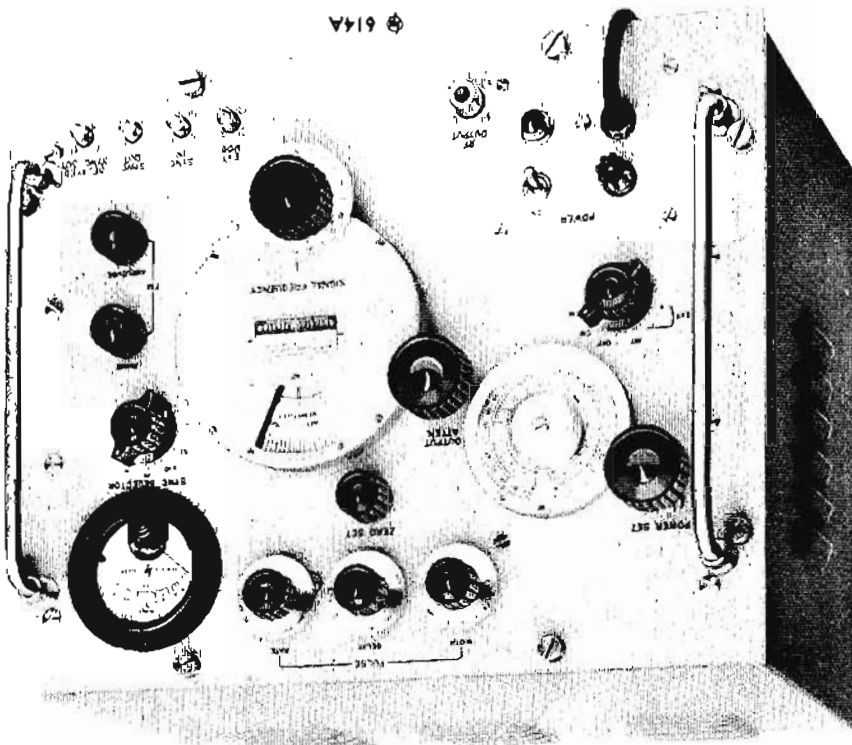

Advantages:

- Direct reading frequency dial
- Direct reading output in microvolts or dbm

- CW, FM or pulsed output

- Versatile pulse capabilities

- Broadband coverage

- High stability

Use To Measure:

- Receiver sensitivity

- Signal-to-noise ratio

- Standing wave ratios

- Antenna gain

- Transmission line characteristics

Base of operation, direct reading without calibration or correction charts, one-dial frequency coverage — all are outstanding advantages of these two widely-used signal generators.

614A covers frequencies from 800 to 2,100 MC, has constant internal impedance with less than 1.6 SWR, and output accuracy of ± 1 db over the range of -10 dbm to -127 dbm.

616B gives complete coverage of frequencies from 1.8 to 4.2 GC, has constant internal impedance with less than 1.8 SWR, and output accuracy of ± 1.5 db from -7 dbm to -127 dbm.

On both instruments, operation is extremely simple. Carrier frequency is set and read directly on the large tuning dial. No voltage adjustments are necessary during operation because of the coupling device which causes oscillator voltage to track frequency changes automatically. Oscillator output is set and read directly on a simplified dial. Output may be continuous or pulsed, or frequency modulated at power supply frequency. Pulse modulation may be synchronized externally or internally. Internal pulsing may be provided with either positive or negative external pulses, or sine waves. The oscillator portion of both the 614A and 616B consists of a reflex klystron in an external coaxial resonator. Frequency of oscillation is determined by a movable plunger which varies the resonant frequency of the resonator. Oscillator output is monitored by a temperature-compensated ther-

Figure 1. Block diagram, Φ 614A/616B Signal Generator.

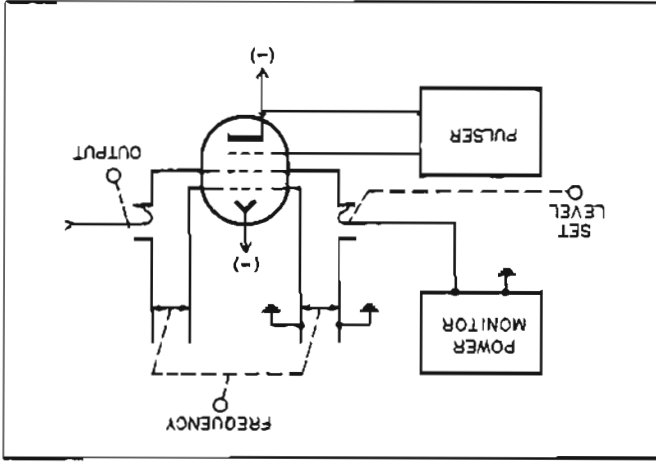

Data subject to change without notice.

Frequency Calibration Accuracy: $\pm 1\%$.
Frequency Stability: $0.005\%/^{\circ}\text{C}$ change in ambient temperature; line voltage changes of $\pm 10\%$ cause less than 0.01% frequency change.
Output Range: 1 milliwatt or 0.223 v to $0.1\text{ }\mu\text{v}$ (0 dbm to -127 dbm) into 50-ohm load. Directly calibrated in microvolts and dbm ; continuously monitored.
Attenuator Accuracy: Within $\pm 1.5\text{ db}$ from -7 dbm to -127 dbm without correction charts.
Internal Impedance: 50 ohms , nominal. SWR less than 1.8.
Modulation: Internal or external pulse or FM.
Internal Pulse Modulation: Repetition rate variable from 40 to $4,000$ per second; pulse length variable from 1 to $10\text{ }\mu\text{sec}$; and delay variable from 3 to $300\text{ }\mu\text{sec}$ (between synchronizing signal and rf pulse).
External Pulse Modulation: Pulse requirements: Amplitude from 40 to 70 v positive or negative, width $1\text{ }\mu\text{sec}$ to $2,500\text{ }\mu\text{sec}$. May be square wave modulated.
Trigger Pulses Out: (1) Simultaneous with rf pulse. (2) In advance of rf pulse, variable 3 to $300\text{ }\mu\text{sec}$. (Both approximately $1.0\text{ }\mu\text{sec}$ rise time, amplitude 10 to 50 volts.)
External Sync Pulse Required: Amplitude from 10 to 50 volts of either positive or negative polarity and 1 to $20\text{ }\mu\text{sec}$ width. May also be synchronized with sine waves.
Frequency Modulation: Oscillator frequency sweeps at power line frequency. Phasing and sweep range controls provided. Maximum deviation approximately 3 MC .
Power: 115 or $230\text{ v} \pm 10\%$, 50 to $1,000\text{ cps}$, 160 watts.
Dimensions: Cabinet Mount: $17\frac{1}{4}''$ wide, $13\frac{3}{8}''$ high, $13\frac{1}{2}''$ deep. Rack Mount: $19''$ wide, $14''$ high, $12\frac{1}{8}''$ deep behind panel.
Weight: Net 58 lbs. Shipping 79 lbs. (cabinet mount). Net 59 lbs. Shipping 80 lbs. (rack mount).
Accessories Furnished: 11500A RF Cable Assembly.
Accessories Available: 360D Low Pass Filter, $\$50.00$. 10503A Video Cable Assembly, $\$6.50$. S281A Waveguide to Coax Adapter, 2.6 to 3.95 GC , $\$50.00$. G281A Waveguide to Coax Adapter, 3.95 to 5.85 GC , $\$40.00$.
Price: Φ 616B, $\$1,950.00$ (cabinet); Φ 616BR, $\$1,970.00$ (rack mount).

A piston attenuator in the power monitor circuit is mechanically coupled to the cursor of the output attenuator dial to compensate for variations in klystron output as frequency is changed. Output power is passed through another identical piston attenuator which is linear over a range of 120 db or more. Because of their wide range and great stability, Φ 614A and 616B Signal Generators are ideal for almost all precision unit measurements. They are compact in size and ruggedly built of highest quality components for long, trouble-free service.

Specifications

Frequency Range: 800 to $2,100\text{ MC}$ directly calibrated.
Frequency Calibration: Accuracy $\pm 1\%$
Frequency Stability: $0.005\%/^{\circ}\text{C}$ change in ambient temperature. Line voltage changes of $\pm 10\%$ cause less than 0.01% frequency change.
Attenuator Range: 0 dbm to -127 dbm (0.223 v to $0.1\text{ }\mu\text{v}$) calibrated directly in volts and dbm .
Attenuator Accuracy: $\pm 1\text{ db}$ from -10 dbm to -127 dbm .
Output Power: At least 0.5 mw into 50-ohm load.
Internal Impedance: 50 ohms . SWR less than 1.6.
Modulation: Internal or external pulse or FM.
Internal Pulse Modulation: Pulse repetition rate variable from 40 to $4,000$ per second; pulse length variable from 1 to $10\text{ }\mu\text{sec}$; delay variable from 3 to $300\text{ }\mu\text{sec}$ between synchronizing signal and rf pulse.
External Pulse Modulation: By external pulses, pos. or neg. peak amplitude 40 to 70 v , width $1.0\text{ }\mu\text{sec}$ to $2,500\text{ }\mu\text{sec}$. May be square wave modulated.
Trigger Pulses Out: (1) Simultaneous with rf pulse. (2) In advance of rf pulse, variable 3 to $300\text{ }\mu\text{sec}$. (Both approximately $1\text{ }\mu\text{sec}$ rise time, amplitude 10 to 50 v .)
External Sync Pulse Required: Amplitude from 10 to 50 v of either pos. or neg. polarity; and 1 to $20\text{ }\mu\text{sec}$ width. May also be synchronized with sine waves.
Frequency Modulation: Oscillator frequency sweeps at power line frequency. Phasing and sweep range controls provided. Max. deviation approx. 3 MC .
Power: 115 or $230\text{ v} \pm 10\%$, 50 to $1,000\text{ cps}$, 150 watts.
Dimensions: Cabinet Mount: $17\frac{1}{4}''$ wide, $13\frac{3}{8}''$ high, $13\frac{1}{2}''$ deep. Rack Mount: $19''$ wide, $14''$ high, $12\frac{1}{8}''$ deep behind panel.
Weight: Net 58 lbs. Shipping 79 lbs. (cabinet mount). Net 59 lbs. Shipping 80 lbs. (rack mount).
Accessories Furnished: 11500A RF Cable Assembly.
Accessories Available: 360C Low Pass Filter, $\$50.00$. 10503A Video Cable Assembly, $\$6.50$.
Price: Φ 614A, $\$1,950.00$ (cabinet); Φ 614AR, $\$1,970.00$ (rack mount).
Frequency Range: 1.8 to 4.2 GC , directly calibrated.

6188

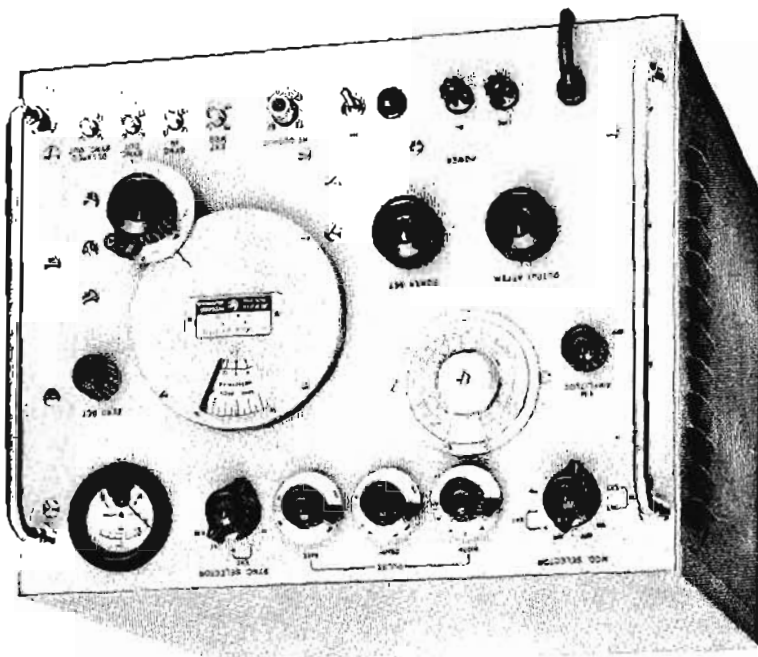

618B, 620A SHF SIGNAL GENERATORS

Multiple Purpose Signal Generators for Measurements 3.8 to 11 GC

Advantages:

- Direct reading frequency dial
- Direct reading output in voltage or dbm
- Internal FM, CW, pulsed or square wave modulation
- Broadband coverage
- Wide frequency range
- High stability, high accuracy

Use To Measure:

- Receiver sensitivity
- Selectivity or rejection
- Signal-to-noise ratio
- Antenna gain
- Transmission line characteristics

Sawtooth Sweep

Hewlett-Packard 618B and 620A shf Signal Generators bring the simple yet versatile operation and the varied pulsing capabilities of 40 uhf Signal Generators to the 3.8 to 11 gc frequency range.

These generators offer internal or external pulse modulation, internal square wave modulation, and FM. The pulse repetition rate is continuously variable from 40 to 4,000 pps, and pulse width is variable from 0.5 to 10 microseconds. Sync out signals are simultaneous with the rf pulse, or in advance of the rf pulse by any time span from 3 to 300 microseconds. The instruments may be synchronized with an external sine wave or with positive or negative pulse signals.

For internal frequency modulation, both 618B and 620A have a saw-tooth voltage variable from 40 to 4,000 cps providing a variable frequency deviation. For external FM, the instruments provide capacitive coupling to the re-peller of the klystron oscillator. Deviation is approximately 2.5 mc.

Both generators maintain the same high standards of accuracy found in 40 uhf and 11 gc Signal Generators. Both also feature the same simple operation. Carrier frequency is

Internal Pulse Modulation: Repetition rate variable from 40 to 4,000 pps, pulse width variable 0.5 to 10 μ sec.

Sync Out Signals: (1.) Simultaneous with rf pulse—positive (2.) In advance of rf pulse—positive, variable 3 to 300 μ sec. (Better than 1 μ sec rise time and 25 to 100 volts amplitude into 1,000 ohm load.)

External Synchronization: (1.) Sine wave: 40 to 4,000 cps, amplitude 5 to 50 volts rms. (2.) Pulse signals: 0 to 4,000 pps and 5 to 50 volts amplitude, both positive and negative, pulse width 0.5 to 5 μ sec, rise time 0.1 to 1 μ sec.

Internal Square Wave Modulation: Variable 40 to 4,000 cps, controlled by "pulse rate" control.

Internal Frequency Modulation: Saw-tooth sweep rate adjustable between 40 and 4,000 cps. Maximum frequency deviation approx. 2.5 mc over most of the band.

External Pulse Modulation: Pulse requirements: amplitude from 20 to 70 volts positive or negative, width 0.5 to 2,500 μ sec.

External Frequency Modulation: Provides capacitive coupling to repeller of klystron. Maximum deviation approximately 2.5 mc over most of the band.

Power: 115 or 230 v \pm 10%, 50 to 60 cps, 250 watts.

Dimensions: Cabinet Mount: 17 1/2" wide, 14" high, 19 1/2" deep. Rack Mount: 19" wide, 14" high, 17 3/8" deep behind panel.

Weight: Net 95 lbs. Shipping 119 lbs. (cabinet mount). Net 96 lbs. Shipping 119 lbs. (rack mount).

Accessories Furnished: 11500A Cable Assembly.

Accessories Available: 10503A Video Cable Assembly, \$6.50. 11001A Cable Assembly, \$5.50.

Price: Φ 618B, \$2,250.00 (cabinet); Φ 618BR, \$2,270.00 (rack mount).

Φ 620A

(Same as Φ 618B except as follows:)

Frequency Range: 7 to 11 gc covered in a single band. Repeller voltage automatically tracked and proper mode automatically selected.

Output Accuracy: Within \pm 2 db from -7 dbm to -127 dbm; within \pm 3 db from 0 to -7 dbm, at panel connector, terminated in 50 ohm load.

Price: Φ 620A, \$2,250.00 (cabinet); Φ 620AR, \$2,270.00 (rack mount).

Data subject to change without notice.

Calibration: Direct reading. Frequency calibration accuracy better than 1%.

Frequency Stability: Frequency variation less than 0.006% per degree centigrade change in ambient temperature. Line voltage change of \pm 10% causes less than 0.02% frequency change.

Output Range: 1 milliwatt or 0.223 volt to 0.1 microvolt (0 dbm to -127 dbm) into 50 ohms. Directly calibrated in microvolts and db (coaxial Type N connector).

Output Accuracy: Within \pm 2 db -7 dbm to -127 dbm, within \pm 3 db 0 to -7 dbm at the end of 6 ft. output cable, terminated in 50-ohm load.

Internal Impedance: 50 ohms nominal, SWR less than 2.

Modulation: Internal or external pulse, FM, square wave.

Specifications Φ 618B

The 618B and 620A Generators both feature oscillators of the reflex klystron type, with external resonant cavity. Oscillator frequency is determined by a movable plunger which varies the length of the cavity. Oscillator output is monitored by a temperature-compensated thermistor bridge circuit. This circuit operates virtually unaffected by ambient temperature conditions. Identical piston attenuators couple power to the monitor and output terminal. The power monitor attenuator is linked to the output attenuator cursor to compensate for klystron output variation as frequency is changed.

Models 618B and 620A are designed to be the most broadly useful, accurate and dependable signal generators available in their frequency ranges. Their high stability, broad frequency coverage, precision accuracy and varied pulsing capabilities make them ideal for virtually all measurement requirements requiring precisely known and controllable signals. They are sturdily built of the best components, many parts being specially manufactured for or by Hewlett-Packard. Circuitry is clean and accessible. The generators are designed for years of dependable service with little or no maintenance.

hp 626A/628A 9HF SIGNAL GENERATORS

Direct Reading, High Power
10 to 15.5 GC,
15 to 21 GC

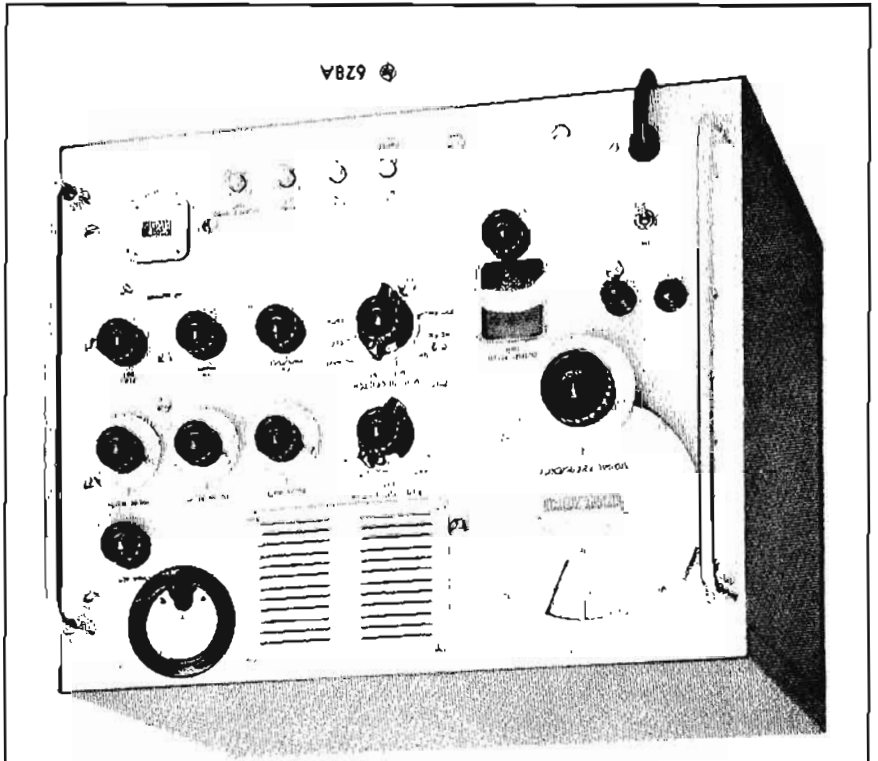

Advantages:

- Direct reading frequency control
- Direct reading output control
- 10 mw output over full range
- CW, FM or pulse modulation
- Internal square wave modulation
- Broad pulsing capabilities
- Low internal SWR
- High stability
- Operates to 40 GC with 628/940 Frequency Doubler Sets

Use To Measure:

- Receiver sensitivity
- Selectivity or rejection
- Signal-to-noise ratio
- Transmission line characteristics

Here are two 9HF signal generators which extend the measuring versatility, convenience and accuracy of 9HF signal generators to 21 GC. The 626A covers frequencies 10 to 15.5 GC, and the 628A covers frequencies 15 to 21 GC. In design and operation, the instruments are similar to 9HF generators for lower frequency ranges. Operation is very simple. Carrier frequency is set and read directly on the large tuning dial. No voltage adjustment is necessary during tuning because repeller voltage is tracked with frequency changes automatically. Oscillator output is also set and read directly, and no frequency correction is necessary throughout operating range. A frequency logging scale permits frequency to be reset within 0.1%.

The high power output of these signal generators make them ideally suited for driving 938A and 940A Frequency Doubler Sets (18 to 26.5 GC and 26.5 to 40 GC respectively). These Doubler Sets (see pages 226, 227) retain the modulation and stability of the driving source and have accurate power monitors and attenuators.

Versatile Modulation

Both 626A and 628A offer internal and external pulse modulation as well as internal squarewave modulation and

Specifications

Frequency Ranges: 626A, 10 to 15.5 GC; 628A, 15 to 21 GC.

Frequency Calibration: Dial direct reading in gigacycles. Accuracy better than $\pm 1\%$.

Output Range: 10 mw to 1 pw. (+10 dbm to -90 dbm, 0 dbm = 1 mw.) Attenuator dial directly calibrated in output dbm. SWR less than 2.5 at +10 dbm; 1.2 at 0 dbm and lower.

Output Monitor Accuracy: Better than ± 1 db.

Output Attenuator Accuracy: Better than $\pm 2\%$ of attenuation in db introduced by output attenuator.

Leakage: Less than minimum calibrated signal generator output.

Modulation: Internal or external pulsed, FM, or square wave.

Internal Pulse Modulation: Repetition rate variable from 40 to 4,000 pps. Pulse width variable 0.5 to 10 μ sec.

Internal Square Wave Modulation: Variable 40 to 4,000 cps controlled by "pulse rate" control.

Internal Frequency Modulation: Power line frequency, deviation up to 5 MC.

External Pulse Modulation: Pulse Requirements: Amplitude 15 to 70 volts peak positive or negative; width 1.0 to 2,500 μ sec.

External Frequency Modulation: Provided by capacitive coupling to repeller of klystron. Maximum deviation approximately 5 MC.

Sync Out Signals: Positive 20 to 50 volts peak into 1,000 ohm load. Better than 1 μ sec rise time.

(1) Simultaneous with rf pulse.
 (2) In advance of rf pulse, variable 3 to 300 μ sec.

External Synchronization: (1) Sine wave, 40 to 4,000 cps, amplitude 5 to 50 volts rms.
 (2) Pulse signals 0 to 4,000 pps, 5 to 50 volts amplitude, positive or negative. Pulse width 0.5 to 5 μ sec. Rise time 1 μ sec or less.

Power: 115 or 230 v $\pm 10\%$, 50 to 60 cps, approx. 200 watts. Dimensions: Cabinet Mount: 17" wide, 14" high, 15" deep. Rack Mount: 19" wide, 14" high, 12-13/16" deep behind panel.

Weight: 626A, Net 65 lbs. Shipping 80 lbs. (cabinet); 626AR, Net 65 lbs. Shipping 82 lbs. (rack mount); 628A, (cabinet), 628AR (rack mount), Net 63 lbs. Shipping 77 lbs.

Accessories Furnished: 626A (a) MX 292B Waveguide Adapter, WR-75 to WR-90 guide. (b) MP 292B Waveguide Adapter, WR-75 to WR-62 guide.

628A (a) NP 292A Waveguide Adapter, WR-51 to WR-62 guide. (b) NK 292A Waveguide Adapter, WR-51 to WR-42 guide.

Accessories Available: 10503A Video Cable Assembly, \$6.50. For 626A: M362A Low Pass Filter, \$350.00. For 628A: N362A Low Pass Filter, \$350.00.

Price: 626A or 628A, \$3,400.00 (cabinet). 626AR or 628AR, \$3,420.00 (rack mount).

FM. Pulse repetition rate is continuously variable from 40 to 4,000 pps, and pulse width is variable from 0.5 to 10 μ sec. Sync out signals are simultaneous with the rf pulse, or in advance of the rf pulse by any time span from 3 to 300 μ sec. The pulse generators may be synchronized with an external sine wave and also with positive or negative pulse signals.

For internal FM, both instruments feature a sine wave sweep at power line frequency. Frequency deviation is variable up to 5 MC. For external FM, the generators have capacitive coupling to the klystron oscillator repeller.

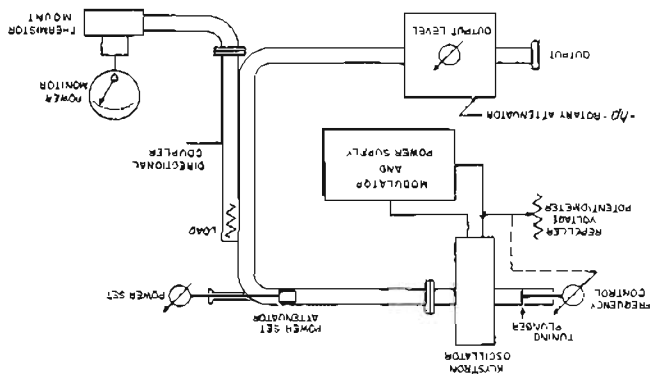
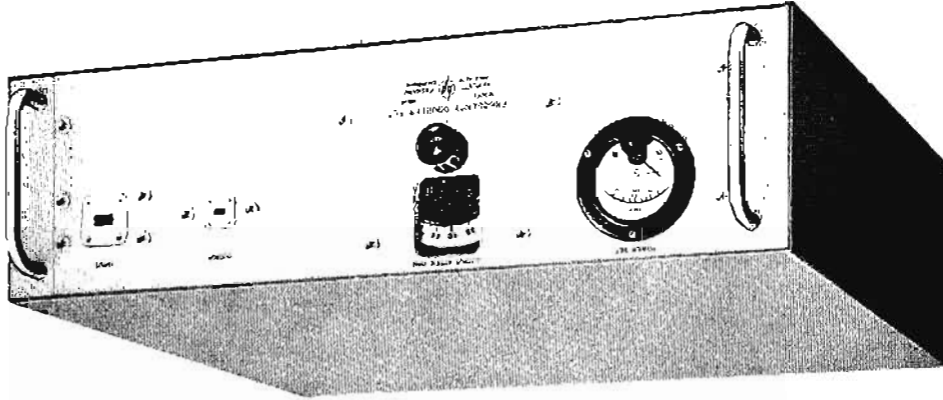

Figure 1. Basic circuit, 626A/628A.

Figure 1 shows the basic circuits of the signal generators. The reflex klystron oscillator is tuned by a plunger driven by the direct-reading frequency dial and control. Repeller voltage is automatically tracked so that correct operating potentials are maintained over the entire frequency range. Klystron output is introduced into a power monitoring directional coupler through an attenuator which is adjusted to provide a fixed reading on the power monitoring meter. The directional coupler provides uniform coupling over the entire frequency range. A rotary attenuator which follows the coupler assures high accuracy and stability because the attenuation is governed by a precise mathematical law related to the angular rotation of the attenuator. The conductivity of the attenuating film does not affect the attenuation; thus the output of the generator is independent of humidity, temperature or the effects of long term aging. The attenuator also provides low SWR over the complete frequency range. On both 626A and 628A, the output connector is waveguide. Adapters furnished permit the instrument to be connected to WR-42, WR-62 or WR-90 waveguide. Thus the generators can be employed with all EIA (RETM-A) and JAN guides suitable for the 10 to 21 GC range.

Data subject to change without notice.



hp 938A, 940A FREQUENCY DOUBLER SETS

Generate Stable Signals to 40 GC with These Precision Instruments

Uses:

Microwave power generation in K- and R-bands, 18 to 40 gc

Useful for testing waveguide components

Sweep frequency reflectometer applications in K- and

R-bands

Receiver sensitivity measurements

In the frequency region of 20 to 40 gc, no microwave

oscillators exist today which cover entire waveguide bands

known. Therefore, the hp 938A and hp 940A Frequency

Doublers were developed to extend the frequency ranges of

hp signal generators into this important region. The combina-

tion of doubler and generator retains all the excellent stabl-

ity characteristics of the lower frequency generators.

The hp 938A, 940A Frequency Doubler Sets may be used

with a wide variety of existing signal sources or one of the

hp signal generators or sweep oscillators described in this

catalog. Model 938A supplies power from 18 to 26.5 gc

when driven by a 9 to 13.25 gc source. Model 940A sup-
plies power from 26.5 to 40 gc when driven by a 13.25 to
20 gc source.

Each contains a broadband crystal-harmonic generator,

a power monitor, and a dual rotary vane attenuator, for

generating and accurately setting the output level.

Output power depends on input power and is typically

0.5 to 1.0 mw when the driving source is an hp 626A or

628A Signal Generator or an hp 686C or 687C Sweep Os-

cillator. Output power is known, even though an uncali-

brated signal is used, since the output monitor is accurate

to ± 2 db.

Typical of the output versatility of these frequency doubler

sets is the fact that an hp 938A driven by an hp 626A will

provide cw output, pulse modulated output with a repetition

rate from 40 to 4000 pps, square-wave modulated output

with modulation frequencies from 40 to 4000 cps, or 60 cps

fm output. In addition, pulsed output may be synchronized

with external signals or output may be externally pulse or

frequency modulated.

Data subject to change without notice.

Complementary Equipment: *hp* 626A and 628A Signal Generator, *hp* 687C Electronic Sweep Oscillator.
 Price: \$1500 (cabinet); \$1515 (rack mount).
 11516A, \$40.
 R-Band Circular Flange Adapters (UG-381/U), *hp* \$40 each; *hp* 11503A P-Band Flexible Waveguide, \$48, NK292A, (one each furnished with *hp* 628A); MP292B, Accessories Available: Waveguide Adapter NP292A, lbs. (cabinet), 33 lbs. (rack mount).
 Weight: Net 20 lbs. (cabinet or rack mount). Shipping 35 lbs. (cabinet), 33 lbs. (rack mount).
 Dimensions: 5" high, 19" wide, 18" deep.
 waveguide R-band.
 Output Flange: UG-599/U flat cover flange for WR-28 waveguide.
 Input Flange: N-Band flat cover flange for WR-51 waveguide.
 Output SWR: Approx. 2.5 at full output. Less than 1.5 with attenuator set to 10 db or more attenuation.
 Attenuator Range: 100 db.
 Output Attenuator Accuracy: $\pm 2\%$ of reading or ± 0.2 db, whichever is greater.
 Output Monitor Accuracy: ± 2 db.
 Maximum Input Power: 100 mw.
 Input Power Required: 10 mw design center.
 628A Signal Generator.
 imately 0.5 to 1 mw when used with typical *hp* 626A or
 Output Power: Depends on input power supplied. Approx.
 Conversion Loss: Less than 18 db at 10 mw input.
 Frequency Range: 26.5 to 40 gc.

Model 940A Frequency Doubler Set

Frequency Range: 26.5 to 40 gc.
 Conversion Loss: Less than 18 db at 10 mw input.
 Output Power: Depends on input power supplied. Approx.
 imately 0.5 to 1 mw when used with typical *hp* 626A or
 628A Signal Generator.
 Input Power Required: 10 mw design center.
 Maximum Input Power: 100 mw.
 Output Monitor Accuracy: ± 2 db.
 Output Attenuator Accuracy: $\pm 2\%$ of reading or ± 0.2 db, whichever is greater.
 Attenuator Range: 100 db.
 Output SWR: Approx. 2.5 at full output. Less than 1.5 with attenuator set to 10 db or more attenuation.
 Input Flange: N-Band flat cover flange for WR-51 waveguide.
 Output Flange: UG-599/U flat cover flange for WR-28 waveguide.

Output Flange: UG-599/U flat cover flange for WR-42 waveguide (K-band).
 Input Flange: M-Band flat cover flange for WR-75 waveguide.
 Output SWR: Approx. 2.5 at full output. Less than 1.5 with attenuator set to 10 db or more attenuation.
 Attenuator Range: 100 db.
 Output Attenuator Accuracy: $\pm 2\%$ of reading or ± 0.2 db, whichever is greater.
 Output Monitor Accuracy: ± 2 db.
 Maximum Input Power: 100 mw.
 Input Power Required: 10 mw design center.
 Signal Generator.
 0.5 to 1 mw when used with typical *hp* Model 626A
 Conversion Loss: Less than 18 db at 10 mw input.
 Output Power: Depends on input power supplied. Approx.
 Frequency Range: 18 to 26.5 gc.

Model 938A Frequency Doubler Set

Frequency Range: 18 to 26.5 gc.
 Conversion Loss: Less than 18 db at 10 mw input.
 Output Power: Depends on input power supplied. Approx.
 0.5 to 1 mw when used with typical *hp* Model 626A
 Signal Generator.
 Input Power Required: 10 mw design center.
 Maximum Input Power: 100 mw.
 Output Monitor Accuracy: ± 2 db.
 Output Attenuator Accuracy: $\pm 2\%$ of reading or ± 0.2 db, whichever is greater.
 Attenuator Range: 100 db.
 Output SWR: Approx. 2.5 at full output. Less than 1.5 with attenuator set to 10 db or more attenuation.
 Input Flange: M-Band flat cover flange for WR-75 waveguide.
 Output Flange: UG-599/U flat cover flange for WR-42 waveguide (K-band).

Specifications

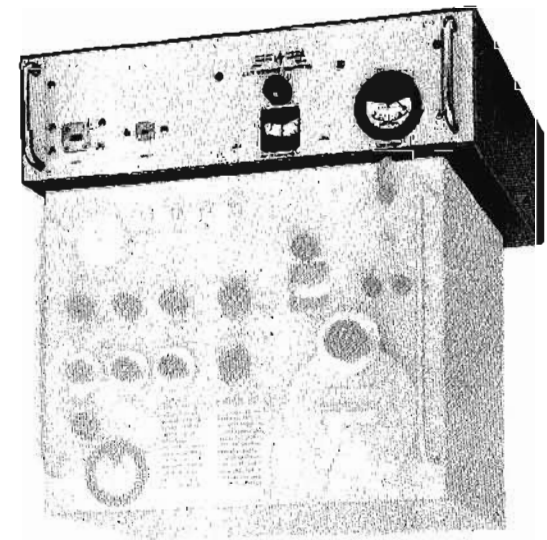

Model 940A and Model 628A

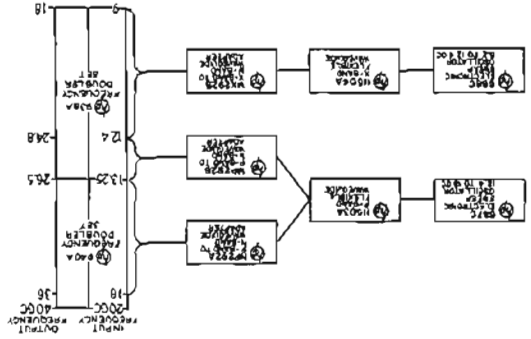

Figure 1. Driving sources, swept frequency.

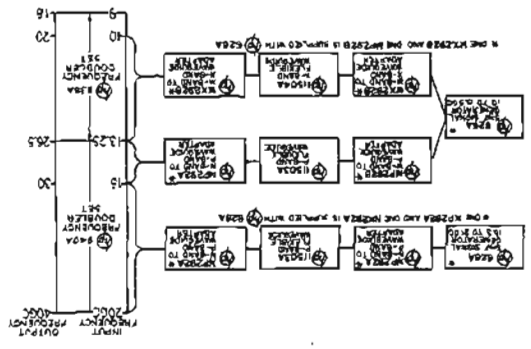

Figure 2. Driving sources, single frequency.

Swept frequency output may be obtained by driving the frequency doubler set with an *hp* 686C or 687C (see pages 228, 229). The 686C and the 687C provide a simple, flexible, broadly adjustable electronic sweep. Multiplying the sweep oscillator settings by 2 yields sweep rate and width. Both sweep width and rate of change of frequency are independently controlled. CW or swept rf frequencies may be obtained over any part of the range, and sweep width may be adjusted instantly without interrupting operation.

HP 682C-687C ELECTRONIC SWEEP OSCILLATORS

Electronic Sweeping for Simple, Comprehensive Full-Band Measurements

Advantages:

- Electronic sweep
- 1 to 18 GC
- Simple to operate, direct reading
- Continuously adjustable sweep width and rate
- 10 mw output minimum
- Frequency sweep linear with time
- Slow sweep for mechanical recorders; fast sweep for non-bickering oscilloscope presentation
- Single sweep manually started or externally triggered
- External FM or AM

Uses:

- Convenient source of cw and swept rf frequencies for:
- Reflectometer measurements
- Slotted line measurements
- Antenna checks
- Transfer characteristics of:
- Networks
- Filters
- Attenuators
- Amplifiers
- Ferrite devices

A unique means is used to achieve a swept frequency that is a linear function of time. Output frequency of a backward wave oscillator tube is an exponential function of the voltage applied to its helix, so by making the sweep voltage applied to the helix the proper exponential function of time, a frequency sweep results which is linear.

Linear Frequency Sweep

With these instruments, you have complete freedom of sweep combination—both sweep width and rate of change of frequency (sweep rate) are independently controlled and direct reading. CW or swept rf frequencies may be obtained over any part of the range; sweep width may be adjusted instantaneously without interrupting operation. The full range can be covered in periods slow enough for high resolution mechanical recording or fast enough for bickeringless oscilloscope presentation (see *Specifications*). Sweep rate is adjustable in nine steps over various ranges as indicated under *Specifications*.

Hewlett-Packard offers six backward-wave sweep oscillators that eliminate sweep motors, tuning plungers, previous range limitations and mechanical problems . . . and cover all or part of a given band with a simple, flexible, broadly adjustable, quiet electronic sweep!

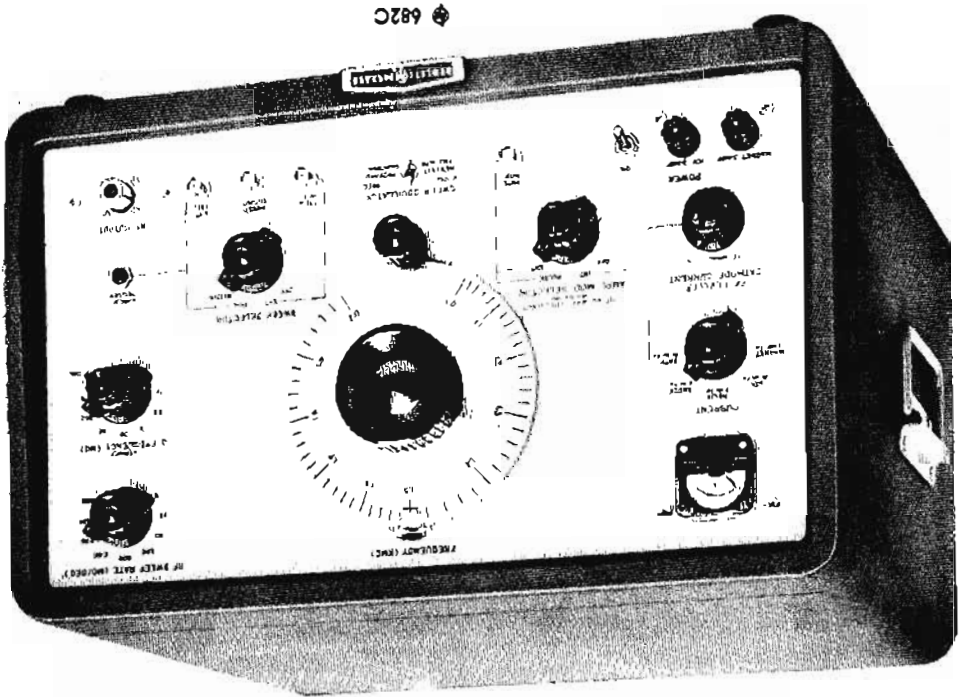

682C

Weight: Net 105 lbs. Shipping 134 lbs.
 Dimensions: Width 20 - 9/16", height 12 3/4", depth 18" (cabinet). Width 19", height 10 1/2", 16 1/2" deep behind panel (rack mount).
 Power: 115 or 230 volts \pm 10 %, 50 to 60 cps, approximately 540 watts.
 External Pulses: \pm 10 volts or greater pulse required; 5 millisecond maximum pulse length. Peak rf pulse level within 1 db of cw setting. Pulse rise and decay times less than 1 μ sec. Input impedance: 390,000 ohms shunted by 25 pF; ac coupled.
 Modulating Voltage must be decreased with modulating frequencies higher than 60 cps. Input impedance: 43,000 ohms shunted by 100 pF; ac coupled.
 External FM: Approximately 150 volts peak-to-peak required to modulate full frequency range of instrument for modulating frequencies 10 cps to 60 cps. Modulating voltage must be decreased with modulating frequencies higher than 60 cps. Input impedance: 43,000 ohms shunted by 100 pF; ac coupled.
 Internal AM: Square wave modulation continuously adjustable from 400 - 1200 cps; peak rf output power is within 1 db of the cw setting.
 External AM: Direct coupled dc to several MC; \pm 20 volts or more reduces rf output level from rated cw output to zero. Input impedance: 750,000 ohms, 25 pF shunt.

Modulation:
 Residual AM: Less than \pm 40 db.
 Dial Accuracy: \pm 1%.
 Maximum SWR: 3 or less for H01 686C and 686C, 2 or less for H01 687C, 2 or less for other models.
 Power Output: 682C, 50 mw; 683C, 30 mw; other models 10 mw or more into load (50 ohms for Type N output) having an SWR of 1.25 or less. Output continuously adjustable to zero.
 Sweep Mode: Recurrent; externally triggered; manually triggered. RF frequency sweep is linear with respect to time and is downward from frequency dial setting. Sweep Output: \pm 25 volt (approx.) peak sawtooth provided concurrently with swept rf output for recorder and oscilloscope sweeping. Source impedance approximately 10,000 ohms and 20 pF in parallel.
 Power Output: 682C, 50 mw; 683C, 30 mw; other models 10 mw or more into load (50 ohms for Type N output) having an SWR of 1.25 or less. Output continuously adjustable to zero.

For All Models:

with leveler operating.

Model	Freq. GC	Sweep Range	Rate of Change	Sweep Time	Output Power	Residual FM	Spurious Signals	Output Connector	Price	Cabinet
682C	1.1 MC to 1.1 GC	seven steps, continuous	8 MC/sec to 80 GC/sec in nine steps	0.0137 sec to 137 sec determined by sweep, range and rate	Less than \pm 1.5 db over entire frequency range	Less than 50 KC pk	Less than -20 db	Type N (Female)	\$3,075	
683C	2.1 MC to 2.1 GC	seven steps, continuous	16 MC/sec to 160 GC/sec in nine steps	0.0132 sec to 132 sec determined by sweep, range and rate	Less than \pm 1.5 db over entire frequency range	Less than 100 KC pk	Less than -20 db	Type N (Female)	\$2,985	
684C	4.1 MC to 4.1 GC	seven steps, continuous	32 MC/sec to 320 GC/sec in nine steps	0.0135 sec to 135 sec determined by sweep, range and rate	Less than \pm 2 db over entire frequency range	Less than 200 KC pk	Less than -20 db	Type N (Female)	\$2,985	
H01	4.1 MC to 4.1 GC in seven steps, continuous	control between steps	32 MC/sec to 320 GC/sec in nine steps	0.0135 sec to 135 sec determined by sweep, range and rate	Less than \pm 1.5 db over entire frequency range	Less than 200 KC pk	Less than -30 db	Type N (Female)	\$2,985	
686C	4.4 MC to 4.4 GC	seven steps, continuous	32 MC/sec to 320 GC/sec in nine steps	0.0139 sec to 139 sec determined by sweep, range and rate	Less than \pm 1.25 db over entire frequency range	Less than 200 KC pk	Less than -30 db	X-band cover Range (UG-136/U)	\$2,885	
687C	6 MC to 6 GC	seven steps, continuous	44 MC/sec to 440 GC/sec in nine steps	0.0136 sec to 136 sec determined by sweep, range and rate	Less than \pm 1.5 db over entire frequency range	Less than 200 KC pk	Less than -30 db	P-band cover Range (UG-419/U)	\$3,385	

Specifications

For greatest convenience the sweep may be operated recurrently, triggered manually by means of a pushbutton or by an externally generated voltage for operation of the instrument in synchronization with other equipment. To facilitate oscilloscope and mechanical recordings, a 25 volt peak sawtooth sweep voltage concurrent with the frequency sweep is supplied at a front panel connector. This sawtooth sweep voltage has a fly-back so short that no blanking signal is required during oscilloscope retrace.

Broad Modulation Capabilities

In addition to their swept frequency output, the oscillators may be internally or externally amplitude modulated, externally pulse modulated and externally frequency modulated. *Internal amplitude modulation* is produced by a square wave variable 400 to 1,200 cps. During modulation, peak rf power is within 1 db of unmodulated cw output.

External amplitude modulation is produced by a signal amplifier. Pass band of this amplifier is dc to several MC, and \pm 20 volts or more reduces the output level from rated to zero. Pulse modulation is also available. In this case there is no output from the instrument except during the pulse. The peak pulse power will be equal to the cw level if the input pulse is 10 volts peak or larger. Pulses up to 5 milliseconds long may be used for this modulation.

Frequency modulation is achieved by varying with externally generated signals the voltage supplied to the helix of the backward wave tube. These signals are capacitively coupled to the helix modulator. When FM'd externally in this manner, the instrument's frequency deviation is both above and below the frequency set on the main tuning dial.

DYMEC MODEL DY-623B, 5636, 624C RF TEST SETS

For Testing Transmitters, Receivers, Communications Systems

Each of these Dymec instruments consists of a combination signal generator, frequency meter and power meter and permits measurement of receiver sensitivity and selectivity, transmitter tuning and power level. Each is easy to use, fast and accurate.

The DY-623B SHF Test Set is suitable for testing complete communications and video relay station equipment in the range 5925 to 7725 mc, using 3 klystrons. It can be frequency modulated from an internal source or pulse modulated from an external source, as can the DY-5636.

The DY-5636 H-Band Test Set more than covers the entire government communications band, 7125 to 8400 mc and offers higher power than the DY-623B, permitting testing of receivers through directional couplers.

The DY-624C X-Band Test Set is designed for testing complete radar or fire control systems or radar beacon equipment. It covers the frequency range of 8500 to 10,000 mc. The DY-624C can be frequency or pulse modulated from an internal or external source.

Specifications	DY-4238	DY-5636	DY-624C
Frequency Range	5925-6575 mc or 6575-7175 mc or 7100-8500 mc	8500-10,000 mc	8500-10,000 mc
Frequency Meter Range	5820-7780 mc	7100-8500 mc	8500-10,000 mc
Output Attenuator Range	0 dbm (1 mw) to 15 dbm (30 mw)	0 dbm (1 mw) to 100 db	0 dbm (1 mw) to 100 db
Internal Modulation	FM, 1 kc	FM, 1 kc	FM, 1 kc
External Modulation	FM, pulse, square-wave, 30 cps to 100 kc	FM, pulse, square-wave, 30 cps to 100 kc	FM, pulse, square-wave, 30 cps to 100 kc
Power Measurement Range (CW)	-6 to +3 dbm	-6 to +40 dbm	-6 to +28 dbm
Panel Height	1 1/2 inches	4 inches	10 1/2 inches
Price	\$2100 (Transit case)	\$3800 (Transit case)	\$2265 (Cabinet) \$2250 (Rack mount)

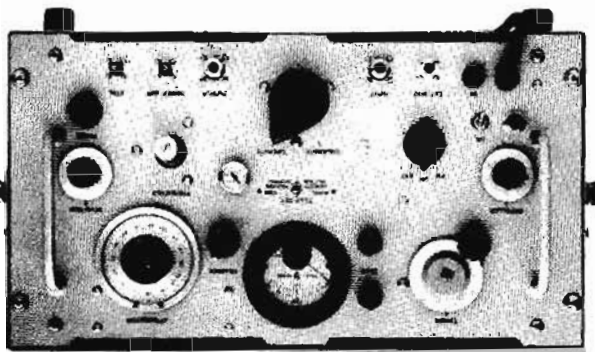

DY-623B

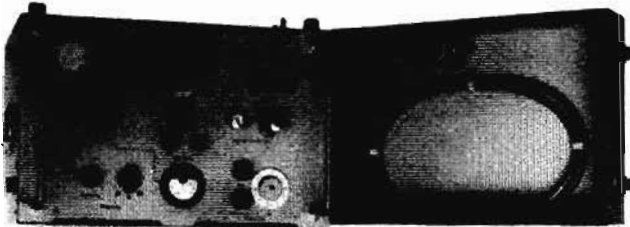

DY-5636

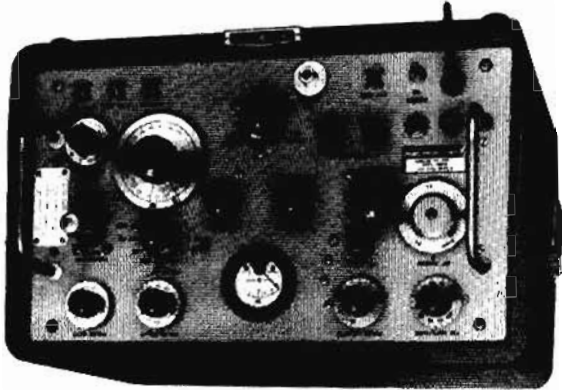

DY-624C

Because the three terms described above are scalar in nature, they describe only the magnitude of reflections. If the exact load impedance must be determined, a slotted line is generally used to determine the positions of the maximum and minimum of the standing wave in addition to the SWR. Then the load is replaced by a short circuit, and the shift of the minimum is recorded. This information can be entered on a Smith Chart to determine the exact magnitude and phase of the load impedance.

When making slotted line measurements, errors may be caused by probe loading, generator mismatch, detector characteristics, harmonics and fm or other spurious signals. Proper measurement techniques which are described in many sources including the Hewlett-Packard Journal, Volume 3, Numbers 1 and 2 will help eliminate or minimize the errors resulting from these sources.

When making measurements below 500 mc, slotted lines become exceedingly long, and other techniques are usually used to determine impedance. At these lower frequencies, the Hewlett-Packard Model 803A VHF Bridge shown in Figure 2 provides a convenient method for making direct measurements of both magnitude and phase angle of load impedances.

There is no linear relationship between the three commonly used terms described above. Their mathematical relationship is:

$$SWR = \frac{1 + p}{1 - p}$$

where SWR = standing wave ratio

p = magnitude of reflection coefficient.

$$\text{return loss} = -20 \log_{10} p$$

The *Reflection Coefficient Calculator* shown in Figure 1 is available on request from Hewlett-Packard. It is a convenient



Figure 1. The Reflection Coefficient Calculator makes rapid conversions between SWR, reflection coefficient and return loss. It also shows rapid conversions between SWR, reflection coefficient and return loss. Basic techniques for making these measurements are described on pages 164 to 167.

slide-rule-type device for making rapid conversions between SWR, reflection coefficient and return loss. Basic techniques for making these measurements are described on pages 164 to 167.

Measurement of standing wave ratio, usually referred to as SWR, is one of the most useful techniques in microwave work. A great deal of useful information about the load and the transmission system can be determined from SWR measurements made at various points in the system.

Reflected voltage from line irregularities or imperfect terminations adds vectorially with the incident voltage to cause standing waves on the line. SWR is the ratio of the maximum voltage to the minimum voltage in the standing wave along the transmission line.

SWR is normally determined by inserting a detector probe into a slotted section of transmission line. The detected energy is measured on a specially calibrated meter, such as the Hewlett-Packard 415 series, which provides a normalized indication so that SWR can be read directly without making additional arithmetic calculations.

Reflection coefficient and return loss are two other terms commonly used to describe the magnitude of reflections on a transmission line. Reflection coefficient is the ratio of the magnitude of the reflected voltage to the magnitude of the incident voltage and is expressed as either a decimal ratio or a percentage. Return loss is simply the reflection coefficient expressed in decibels, rather than as a simple ratio. Return loss is often a more convenient term to use than reflection coefficient—because microwave voltages are difficult to measure directly and are often determined through comparison techniques using precision attenuators or square law devices.

Reflection coefficient can be determined easily by using directional couplers to separate the incident and reflected signals in a reflectometer system. In a reflectometer system both reflection coefficient and return loss can be measured and displayed directly on properly calibrated meters. Thus, slotted lines and SWR meters are used to make direct measurements of SWR, while reflectometers measure reflection coefficient or return loss directly.

Figure 2. The simple hp equipment setup shown here will measure the source impedance of the hp 345B IF Noise Source.

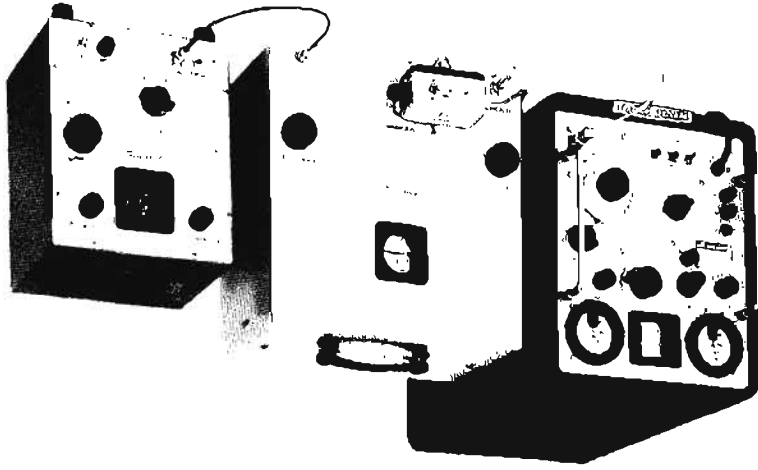

hp 750, 752, 774D, 775D, 776D, 777D DIRECTIONAL COUPLERS

Easy-to-Use, Precision Couplers Simplify Microwave Measurements

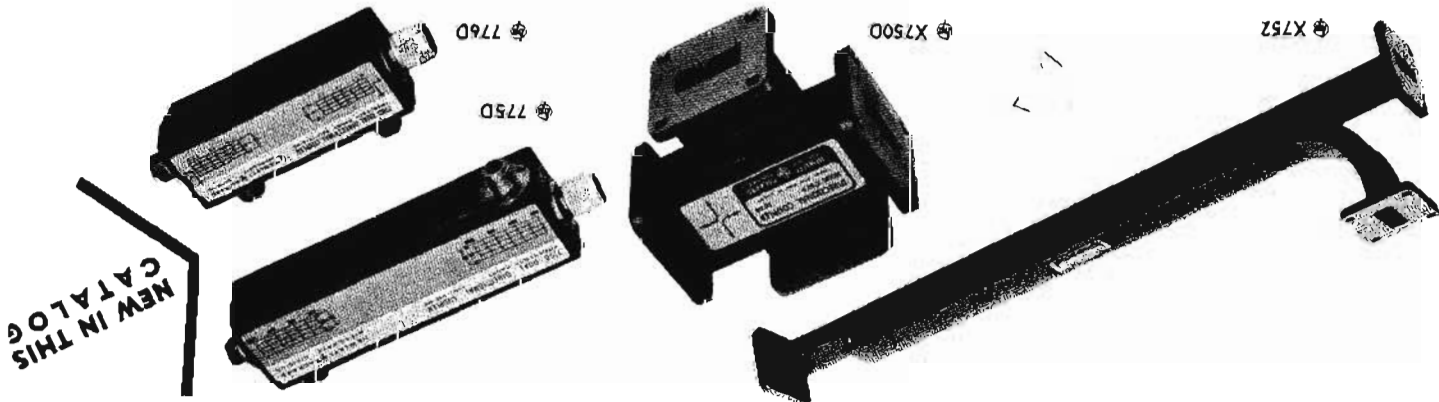

For broadband reflectometer applications (see pages 164-167 for discussion of reflectometer measurements).

hp 750 Cross-Guide Coupler

For many applications the precision multi-hole coupler is not required. An inexpensive and compact instrument suited to numerous laboratory tests is the *hp 750* Cross-Guide Coupler. It consists of two waveguide sections joined at right angles across their broad faces. Coupling factors of 20 or 30 db are available, and connections may be made to both ends of the main and auxiliary guides. This provides a "four-port" network of maximum usefulness and versatility. The unit is well suited for power monitoring, for isolation and mixing powers.

hp 774D, 775D, 776D, 777D Dual Directional Couplers

Because of their high directivity, these dual directional couplers are ideal for reflectometer applications in coaxial systems. Dual couplers are more accurate for reflectometer measurements because the connector reflections between the forward and reverse arm are virtually cancelled. Uncanceled reflections have a tendency to reduce measurement accuracy. The 770 series couplers are also capable of materially improving the speed and accuracy of power measurements on coaxial vhf/uhf systems because of their accurate coupling attenuation characteristics and low swr over relatively wide frequency ranges.

The couplers are specifically designed to furnish maximum versatility and ease in use. Each covers a frequency spread of more than two-to-one, and its coverage is centered on one of the important vhf/uhf bands. The units are capable of handling fairly high amounts of power and have a low in-section loss so that they can be permanently installed in coaxial lines for power monitoring. Since they are dual devices, a power meter or detector can be alternately connected to the "incident" and then to the "reflected" secondary terminals to aid in system adjustment for maximizing forward power. The couplers are equipped with modified Type N connectors which minimize connector swr when mated with standard Type N connectors.

Data subject to change without notice.

Directional couplers such as the *hp 750* and *752* are important tools in waveguide measurements. They may be used to monitor power, measure reflections, mix signals or isolate signal sources or wavemeters.

In addition, the *hp 774D*, *775D*, *776D* and *777D* are dual directional couplers ideal for reflectometer applications in coaxial systems.

Ideally, with the *750* and *752*, power flowing in one (the forward) direction of the main waveguide is coupled to the output of the auxiliary guide, while power flowing in the other (reverse) direction is not coupled to the output of the auxiliary guide. The ratio, expressed in db, of forward power in the main guide to the power out of the auxiliary guide is the "coupling factor." Example: 20 db coupling means a ratio of power of 100:1. In practice, some reverse power in the main guide is coupled to the output of the auxiliary guide. The ratio of power of the auxiliary guide output from equal forward and reverse power in the main guide is the coupler's "directivity," and is usually expressed in db.

hp 752 Multi-Hole Coupler

In this coupler, the broad faces of two waveguides are joined together. Coupling is obtained from a series of graduated holes which are accurately machined along the broad faces of the waveguides. Power flowing down the primary guide couples through the holes, exciting waves which propagate in both directions in the auxiliary. By proper spacing of the holes, waves traveling in the reverse direction are out of phase and cancel each other. Waves traveling in a forward direction reinforce each other. The power coupled into the auxiliary arm by a wave traveling in the main guide in the opposite direction is absorbed by a resistive termination. The auxiliary guide of the *752* is terminated in a low reflection load at one end and in a precision cover flange at the other end. Detection of power in the auxiliary arm can be achieved readily by connecting a crystal detector or bolometer mount to the open end.

Model *752* has an overall directivity of better than 40 db (including reflection from built-in termination and flange) over its entire range. Coupling factors are 3, 10 and 20 db; accuracy of mean coupling level is ± 0.4 db (± 0.7 db for K- and R-band instruments) and frequency sensitivity of coupling is ± 0.5 db over the waveguide frequency range. These couplers are particularly suited for measurement of very small reflections, for rapidly adjusting transmission line flatness over the entire frequency range of the guide or

Specifications

Frequency Range:	215 to 450 mc	450 to 940 mc	940 to 1900 mc	1900 to 4000 mc
Minimum Directivity:	40 db	40 db	40 db	30 db
Coupling Attenuation:	20 db	20 db	20 db	20 db
Accuracy of Coupling:	(each secondary arm)	(each secondary arm)	(each secondary arm)	(each secondary arm)
Coupling variation:	Not more than ± 1 db over frequency ranges	Not more than ± 1 db over frequency ranges	Not more than ± 1 db over frequency ranges	Not more than ± 1 db over frequency ranges
Max Primary Line SWR:	1.15	1.15	1.15	1.25
Max Secondary Line SWR:	(50-ohm terminations)	(50-ohm terminations)	(50-ohm terminations)	(50-ohm terminations)
Power Handling Capacity:	50 watts cw	50 watts cw	50 watts cw	50 watts cw
Primary Line Insertion Loss:	Approx. 0.15 db	Approx. 0.20 db	Approx. 0.25 db	Approx. 0.35 db
Primary Line Connectors:	Precision Type N connectors, one male, one female	Precision Type N connectors, one male, one female	Precision Type N connectors, one male, one female	Precision Type N connectors, one male, one female
Secondary Line Connectors:	hp 11512A Shorting Jack (for reflectometer calibration)	hp 11512A Shorting Jack (for reflectometer calibration)	hp 11512A Shorting Jack (for reflectometer calibration)	hp 11512A Shorting Jack (for reflectometer calibration)
Size (in.):	9.04 x 3.1 x 1.78	9.04 x 3.1 x 1.78	6.34 x 2.80 x 1.77	6.34 x 2.80 x 1.77
Weight (lbs.):	Net 2 3/4	Net 2 3/4	Net 2 3/4	Net 2 3/4
Shipping 4	Shipping 4	Shipping 4	Shipping 4	Shipping 4
Price:	\$200	\$200	\$200	\$200

Measured with hp 906A Sliding Termination or K03-805C Line Length Set.
Other combinations of male, female connectors available on request.

Specifications of 750 Cross-Guide Couplers

Model	Coupling (db)	Frequency (gc)	Waveguide Size (in.)	Physical Size (in.)	Shipping Weight (lbs.)	Price
S750D	20	2.6 - 3.95	3 x 1 1/2	9 x 9	18	\$150
S750E	30	2.6 - 3.95	3 x 1 1/2	9 x 9	18	\$150
G750D	20	3.95 - 5.85	2 x 1	6 x 6	7	\$120
G750E	30	3.95 - 5.85	2 x 1	6 x 6	7	\$120
J750D	20	*5.85 - 8.2	1 1/2 x 3/4	5 x 5	4	\$100
J750E	30	*5.85 - 8.2	1 1/2 x 3/4	5 x 5	4	\$100
H750D	20	7.05 - 10	1 1/4 x 5/8	4 x 4	3	\$75
H750E	30	7.05 - 10	1 1/4 x 5/8	4 x 4	3	\$75
X750D	20	8.2 - 12.4	1 x 1/2	3 x 3	2	\$60
X750E	30	8.2 - 12.4	1 x 1/2	3 x 3	2	\$60

Directivity: Approximately 20 db or more.
Coupling Accuracy: Less than ± 1.7 db variation from nominal value over entire frequency range of guide.
*J750 couplers usable to 5.3 gc. Directivity same as above. Coupling within ± 3 db of nominal value.

Specifications of 752 Multi-Hole Couplers

Band (Prefix)	Frequency (gc)	Waveguide Size (in.)	Mean Coupling Accuracy (db)	SWR	752A Main Guide	752C,D Load (w)	A Power Avg. Guide	C Length (in.)	D	Shipping Weight (lbs.)	Price
S	2.6 - 3.95	3 x 1 1/2	± 0.4	1.1	1.05	2	50 - 1/4	48	48	40	\$400
G	3.95 - 5.85	2 x 1	± 0.4	1.1	1.05	2	34 - 5/8	33	33	19	\$300
J*	5.85 - 8.2	1 1/2 x 3/4	± 0.4	1.1	1.05	1	26 - 1/2	25 - 9/16	25 - 9/16	16	\$190
H	7.05 - 10	1 1/4 x 5/8	± 0.4	1.1	1.05	1	18 - 5/8	17 - 1/2	17 - 1/2	5	\$135
X	8.2 - 12.4	1 x 1/2	± 0.4	1.1	1.05	1	16 - 11/16	15 - 11/16	15 - 11/16	4	\$110
M	10 - 15	.850 x .475	± 0.4	1.1	1.05	1	16 - 5/16	15 - 11/16	15 - 11/16	4	\$175
P	12.4 - 18	.702 x .391	± 0.4	1.1	1.05	1	13 - 3/4	12 - 1/4	12 - 1/4	3	\$125
K†	18 - 26.5	.500 x .250	± 0.7	1.1	1.05	1/2	10 - 5/8	9 - 15/16	9 - 15/16	3	\$200
R†	26.5 - 40	.360 x .220	± 0.7	1.1	1.05	1/2	11 - 5/8	8 - 5/8	8 - 23/32	2	\$250

When ordering, specify suffix letter to indicate nominal coupling: A for 3 db, C for 10 db, D for 20 db. (Example: S-band, 3 db coupling, Model S752A.)
*Directivity is at least 40 db.
†Mean coupling is the average of the maximum and minimum coupling values in the rated frequency range.
*Coupling variation over rated frequency range is not more than ± 0.5 db about mean coupling.
*J752 Couplers operate to 5.3 gc with reduced performance.
†Circular flange adapters: K-band (UG-423/U), hp 11515A, \$35 each; R-band, (UG-381/U) hp 11516A, \$40 each.

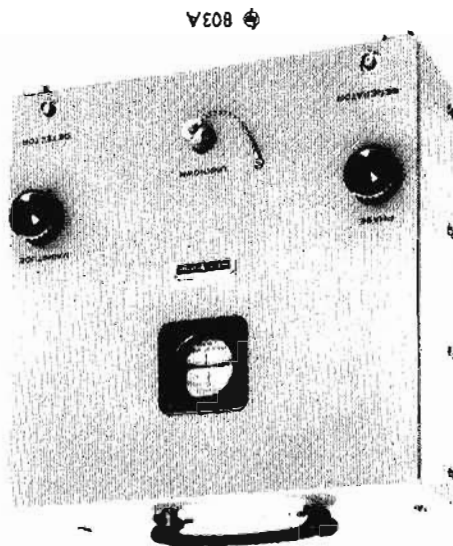
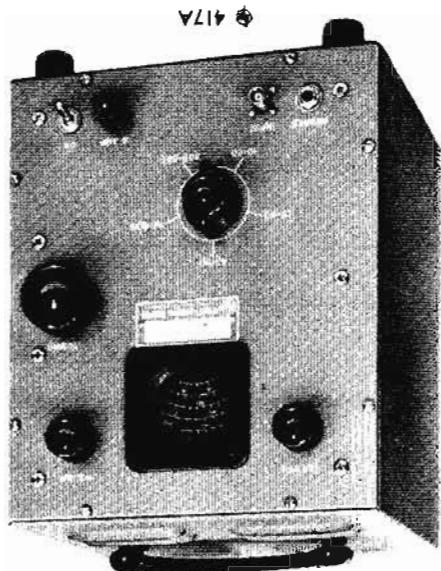

hp 803A VHF BRIDGE, hp 417A VHF DETECTOR

Model 803A VHF Bridge provides direct impedance measurements from 5 to 500 mc by sampling the electric and magnetic fields in a transmission line. Two attenuators are controlled simultaneously; one receives energy proportional to the electric field in the transmission line, and the other receives energy proportional to the magnetic field. The magnitude of the unknown impedance is determined by adjusting this combination for equal output from each attenuator. The two equal signals are also applied to opposite ends of another transmission line, and phase angle is found from their point of cancellation. This method permits fast, accurate impedance measurement without the cumbersome calculations required to convert slotted line swr to impedance.

Specifications

hp 803A

Measurement Range: Impedance magnitude, 2 to 2000 ohms. Higher and lower values may be measured by using a known length of transmission line as an impedance transformer. Phase angle from -90° to $+90^\circ$ at 55 mc and above.

Calibration: Impedance: Directly in ohms. Phase angle directly in degrees at 100 mc, may be readily computed at other frequencies. Phase Angle (actual) = Phase Angle (read) x Frequency (mc)/100.

Accuracy: (Over range 55 to 500 mc.) Impedance magnitude, better than $\pm \left(5 + \frac{\text{Frequency mc}}{500} \right) \%$

Phase angle better than $\pm \left(3 + \frac{\text{Frequency mc}}{500} \right)$ degrees.

Graphs are provided with each instrument so that magnitude readings may be corrected to better than $\pm 2\%$ and phase angle to better than $\pm 1.2^\circ$ over the rated frequency range.

Frequency Range: Maximum accuracy 55 to 500 mc. Useful down to 5 mc and up to 1000 mc. Maximum measurable phase angle at 5 mc is -8.8° to $+8.8^\circ$.

External RF Generator: Requires an amplitude modulated rf signal source with at least 1 mw output. For better resolution, a 10 mw, 100% amplitude modulated, rf signal source is recommended. (hp Model 608C VHF Signal Generator, pages 212, 213, is ideal for this purpose.)

RF Detector: Requires a well-shielded vhf receiver of better than 5 μ v sensitivity. (hp Model 417A VHF Detector is designed for this use.)

Dimensions: 14 1/4" wide, 15 1/4" high, 9" deep.

Weight: Net 28 lbs. Shipping 41 lbs.

Accessories Furnished: 1 803A-16D Cable Assembly; 1 803A-16E Cable Assembly; 1 hp 11512A Shorting Plug.

Price: \$1000.

hp 417A VHF Detector

This is a super-regenerative (AM) receiver covering all frequencies between 10 and 500 mc in 5 bands. Designed for use with the hp 803A VHF Bridge, the 417A provides a high sensitivity of approximately 5 microvolts over the entire frequency band. It has a single, convenient frequency control directly calibrated in megacycles.

Specifications

hp 417A

Frequency Range: 10 to 500 mc, continuous coverage, 5 bands. Calibrated directly in mc.

Sensitivity: Approximately 5 microvolts over entire frequency range.

Power: 115 or 230 v $\pm 10\%$, 50 to 60 cps, 35 watts.

Dimensions: 9 1/4" wide, 12 1/2" high, 9" deep.

Weight: Net 18 lbs. Shipping 28 lbs.

Accessories Available: hp 11001A Cable Assembly, \$5.50; hp 10503A Cable Assembly, \$6.50; 803A-16E Cable Assembly, \$9.

Price: \$475.

Data subject to change without notice.

Specifications

⊕ 805C

Frequency Range: 500 MC to 4,000 MC (minimum frequency determined by usable length of 14 1/2 inches).

Characteristic Impedance: 50 ohms. (For use with any 50 ohm cable using Type N connector.)

Connectors: Type N. (One male; one female.) Special fittings designed to mate with Type N connectors, provide a minimum SWR. Connectors compensated so that either end may be connected to the load.

Residual SWR: 1.04.

Calibration: Metric; calibrated in cm and mm. Vernier permits reading to 0.1 mm.

Detector Probe: Tunable probe provided for entire frequency range.

Detector element may be 1N21B crystal (supplied with instrument), or 821 series battery, or selected 1/100 amp. instrument fuse.

Weight: Net 18 lbs. Shipping 30 lbs.

Accessories Furnished: 11512A Shorting Plug; 11511A Shorting Jack.

Accessories Available: 11501A Cable Assembly, \$19.00; 11500A RF Cable Assembly, \$19.00; 475B-34V Battery Adapter, \$2.00;

10503A Cable Assembly, \$6.50; 11510A Carrying Case 29" long, 9 1/2" high, 9 1/2" wide, \$65.00.

Price: ⊕ 805C, \$525.00.

⊕ 805D

Price: ⊕ 805D, \$600.00.

Residual SWR: 1.02.

Connections: (One male, one female UG 45/U and UG 46/U.)

Characteristic Impedance: 46.3 ohms. For use with rigid coaxial lines, 7/8" outside diameter.

Same as 805C, except:

Two versions of the ⊕ 805 are offered; the 805C, provided with Type N connectors, and the 805D with connectors suitable for mating to 46.3-ohm coaxial cable, 7/8" outer diameter.

Data subject to change without notice.

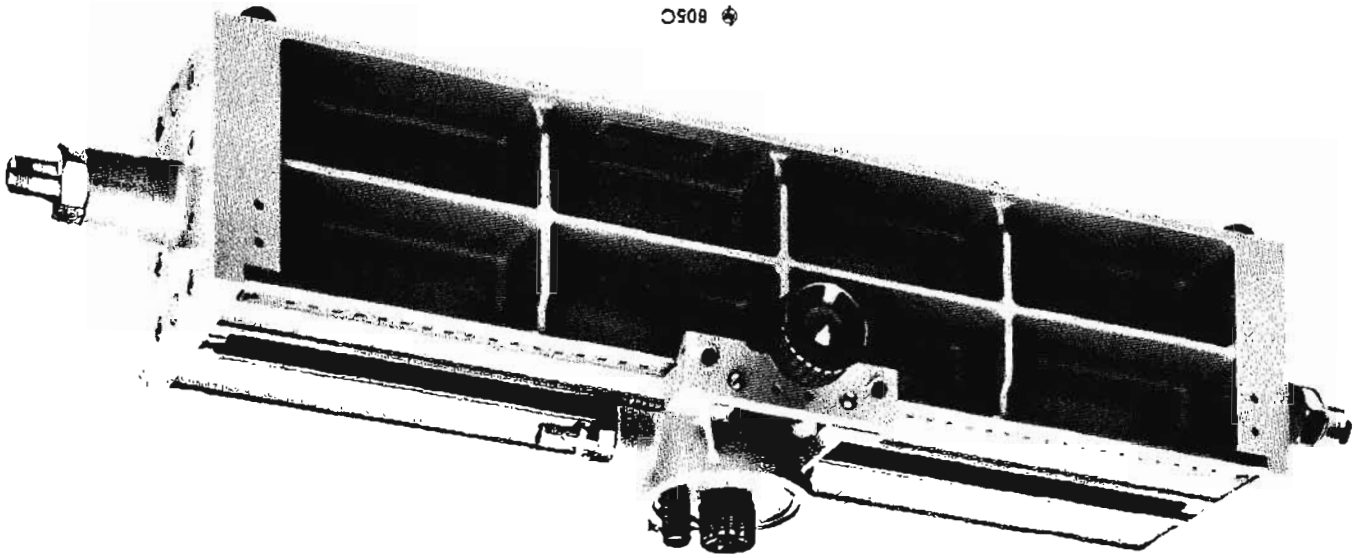

⊕ 805C

hp UNIVERSAL PROBE

CARRIAGES, SLOTTED LINES, PROBES, DETECTORS

Low Cost Precision Tools

for Microwave Measurements

to 18 GC

Advantages:

- Universal carriage mounts 7 different slotted sections, 3 to 18 gc
- Operates with *hp* waveguide or coaxial slotted sections
- Slotted sections easily interchanged
- Easy to use, accurate, compact
- Mounts dial gauge for high accuracy

Uses:

- Measure standing wave magnitude and phase
- Measure impedance
- Determine degree of antenna-match
- Determine percent of transmitted or reflected power

Model 809B Universal Probe Carriage is a precision mechanical assembly that operates with six *hp* 810B Waveguide Slotted Section (3.95 to 18 gc) and with *hp* 806B Coaxial Slotted Section (3 to 12 gc).

The universal probe carriage eliminates the cost of a probe carriage for each frequency band. Sections can be interchanged in 30 seconds or less. The 809B is designed for use with either the *hp* 444A Untuned Probe or with the *hp* 440A Detector and the *hp* 442B Broadband Probe in combination. The probe carriage has a centimeter scale with a vernier reading to 0.1 mm, and provision is also made for mounting a dial gauge where more accurate probe position readings are required.

Model 809B is simple in mechanical design and is carefully manufactured to assure trouble-free operation. The carriage moves on ground stainless steel rods, and its 3-point suspension system includes a two linear-motion ball bearings with dust seals and permanent lubrication. A conventional ball bearing forms the third point of suspension. Accuracy is equal or superior to that of the most expensive custom-made slotted lines.

hp 810B Waveguide Slotted Sections

The *hp* 810B Waveguide Slotted Section is an accurately machined section of waveguide in which a small longitudinal slot is cut. A traveling probe on the 809B Carriage samples the waveguide's electric field along the slot and permits precise plotting of variations along the entire length of probe

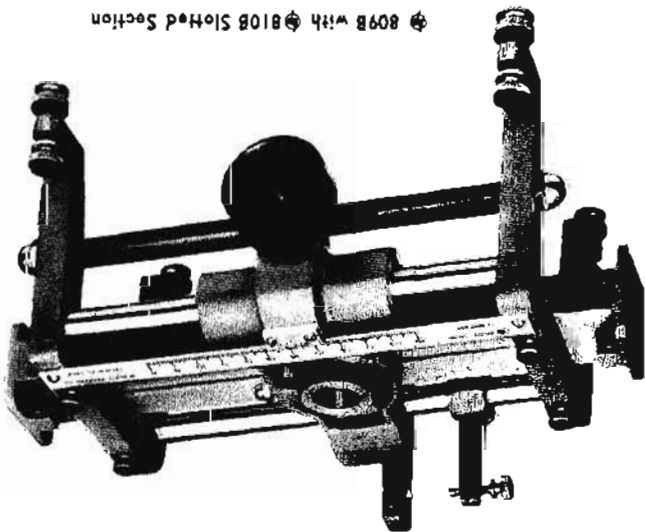

hp 809B with hp 810B Slotted Section

travel. Ends of the slots are tapered to reduce SWR to less than 1.01. A high order of accuracy and stability is maintained. The sections are available in six waveguide sizes.

hp 806B Coaxial Slotted Section

Designed for use with the 809B Carriage, this instrument provides continuous coverage from 3 to 12 gc. Impedance is 50 ohms to match flexible coaxial cables. The broadband section has special fittings mating with Type N connectors to assure a minimum SWR.

hp 810A Waveguide Slotted Section

This instrument is a conventional type of slotted waveguide complete with probe carriage mounted directly on the section. It is available only in the 3 x 1 1/2 inch size. (S-band, 2.6 to 3.95 gc). The carriage accepts *hp* 442B Broadband Probe or *hp* 444A Untuned Probe.

hp 440A Detector Mount

The *hp* 440A is a tunable, easy-to-use instrument for detecting rf energy in coaxial systems (2.4 to 12.4 gc) or in conjunction with the *hp* 442B, in waveguide or coaxial slotted sections. It is particularly useful when error-producing harmonics are present. Just one adjustment is required for tuning. Crystals or bolometers may be used interchangeably in the same holder. A built-in rf bypass is provided.

hp 442B Broadband Probe

This is a probe whose depth of penetration into a slotted section is variable. Held in position by friction, it may be fixed in place by a locking ring. Sampled rf appears at a Type N jack, permitting direct connection to a receiver, spectrum analyzer or other instrument. It may be connected to a Model 440A Detector Mount to form a sensitive and convenient tuned rf detector for slotted waveguide sections. Model 442B fits the 809B Carriage. Price, \$50.

hp 444A Untuned Probe

This probe consists of a crystal, plus a small antenna in a convenient housing. The probe is held in position by friction.



⊕ G810B



⊕ 806B

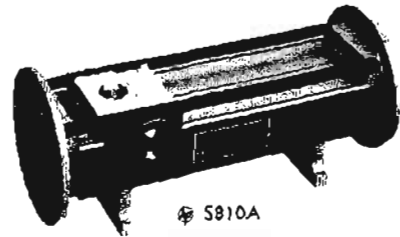

⊕ S810A



⊕ 440A



⊕ 444A



⊕ 442B

tion or may be fixed by a locking ring. No tuning is required, and sensitivity equals or excels many elaborate single- and double-tuned probes, particularly over the 8 to 18 gc range. As with the *hp* 442B, polyiron inserts damp out spurious resonances, and the 444A fits the *hp* 809B Carriage or other carriages with a $\frac{3}{4}$ " mounting hole. This probe should not be used where harmonics are liable to cause errors.

Specifications

⊕ 809B Universal Probe Carriage

Carriage: Mounts all *hp* 810B Waveguide Slotted Sections and *hp* 806B Coaxial Slotted Section.

Probe Required: *hp* 442B Broadband Probe in combination with *hp* 440A Detector or *hp* 444A Untuned Probe.

Probe Travel: 10 cm.

Calibration: Metric; vernier permits readings to 0.1 mm; provision for dial gauge.

Dimensions: 8" long, $6\frac{1}{4}$ " wide, 5" high.

Price: \$175.

⊕ 810B Waveguide Slotted Sections

(For ⊕ 809B Carriage)

Model	Frequency Range (gc)	Fits Waveguide Size (in.)	Equiv. Flange	Price
G810B	3.95-5.85	2 x 1	UG-149A/U	\$125
J810B	5.3-8.2	$1\frac{1}{2}$ x $\frac{3}{4}$	UG-344/U	\$110
H810B	7.05-10.0	$1\frac{1}{4}$ x $\frac{5}{8}$	UG-51/U	\$110
X810B	8.2-12.4	1 x $\frac{1}{2}$	UG-39/U	\$ 90
M810B	10.0-15.0	.850 x .475	—	\$175
P810B	12.4-18.0	.702 x .391	UG-419/U	\$110

Length of all sections: $10\frac{1}{4}$ ".

Slope and irregularities: Slot discontinuity results in swr of less than 1.01.

⊕ 806B Coaxial Slotted Section

(For ⊕ 809B Carriage)

Carriage: Fits *hp* 809B Universal Carriage Probe.

Frequency Range: 3 to 12 gc.

Impedance: 50 ohms.

Connections: Type N, one male, one female. Special fittings provide minimum swr. Either end may be connected to load. Includes shorting connectors, male and female, for phase measurements.

Residual SWR: Less than 1.04, 3 to 8 gc. Approx. 1.06, 8 to 10 gc. Approx. 1.1, 10 to 12 gc.

Pick-up Error: Probe pick-up variation along line is less than 0.1 db except at extreme ends, where it is less than 0.4 db.

Length: 10".

Price: \$200.

⊕ S810A Waveguide Slotted Section

Conventional waveguide slotted section with probe carriage mounted directly on waveguide. Will accept *hp* 442B or 444A Probes.

Frequency Range: 2.6 to 3.95 gc.

Residual SWR: Less than 1.01.

Waveguide Size: 3 x $1\frac{1}{2}$ ".

Length: $12\frac{3}{4}$ ".

Price: \$450.

⊕ 440A Detector Mount

Frequency Range: 2.6 to 12.4 gc.

Detector (not supplied): 1N21 or 1N23 silicon crystals or 821 series barretter.

Tuning: Single stub.

Connectors: UG-21B/U (rf input); BNC female (detector output).

Price: \$85.

⊕ 444A Untuned Probe

Frequency Range: 2.6 to 18 gc.

Output Connector: BNC female.

Detector: Supplied.

Price: \$55.

Data subject to change without notice.

hp 814B CARRIAGE, 815B SECTIONS, 446B PROBE

Easy-to-Use Instruments for Measurements to 40 GC

Advantages:

- Mounts K- and R-Band slotted sections
- Sections interchange quickly
- Dial indicator for high accuracy
- Simple operation, compact, low cost

Uses:

- Measure swr
- Measure impedance
- Determine system flatness, connector reflection

The hp 814B Universal Probe Carriage is a precision mechanical assembly designed for use with the hp K and R 815B Waveguide Slotted Sections and hp 446B Untuned Probe. The carriage is equipped with a dial indicator for accurate readings. Slotted sections are easily interchanged.

The K and R 815B Waveguide Slotted Sections are designed and finished to fit the 814B in a precisely indexed position. Each consists of an accurately machined waveguide section with a narrow longitudinal slot, tapered to insure a low swr. A traveling probe mounted on the 814B Carriage samples the waveguide's electric fields along the slot.

The hp 446B is a broadband detector and probe which consists of a modified 1N53 silicon diode in a carefully designed shielded housing. No tuning is required, and probe penetration may be quickly and easily varied.

Specifications

814B Universal Probe Carriage

Carriage: Mounts hp 815B Waveguide Slotted Sections.
Probe Required: hp 446B Untuned Probe.
Calibration: Metric. Dial gauge with 0.01 mm division.
Size: 6¼" long, 6¼" wide, 6½" high.
Price: \$225.

815B Waveguide Slotted Section

	K815B	R815B
Frequency Range (gc):	18.0 - 26.5	26.5 - 40.0
Residual SWR:	1.01	1.01
Flange*	UG595/U	UG599/U
Fits Waveguide (in.):	.500 x .250	.360 x .220
Overall Length (in.):	7-9/16	7-9/16
Price:	\$265	\$245

*Circular Flange Adapters: K-Band {UG-425/U} hp 11515A, \$35 each.
R-Band {UG-381/U} hp 11516A, \$40 each.

446B Untuned Probe

Carriage: Mounts in hp 814B.
Frequency Range: 18 to 40.0 gc.
Detector: Modified 1N53 silicon diode, installed.
Price: \$145.

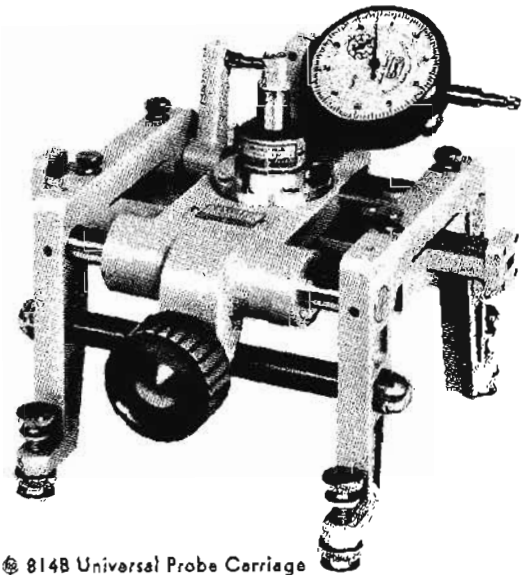

814B Universal Probe Carriage

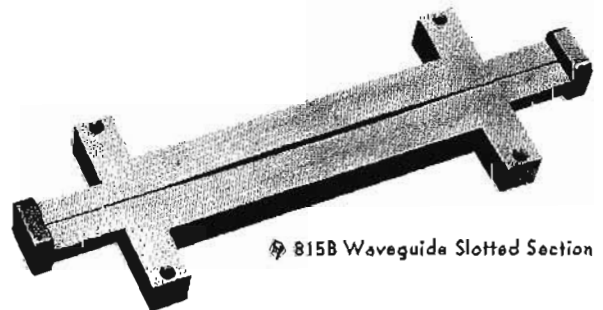

815B Waveguide Slotted Section



446B Untuned Probe

hp 870, 872 SLIDE-SCREW TUNERS, 880 E-H TUNER

870A Slide-Screw Tuners 2.6 to 40 GC

Slide-screw tuners are used to match loads, terminations, bolometers and thermistor mounts, or antennas to the characteristic impedance of the transmission system. The hp 870A tuner consists of a waveguide slotted section with a precision carriage that supports an adjustable probe. The position and penetration of the probe is adjusted to set up a reflection which is used to cancel an existing reflection in the system. An swr of 20 can be corrected to 1.02 and small swr's may be exactly corrected.

Probe penetration is varied with a threaded adjustment on the S-band model of this instrument. A micrometer drive is used on the other models. K- and R-bands also have a micrometer drive to move the probe along the guide (readable to 0.01 mm); on other models the probe is positioned with a thumb-operated wheel (readable to 0.1 mm).

Frequency coverage, shipping weight and price are given here. Additional specifications for each model appear on pages 168 to 178 in the microwave section of this catalog.

Specifications

Model	Frequency Range (gc)	Shipping Weight (lbs.)	Price
S870A	2.6 - 3.95	15	\$250
G870A	3.95 - 5.85	7	\$200
J870A	5.3 - 8.2	7	\$165
H870A	7.05 - 10.0	4	\$140
X870A	8.2 - 12.4	3	\$130
M870A	10.0 - 15.0	3	\$170
P870A	12.4 - 18.0	3	\$140
K870A*	18.0 - 26.5	3	\$250
R870A*	26.5 - 40.0	3	\$300

*Circular flange adapters: K-Band (UG-425/U) hp 11515A, \$35 each.
R-Band (UG-381/U) hp 11516A, \$40 each.

872A Coaxial Slide-Screw Tuner 0.5 to 4 GC

This coaxial slide-screw tuner consists of a parallel plane line and a precision probe carriage and exhibits exceedingly low insertion loss. A micrometer drive quickly and easily varies probe insertion into the line, and position along the line may be read on a recessed scale. Carriage travel is at least $\frac{1}{2}$ wavelength at 500 mc, so that any phase of reflection may be cancelled. Magnitude and phase are independently adjustable, making the 872A much more convenient than double-stub tuners. Both penetration and position of the probe may be logged so that settings may be repeated easily. The probe may be completely withdrawn so that no correction is applied.

Specifications

Frequency Range: 500 to 4000 mc.
Correctable SWR: 5.
Insertion Loss at Maximum Correctable SWR: 0.5 db or less.
Characteristic Impedance: 50 ohms.
Connectors: Type N, one male, one female.
Dimensions: Approx. 27" long, 9" high, 5" wide.
Weight: Net 10 lbs. Shipping 30 lbs.
Accessories Available: hp 11511A Shorting Jack, \$4. hp 11512A Shorting Plug, \$4.50. hp 11510A Carrying Case, 29" long, 9 $\frac{1}{2}$ " high, 9 $\frac{1}{2}$ " wide, \$65.
Price: \$525.

880 E-H Tuners, 8.2 to 18 GC

The hp 880A,B tuners consist of a straight section of waveguide to which series and shunt tuning arms are attached. Each arm has a movable short circuit which may be positioned by a fine tuning control. Tuners of the E-H configuration are particularly useful where rf leakage is undesirable. Standing wave ratios as high as 20 may be reduced to less than 1.02. See pages 172 to 175 for additional specifications. Model X880A, 8.2-12.4 gc; shipping weight, 3 lbs.; price, \$130. Model P880B, 12.4-18 gc; shipping weight, 3 lbs., price, \$150.

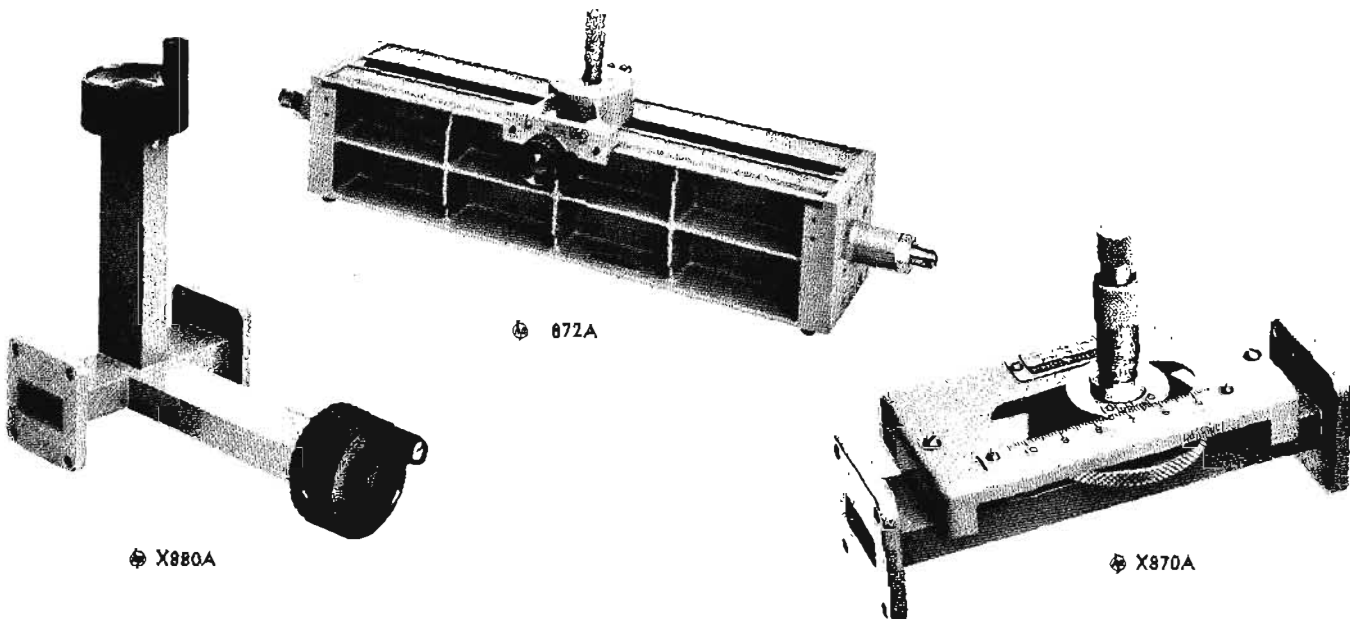

885A WAVEGUIDE PHASE SHIFTERS

Precision Phase Variation for J-, X- and P-Band Systems

Hewlett-Packard 885A Phase Shifters provide accurate, controllable phase variation in the J-, X- and P-Band frequency ranges. They are particularly useful in microwave bridge circuits, where phase and amplitude must be adjusted independently. They are also used in the study of phased arrays.

The instrument has a high accuracy over its entire phase range of -360 to $+360$ electrical degrees, has low power absorption, is simple to operate, and requires no charts or interpolation. It is sturdily built, comprising two rectangular-to-circular waveguide transitions with a dial driven circular waveguide mid-section. The instrument is housed in a cast aluminum container for rigidity and durability.

Specifications

Model	Frequency GC	Accuracy	Insertion Loss	Loss Variation with Phase Setting	Max. Average Input Power	Length	Price
J885A	5.3 - 8.2	3°	2 db max.	0.4 db max.	10 watts	26"	\$550
X885A	8.2 - 12.4	2° 8.2 - 10 gc 3° 10 - 12.4 gc	1 db max. 8.2 - 10 gc 2 db max. 10 - 12.4 gc	0.3 db max. 8.2 - 10 gc 0.4 db max. 10 - 12.4 gc	10 watts	15 $\frac{5}{8}$ "	\$425
P885A	12.4 - 18.0	4°	3 db max.	0.5 db max.	5 watts	12 $\frac{1}{2}$ "	\$600

All models: swr (maximum), 1:35. For small phase differences accuracy is as tabulated or 10%, whichever is less.

Data subject to change without notice.

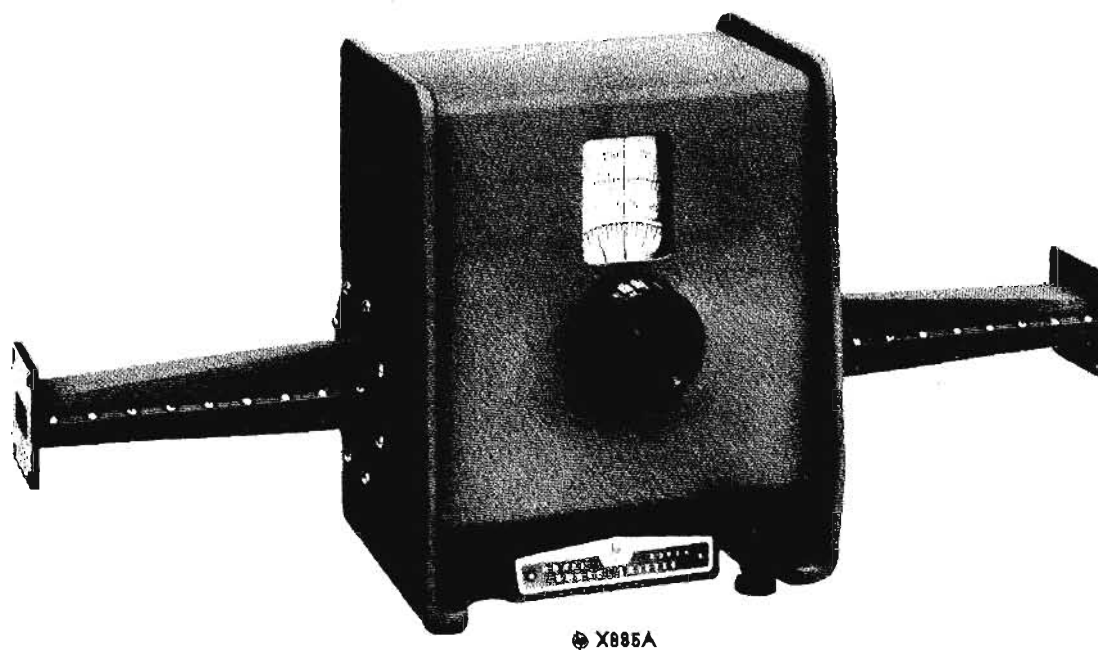

 X885A

**hp WAVEGUIDE, COAXIAL TERMINATIONS, LOADS,
WAVEGUIDE SHORTS**

hp 910, 908, 912, 913 Terminations

The hp 910 Series is designed for terminating waveguide systems operating at low average powers with a peak power of 1 kw. They feature low swr and cover frequencies from 2.6 to 18.0 gc in six models, ranging in price from \$35 to \$75.

The Model 908A is a low reflection load for terminating 50-ohm coaxial systems in their characteristic impedance. Frequency range is dc to 4 gc, with the swr of the coaxial termination less than 1.05 over the entire range. Price, \$35.

The hp S912A and the hp X913A are high power terminations which do not require cumbersome water connections. The S912A, \$200, is designed for waveguide systems operating at 100 watts average and 100 kw peak power. The X913A, \$100, will dissipate 500 watts average, 100 kw peak power.

hp 914, 906 Loads, 916 Standard Reflections

Model 914 Moving Load consists of a section of waveguide in which is mounted a sliding, tapered low-reflection load. A plunger controls the position of the load, moving it at least 1/2 wavelength at the lowest waveguide frequency. Thus the phase of the residual load reflection may be reversed so that this reflection can be separated from the other small reflections in the system. Nine models cover from 2.6 to 40.0 gc and range in price from \$60 to \$290.

The 906A Sliding Coaxial Load is a movable, low reflection termination for 50-ohm systems. It covers 1 to 12.4

gc and moves at least 1/2 wavelength at its lowest rated frequency. Price, \$250.

Model X916 Standard Reflections, available in 4 models, are precision loads used to set up exact reflections for standardizing swr measuring setups. Nominal reflection coefficients for the four models (B through E) are 0.05, 0.10, 0.15 and 0.20. Each is priced at \$125.

hp 920, X930 Waveguide Shorts

Model 920A,B Waveguide Shorts, available in 9 bands covering 2.6 to 40.0 gc, are convenient instruments for introducing a variable element in waveguide systems. They can be used to provide a variable short-circuit reference point. Price, \$75 to \$195.

Model X930A Waveguide Shorting Switch, 8.2 to 12.4 gc, provides a removable short in a waveguide circuit. Price, \$160.

Additional specifications of the hp instruments described on this page appear on the respective frequency band pages in the microwave section of this catalog (pages 164 through 181).

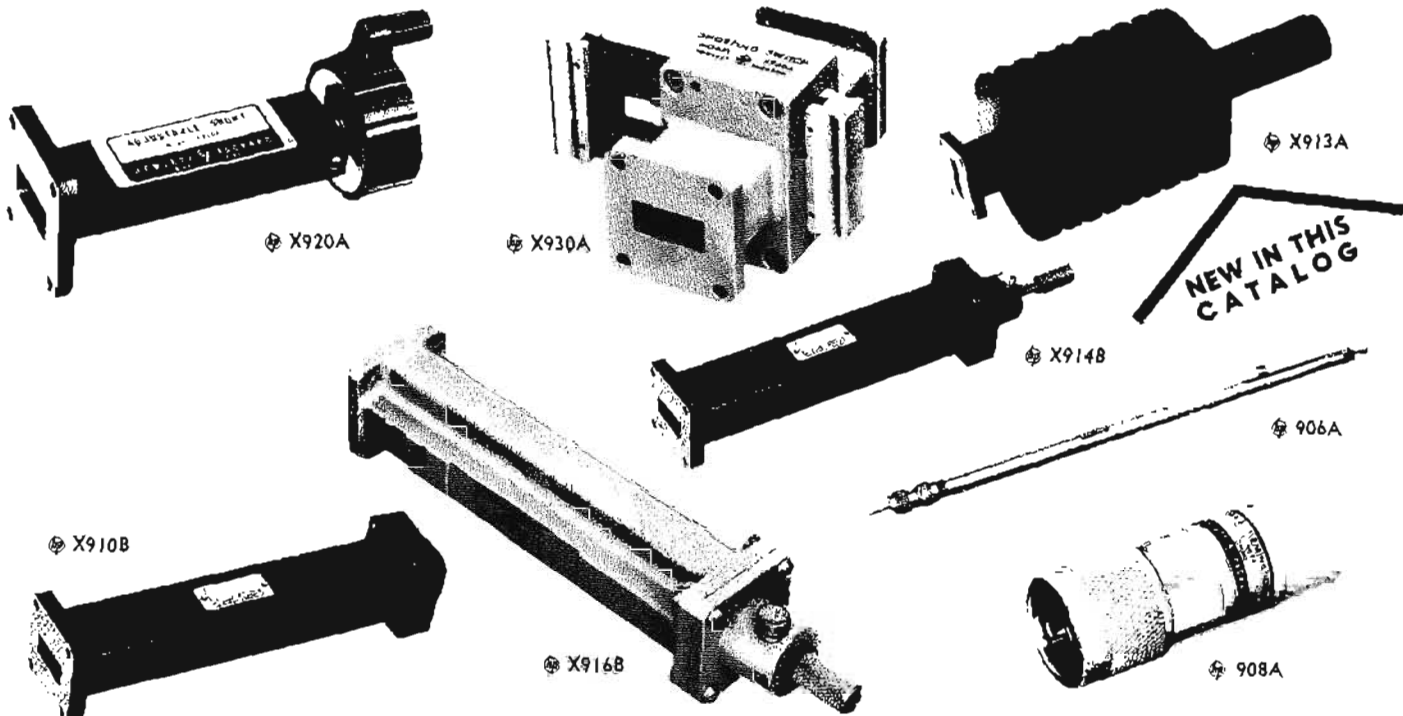

hp 4011A, 4012A STATIC INVERTERS

hp 4301A VARIABLE FREQUENCY POWER SUPPLY

NEW IN THIS
CATALOG

Hewlett-Packard's line of ac power supplies includes static inverters (dc to fixed amplitude, single frequency sine or square wave) and a Variable Frequency Power Supply (ac line power to variable amplitude, variable frequency sine wave). Developed by the Paeco Division of Hewlett-Packard, these instruments are characterized by well designed circuitry and conservatively rated components to assure maximum reliability.

hp 4301A

The hp 4301A Variable Frequency Power Supply is a tunable RC oscillator feeding a low distortion power amplifier. With an input of 115 or 230 volts, 50 to 60 cps, Model 4301A produces a sine wave output which is adjustable from 0 to 260 v rms at any frequency from 40 to 2000 cps.

A three range voltmeter, incorporated on the front panel, monitors the output voltage. This same meter can be switched to read the biasing of the two push-pull output tubes and screwdriver adjustments on the front panel allow the operator to balance the output tubes for minimum distortion. Another adjustment is provided to set the output impedance to zero so that for any given load, the regulation will be 0% no load to full load. This is particularly useful for production testing of equipment. Once the regulation is set for the full load condition, the output voltage remains constant for the loaded and unloaded testing of the equipment.

hp 4011A Static Inverter is an ideal power supply for lab or field use or for powering military equipment. From an input of 25 to 32 v dc, Model 4011A produces an output sine wave adjustable from 380 to 420 cps which may be synchronized to an external signal. Output voltage is 115 v rms (180 va), is monitored by a meter and is adjustable $\pm 5\%$. Harmonic distortion is less than 5%, and regulation is better than $\pm 2\%$ from 1/10 to full load. Load power factors from 0.8 lead to 0.8 lag can be handled with no degradation of the above specifications. \$960.

hp 4012A Static Inverter converts a 125 v dc input ($\pm 10\%$) into a 60 cps quasi-square wave (see figure 1) at 115 v rms (400 va). The output voltage is adjustable $\pm 5\%$. The quasi-square wave provides maximum efficiency in the inverter while keeping the third harmonic content low. Regulation is $\pm 4\%$, and the instrument may be synchronized to an external signal. An output voltmeter is provided. \$1200.

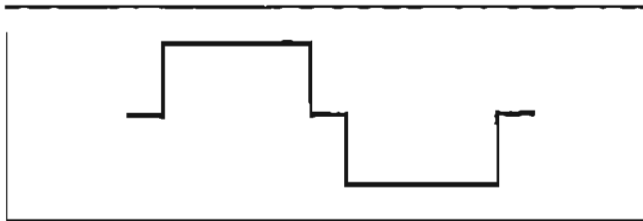
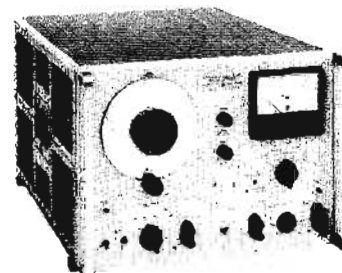

Figure 1. Quasi-square wave.

Data subject to change without notice.



hp 4301A

Specifications

- Output Power: 250 va.
- Output Voltage: 0 to 150 v (2 amps max.).
0 to 260 v (1 amp max.).
- Output Frequency: 40 to 2000 cps.
- Frequency Accuracy and Stability*: $\pm 1\%$.
- Load Regulation (resistive): Less than $\pm 1\%$ or ± 1 v (whichever is greater) with front panel regulation control fully clockwise. Can be set to give 0% for a given load condition.
- Line Regulation: Less than $\pm 1\%$ for $\pm 5\%$ line voltage changes at 250 va or less output power; less than $\pm 1\%$ for $\pm 10\%$ line voltage changes at 190 va or less output power.
- Harmonic Distortion: Less than 1.5% for resistive load; less than 5% for 0.7 power factor load.
- Hum and Noise: At least 65 db below rated output.
- Input Power: 115 or 230 v $\pm 10\%$, 50 to 60 cps, 500 to 750 watts.
- Dimensions: 12-17/32" high, 16 3/4" wide, 24 3/8" deep.
Hardware included for conversion to 12 1/4" x 19" rack mount.
- Weight: Net 124 lbs. Shipping 150 lbs.
- Price: \$1350.

*For increased accuracy and stability, an external driving signal may be used; frequency range is 40 to 2000 cps.

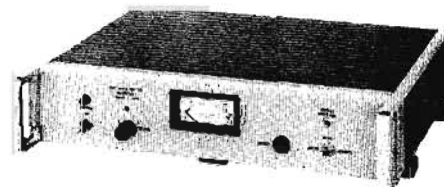

hp 4011A

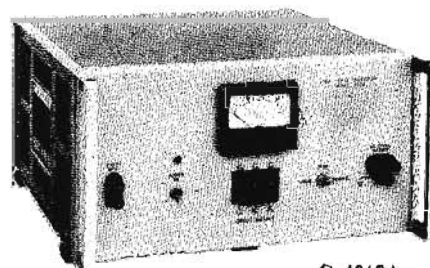

hp 4012A

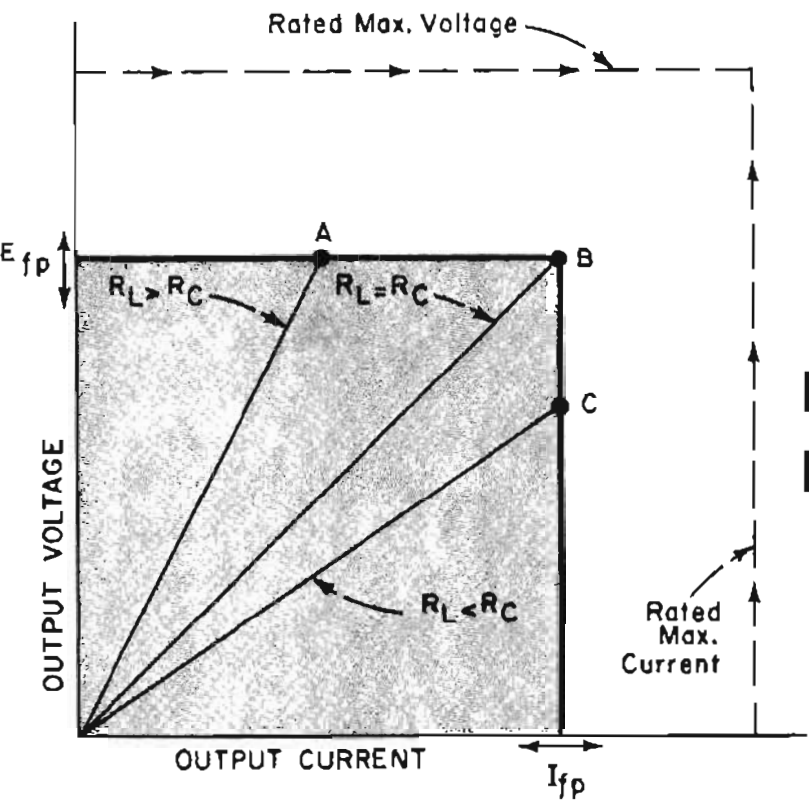

REGULATED POWER SUPPLIES

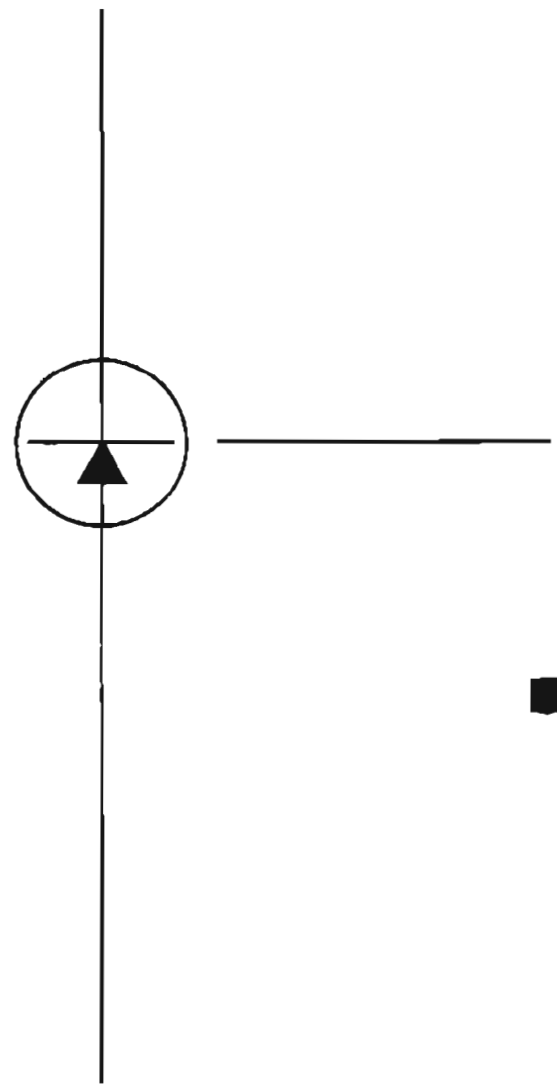

- Laboratory Power Supplies*
- Constant Voltage/Constant Current Supplies*
- Programmable Power Supplies*
- Plug-in Modular Supplies*
- High Current Supplies*
- High Voltage Supplies*



HARRISON LABORATORIES • 45 Industrial Road, Berkeley Heights, N.J.
(A Division of Hewlett-Packard)

Telephone 201-464-1234

DC REGULATED POWER SUPPLIES

The basic elements of a voltage-regulated dc power supply are shown in Figure 1. The rectifier and filter convert the ac line power into raw, unregulated dc power. The regulator normally is a tube or transistor, which functions as a variable impedance connected in series with the output line. It introduces the right amount of voltage drop in the line to hold the output at a preset, constant level despite changes in the raw dc.

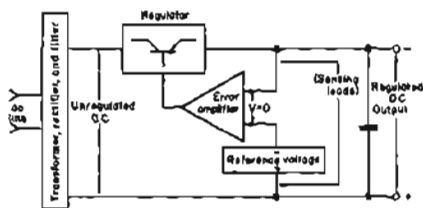

Figure 1. Regulated dc power-supply.

Regulator control originates in the error amplifier which compares the output voltage to the reference voltage and controls the regulator action to maintain this voltage difference constant.

The total system may be analyzed as a feedback control system which matches the output voltage to the reference voltage—an all-electronic closed-loop servo system, or as a dc power amplifier for which the reference voltage serves as the input signal.

Constant current regulation is achieved by a similar technique. The output current amplitude is converted to a voltage by a low-resistance current monitoring resistor in series with the output bus. Regulator action maintains this voltage, and thus the output current, at a constant level.

Basic Specifications

The prospective purchaser will find numerous specifications describing the performance of the power supply in which he is interested. Of primary importance, of course, are the available voltage and current output. Obviously, these should span the range of dc power required by the expected applications.

Regulation is specified either as the percentage change in output, resulting from changes in output load demand and/or input line voltage, or as a fixed allowable error. Good regulation is important if the circuits powered by the supply are sensitive to voltage fluctuations. The prospective purchaser would do well to ask for the highest degree of regulation necessary for the intended

application but should bear in mind that high regulation generally requires more complex circuitry with resulting higher cost.

The stability specification refers to the power supply's ability to maintain the selected output voltage (or current) at a constant value for long periods of time in a constant temperature environment. The effect of ambient temperature changes on the output is separately specified in terms of a temperature coefficient.

Output impedance is related to regulation. Low output impedance means, of course, that output voltage is affected only slightly by a change in current demand. Not often appreciated is the fact that output impedance, and consequently output voltage, is affected by the rate of change of the load current demand. The ac impedance of a power supply assumes importance when there is some ac superimposed on the dc drawn by the load.

Figure 2 graphically illustrates how the output impedance of a high quality constant voltage power supply varies as

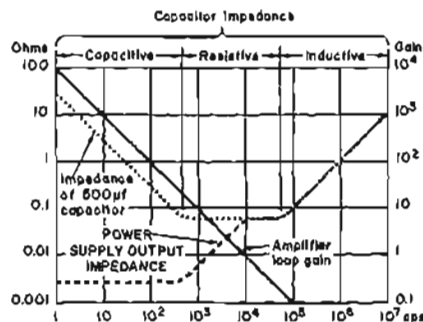

Figure 2. Output impedance vs. frequency of regulated constant voltage power supply with 500 μ f output capacitor. Feedback amplifier reduces impedance at low frequencies but has less effect as gain falls off. Capacitor impedance falls as frequency rises until capacitor resistance limits further reduction. Above approximately 100 kc, the capacitor's inductance determines output impedance.

a function of frequency. The ac impedance may provide a significant coupling medium between circuits; the prospective purchaser should evaluate the possible effect on his circuits of load-induced transients or ac signals superimposed on the power supply output dc.

A constant current supply requires a high output impedance ($\Delta E/\Delta I \gg 0$). The output capacitor so desirable for low output impedance in a constant voltage supply is a deterrent to achieving high output impedance. Some capacitance, though, does help to reduce ripple and improve stability in the presence of inductive loads.

Operating Refinements

The internal time constants of a power supply should be designed so that the regulator always has control of the output and will not allow transient overvoltages to appear at the output terminals during turn-on or turn-off of the ac power. Incidentally, sufficient protection is not provided by switch contacts which simply short the output when the power switch is turned off, since this provides no protection in the event of power failures or supply line switchoff.

A specification of transient recovery time ought to include the level to which the output recovers. A specification based on an assumed recovery time constant is insufficient, since a well-designed power supply has a recovery characteristic that is faster than an exponential curve.

Some form of protection for both the supply and external circuits in the event of excessive output current is included in most power supplies. Unfortunately, most semiconductor circuits, when overloaded, cannot survive the time lag required by a fuse or circuit breaker so that protection by power supply output current limiting is preferred. This usually is made controllable so that the user may select an upper current limit compatible with the external circuitry.

Protection against the effects of high resistance loads is required in constant current supplies, since such loads might cause excessive output voltage because of the low current drain.

Constant voltage/constant current power supplies feature both current and voltage limiting which makes it impossible for any overload condition to damage the power supply. In addition, this output characteristic lends itself to applications which cannot be met easily with normal supplies, e.g., automatic unattended battery charging (with no possibility of "gassing" or overcharging) and capacitor forming.

The efficiency of a power supply indicates the amount of excess heat dissipated. Since the regulator circuits pass the full output current while dropping the voltage, power dissipation is unavoidable though sophisticated design can reduce dissipation.¹

¹ For a description of these and other power supply circuits, please refer to "The Present Attainments of Adjustable Power Supplies," *hp Journal* Vol. 13, No. 11, July 1962.



**H LAB 855B, 865B, 6224A,
6226A REGULATED DC
POWER SUPPLIES**

Ideal Supplies for Work with Solid State Circuitry

Advantages:

Constant voltage, constant current operation with automatic crossover
Auto-Series, Auto-Parallel operation
Continuous one-knob output control, no range switching
No overshoot on turn-on, turn-off
Short-circuit proof in constant voltage use
Open-circuit proof in constant current use
Remote programming, remote sensing

Uses:

Powering transistor circuitry
Higher voltage/current use by "stacking"
Lab research and development
Systems applications

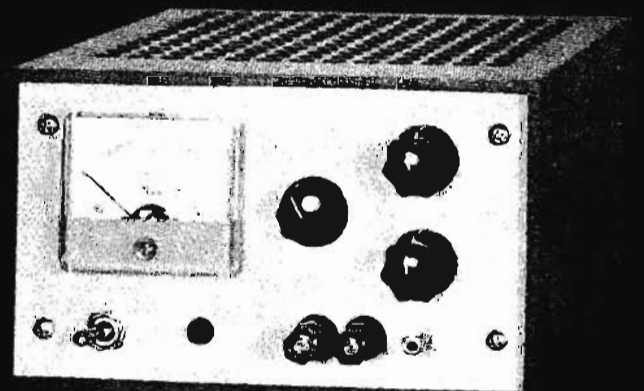

Because output current and voltage cannot exceed values equal to the setting of the front panel controls, the supplies are inherently protected from overload conditions, including continuous short circuit in constant voltage operation and continuous open circuit in constant current operation.

The supplies may be combined in series up to 500 volts from ground and in parallel with no limit to the number of units. Thus, it is simple to obtain voltages higher than those available from one supply alone, or to obtain a "chain" of regulated voltages all referenced to ground and all proportionally controlled with one knob. Interconnections are

made entirely on rear panel terminal strips. Features obtained when "stacking" the supplies include one-knob master control, automatic current and voltage equalizing and full range control from any selected module.

Models 855B and 865B may be rack mounted in Harrison Laboratories' R855/865-1B (one unit) or R855/865-2B (two units) Rack Mounting panels, \$20 each. Models 6224A and 6226A may be rack mounted in Hewlett-Packard rack adapters (see page 19).

Data subject to change without notice.

Specifications

		855B	865B	6224A	6226A		
Max. Ambient Operating Temperature:	50°C.						
Internal Impedance:	Less than 0.01 ohms, dc to 100 cps; 0.02 ohms, 100 cps to 1 kc; 0.5 ohms, 1 to 100 kc; 3 ohms, 100 kc to 1 mc.						
Overload Protection:	Completely protected in both modes of operation.						
Controls:	Coarse and fine controls for continuous adjustment of output over entire range.						
Meter:	Single meter with mode switch monitors both voltage and current output, 2% accuracy.						
Output Terminals:	Front and rear panel terminals isolated from supply chassis.						
		Output (dc)	0-18 volts 0-1.5 amps	0-40 volts 0-0.5 amps	0-18 volts 0-3 amps	0-36 volts 0-1.5 amps	
		Load Regulation:*	Constant Voltage (whichever is greater)	0.03% or 5 mv	0.01% or 4 mv	0.03% or 2 mv	0.02% or 2 mv
			Constant Current (whichever is greater)	0.03% or 250 μ a	0.05% or 250 μ a	0.05% or 600 μ a	0.05% or 300 μ a
		Line Regulation:**	Constant Voltage (whichever is greater)	0.03% or 5 mv	0.01% or 4 mv	0.02% or 2 mv	0.02% or 2 mv
			Constant Current (whichever is greater)	0.03% or 250 μ a	0.05% or 250 μ a	0.03% or 250 μ a	0.03% or 250 μ a
		Ripple and Noise:	Constant Voltage	200 μ v rms	200 μ v rms	500 μ v rms	500 μ v rms
			Constant Current	200 μ a rms	200 μ a rms	200 μ a rms	200 μ a rms
		Stability:	Less than 30 mv for 8 hours at a constant ambient temp. (after 30-minute warmup)†		Less than 0.05% or 5 mv for 8 hours at a constant ambient temp. (after a 30-minute warmup)†		
		Remote Programming:	Rear terminal strip, at approx. 500 ohms/volt		Rear terminal strip, at approx. 200 ohms/volt constant voltage, 300 ohms/amp constant current		
		Remote Sensing:	Provision made for remote error sensing on rear barrier strip				
		Power:	105 to 125 or 210 to 250 v, 50-440 cps, single phase		105 to 125 or 210 to 250 v, 50-70 cps, single phase		
		Size (width, height, depth):	7 13/16" x 5 1/16" x 8 1/2"		5 1/8" x 6 3/4" x 11"		
		Weight:	Net 12 lbs. Shipping 16 lbs.		Net 16 lbs. Shipping 20 lbs.		
		Price:	\$169***		\$275		

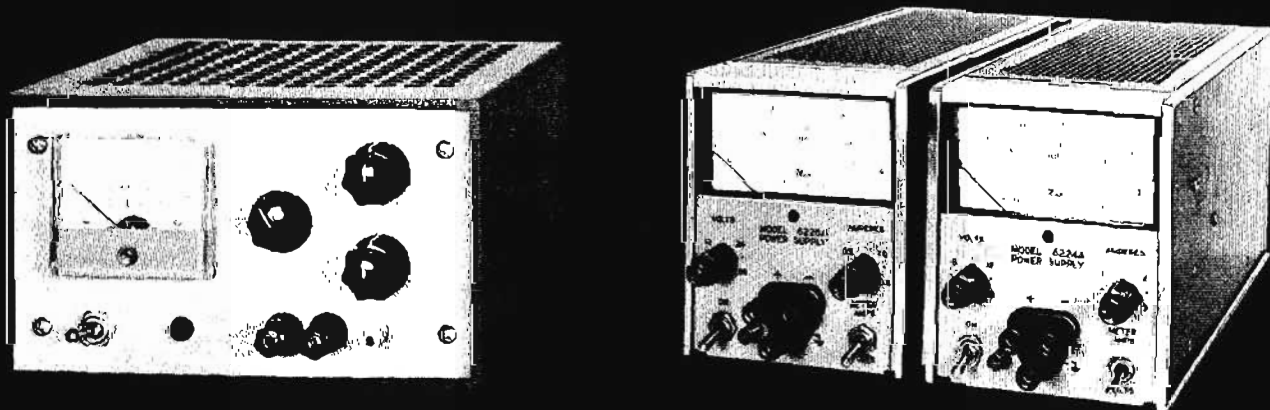

*Constant Voltage Load Regulation specification is given for a load current change equal to the current rating of the supply.

Constant Current Load Regulation specification is given for a load voltage change equal to the voltage rating of the supply.

**For a change in line voltage from 105 to 125 (or 125 to 105) at any output voltage and current within rating.

***Add \$12 for slipover case as pictured above. Standard unit at \$169 has top and bottom cover plates and is a completely enclosed power supply.

†Using precision wire-wound remote programming resistor or rheostat.

H Lab 6204A, 6206A Dual Range Power Supplies

Competitively priced with instruments furnishing a single output, the Harrison Laboratories' 6204A and 6206A each provide dual output ranges for increased usefulness. Only 3½ inches high, they occupy minimum bench space. You can also bolt a pair together, add rack mounting ears and use in any standard 19-inch rack, requiring only 3½ inches of vertical space.

The two supplies are similar in characteristics, with the 6204A providing dual outputs of 0 to 18 volts at 0 to 600 milliamps or 0 to 36 volts at 0 to 300 milliamps, while the outputs of the 6206A are 0 to 32 volts at 0 to 1 amp or 0 to 64 volts at 0 to 500 milliamps.

Both feature high regulation, low ripple and noise and high stability. Complete overload protection is provided by a fixed current limit. The instruments are even protected against a direct short across the output terminals. Output terminals include 5-way binding posts on the front panel and a barrier strip on the rear panel. All terminals are floating, and either positive or negative terminal may be connected to the chassis through a separate grounding terminal. Provision is made for error sensing at either front or rear terminals; in addition, terminals for remote sensing are included on the rear terminal strip.

Specifications

- Output: 6204A: 0-18 v dc @ 0-600 ma; 0-36 v dc @ 0-300 ma.
6206A: 0-32 v dc @ 0-1 a; 0-64 v dc @ 0-500 ma.
- Load Regulation: Less than 10 mv change.
Line Regulation: Less than 10 mv change.
Ripple and Noise: Less than 500 μ v rms.
Maximum Operating Temperature: 50°C.
Temperature Coefficient: Less than 0.03% plus 2 mv per °C (using precision wire-wound programming resistor or rheostat).
Stability: For 8 hours after 30-minute warmup at constant ambient temperature, less than .15% plus 10 mv (using precision wire wound programming resistor or rheostat).
Transient Recovery Time: Less than 50 μ sec required for output voltage recovery to within 10 mv of nominal output following a full load change in output current.
Controls: Coarse and fine voltage controls.
Meters: Voltmeter, ammeter available as optional extras.
Remote Programming: Rear panel, 200 ohms per volt, 6204A; 300 ohms per volt, 6206A.
Power: 105-125 v, single phase, 57 to 440 cps.
Size: 6204A, 3½" high, 9" deep, 8¼" wide; 6206A, 3½" high, 13" deep, 8¼" wide.
Weight: 6204A; Net 12 lbs. Shipping 15 lbs.
6206A; Net 18 lbs. Shipping 23 lbs.
Price: Model 6204A, \$99 (add \$20 for meters); Model 6206A \$149 (add \$20 for meters). Rack mounting hardware available.
Data subject to change without notice.

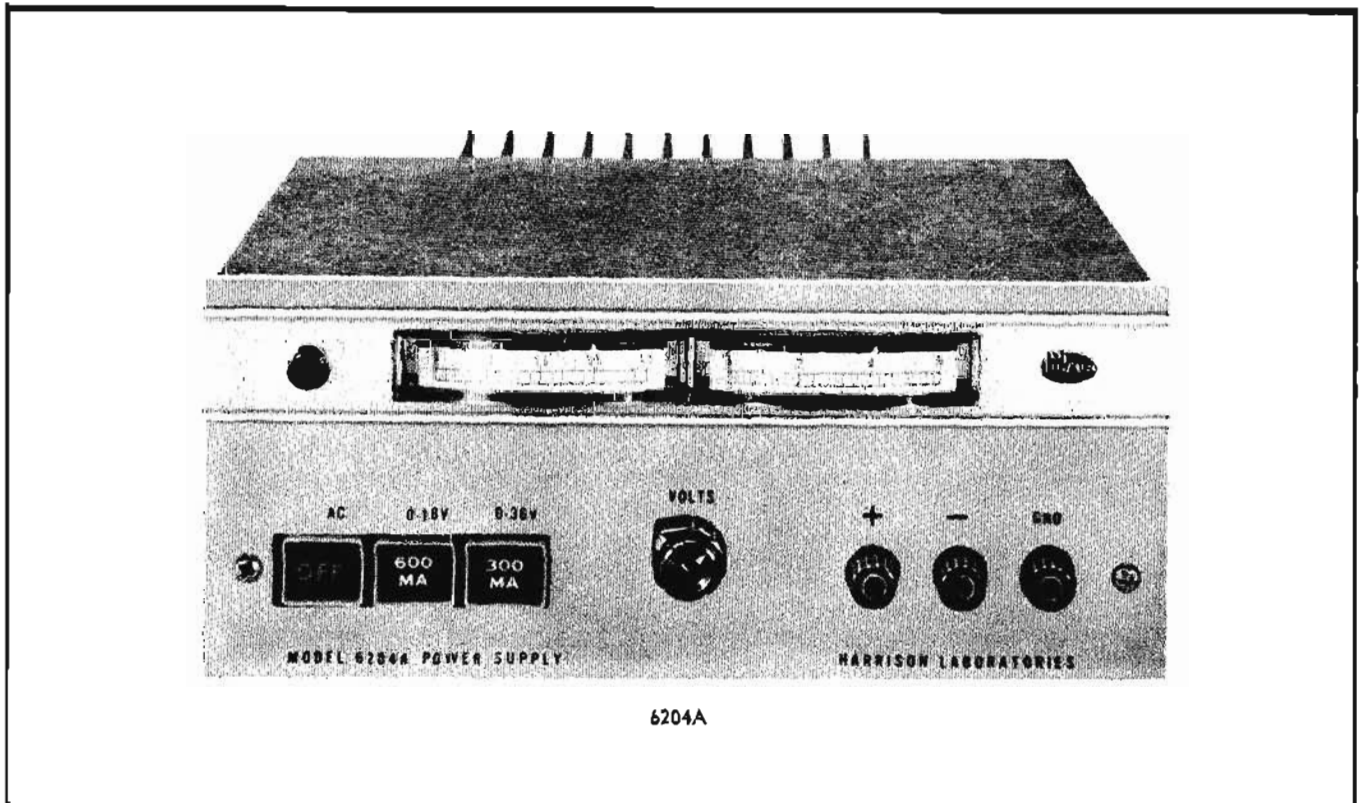

hp 721A, 723A, H Lab 800A-2, 800B-2,

880 Low Voltage Power Supplies

721A Transistor Power Supply

This inexpensive power supply is ideal for use in research and development laboratories, particularly in semiconductor circuit design. It provides fully regulated output voltages 0 to 30 volts. Either positive or negative terminal may be grounded, or the supply may be stacked on another voltage. A meter monitors either voltage or current. High stability and low ripple help assure accuracy. The supply is less than 5" high.

Specifications

Regulated Output: 0 to 30 v dc; 0 to 150 ma dc.
 Load Regulation: Less than 0.3% or 30 mv change (whichever is greater) from 0 to 150 ma.
 Line Regulation: Less than 0.3% or ± 15 mv change (whichever is greater) for $\pm 10\%$ line voltage.
 Noise and Ripple: Less than 150 μ v rms.
 Output Impedance: Less than 0.2 ohms in series with 30 μ h.
 Output Protection: Four step selection of max. current: 25, 50, 100 and 225 ma.
 Power: 115 or 230 v $\pm 10\%$, 50 to 60 cps, 16 watts.
 Dimensions: 7" wide, 4 $\frac{3}{8}$ " high, 5 $\frac{1}{4}$ " deep.
 Weight: Net 4 lbs. Shipping 7 lbs.
 Price: \$145.

723A Power Supply

Ideal for systems applications where a number of tests are made automatically at different voltages, the 723A provides 0 to 40 v dc, 0 to 500 ma dc, and its output may be programmed remotely by using stepping switches to change the value of an external resistor. Output terminals are isolated from the chassis and power line ground.

Specifications

Regulated Output: 0 to 40 v dc, 0 to 500 ma dc.
 Load Regulation: Less than 20 mv change from 0 to 500 ma.
 Line Regulation: Less than 10 mv change for $\pm 10\%$ change in line voltage.
 Noise and Ripple: Less than 150 μ v rms.
 Temperature Stability: Less than 0.05%/°C or 10 mv/°C, whichever is greater.
 Temperature Range: 0 to 55°C for operation within specifications.
 Remote Programming: External resistance can control output voltage at the rate of 50 ohms/v.
 Output Impedance: 40 milliohms in series with 20 μ h.
 Current Limiter: Continuously adjustable from approx. 60 to 600 ma.
 Power: 115 or 230 v $\pm 10\%$, 50 to 1000 cycles.
 Dimensions: 5 $\frac{1}{8}$ " wide, 6-3/32" high, 11" deep.
 Weight: Net 11 lbs. Shipping 21 lbs.
 Price: \$225.



721A

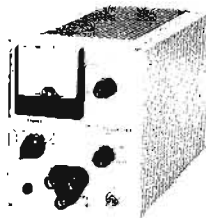

723A

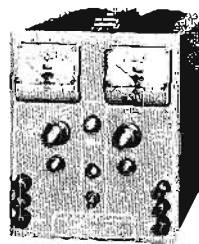

800A-2

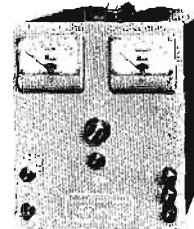

800B-2

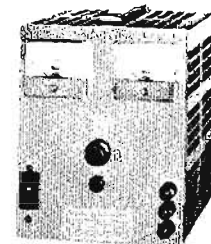

880

H Lab Power Supplies for Low Voltage Lab Application

The H Lab 800A-2 is a twin transistorized supply providing two identical outputs. Either side of each supply may be grounded, and the supplies may be connected in series for doubling the output of an individual supply. The 800B-2 is a 2.5 amp bench supply which provides a continually adjustable output of 0 to 36 volts. The H Lab 880 is a compact supply providing 0 to 100 volts at 0 to 1 amp. It features short recovery time and low impedance as a function of frequency. All three supplies are protected from overload.

	800A-2	800B-2	880
Output (dc)	Two independent supplies, each rated for 0-36 v @ 0-1.5 a	0-36 v @ 0-2.5 a	0-100 v @ 0-1 a
Load Regulation: (no load to full load)	Less than 5 mv change	Less than 10 mv change	Less than 0.02% or 5 mv change (whichever is greater)
Line Regulation: (for line change of 105 to 125 v)	Less than 5 mv change	Less than 5 mv change	Less than 0.05% or 5 mv change (whichever is greater)
Ripple and Noise:	Less than 200 μ v rms	Less than 250 μ v rms	Less than 500 μ v rms
Max. ambient operating temperature:	50°C.	60°C.	60°C.
Stability:	Less than 15 mv drift for 8 hours after 30-min. warmup		Less than 0.05% or 5 mv (whichever is greater) for 8 hours after 30-min. warmup
Meters:	Monitor voltage and current on two separate meters		
Power:	105 to 125 v, 55 to 65 cps	105 to 125 v, 50 to 440 cps	105 to 125 v, 50 to 440 cps
Dimensions:	7" wide, 9" high, 10 $\frac{1}{2}$ " deep	7" wide, 9" high, 10 $\frac{1}{2}$ " deep	7" wide, 9" high, 10 $\frac{1}{2}$ " deep
Weight:	Net 29 lbs. Shipping 32 lbs.	Net 25 lbs. Shipping 30 lbs.	Net 25 lbs. Shipping 30 lbs.
Price:	\$580	\$339	\$375

H Lab 808A, 809A, 881A, 6242A, 6244A, 810B, 814A Constant Voltage/constant current Rack Model Supplies

Seven Harrison Laboratories power supplies provide full range coverage in rack mount constant voltage/constant current instrumentation. Three use a plug-in card to determine whether operation is in the constant voltage or the constant current mode. The other four are automatic cross-over configuration, with the state of operation depending on limit settings of front-panel controls. All seven may be used in Auto-Series, Auto-Parallel operation to increase total voltage and current output, featuring one-knob master control, automatic current and voltage equalizing and full range control from any selected instrument.

H Lab 808A, 809A, 881A

These precision power supplies require only the insertion of a printed circuit plug-in card for determination of constant voltage or constant current mode of operation. All are in rack mount cabinets. Plug-in circuit cards furnished with each instrument provide capabilities for selecting the mode of operation and for use in Auto-Series and Auto-Parallel applications. The only tool needed to select these options is a screwdriver.

Output of the 808A is 0 to 36 v, 0 to 5 a; of the 809A, 0 to 36 v, 0 to 10 a; of the 881A, 0 to 100 v, 0 to 1 a.

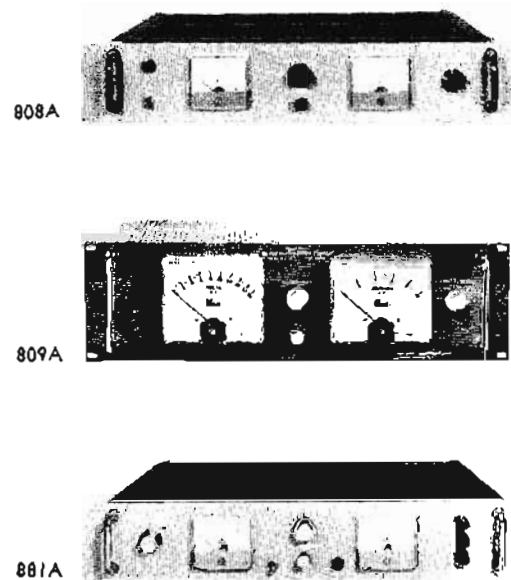

SPECIFICATIONS

	808A	809A	881A
Output (dc)	0-36 v, 0-5 a	0-36 v, 0-10 a	0-100 v, 0-1.0 a
Load Regulation (output change):			
Constant Voltage (whichever is greater)	Less than 0.01% or 3.6 mv for 5 a load change	Less than 0.02% or 7.2 mv for 10 a load change	Less than 0.02% or 5 mv from 0 to 1.0 a
Constant Current (whichever is greater)	Less than 0.1% or 5.0 ma change for 36 v load change	Less than 0.2% or 10 ma change for 36 v load change	Less than 0.02% or 200 μ a change from 0 to 100 v
Line Regulation (105-125 v):			
Constant Voltage (whichever is greater)	Less than 0.01% or 3.6 mv change	Less than 0.02% or 7.2 mv change	Less than 0.05% or 5 mv change
Constant Current (whichever is greater)	Less than 0.1% or 5 ma change	Less than 0.2% or 10 ma change	Less than 0.05% or 100 μ a change
Ripple and Noise:			
Constant Voltage	Less than 500 μ v rms	Less than 500 μ v rms	Less than 200 μ v rms
Constant Current	Less than 3 ma rms	Less than 5 ma rms	Less than 100 μ a rms
Max. Operating Temperature:	50°C	50°C	50°C
Overload Protection:	Current limiter provides protection against overload, including direct short. Front panel control permits continuous adjustment of current from 0 to 110% of current rating		
Controls	Coarse and fine voltage controls; coarse current control		
Meters:	Both voltage and current are monitored in all modes of operation by front-panel meters		
Output Terminals:	Isolated from chassis ground		
Error Sensing:	Normally accomplished at output terminals; extra terminals permit remote sensing		
Remote Programming: (Rear terminal strip)	200 ohms/v, constant voltage 200 ohms/a, constant current	200 ohms/v, constant voltage 100 ohms/a, constant current	200 ohms/v
Power:	105 to 125 v, 67 to 63 cps, single phase		
Dimensions (H, D, W)	3 1/2", 16 3/4", 19"	3 1/4", 16 3/4", 19"	3 1/2", 16 3/4", 19"
Weight (net, shipping)	35 lbs. 42 lbs.	55 lbs. 63 lbs.	35 lbs. 40 lbs.
Price:	\$475*	\$575*	\$475*

*All models available with chopper-stabilized amplifier for improved stability. Designate "X" on model number (i.e., 808AX), add \$125.



6242A

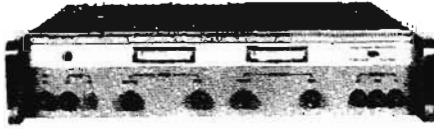

6244A

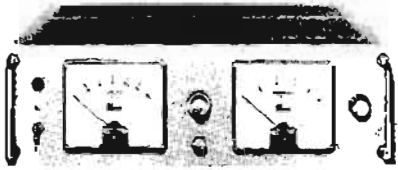

810B

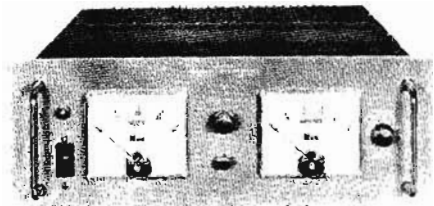

814A

H Lab 6242A, 6244A, 810B, 814A

Offered in rack mount enclosures, these power supplies provide automatic transition between constant voltage and constant current operation, no overshoot on turn-on and turn-off, short circuit and open circuit protection, remote programming, remote error sensing, continuously adjustable limit controls, optional chopper amplifier for improved stability.

The 6242A provides two ranges, 0 to 32 volts at 0 to 2 amps or 0 to 64 volts at 0 to 1 amp, selectable by insertion of a single plug-in printed circuit card. Model 6244A provides a standard output of 0 to 36 volts, 0 to 3 amps. The 810B furnishes 0 to 60 volts at 0 to 7.5 amps, and the 814A is a heavy duty instrument providing 0 to 36 volts at 0 to 25 amps.

Common to the supplies is the automatic transition feature. Each includes a continuously adjustable current limit control which, when the supply is being used as a constant voltage source, allows the maximum output current to be set at any value up to the maximum current rating. Thus, as the load increases, the power supply will act as a regulated voltage source until the current limit point is reached. Then, as the load resistance continues to decrease, the supply will automatically transfer to constant current operation, changing its output voltage to maintain the same value of current.

SPECIFICATIONS

	6242A	6244A	810B	814A
Output (dc)	0-32 v @ 0-2 a, or 0-64 v @ 0-1 a, selectable by plug-in circuit card	0-36 v @ 0-3 a	0-60 v @ 0-7.5 a	0-36 v @ 0-25 a
Load Regulation (no load to full load)				
Constant Voltage (whichever is greater)	Less than 0.02% or 3 mv change	Less than 0.02% or 5 mv change	Less than 0.02% or 10 mv change	Less than 0.03% or 10 mv change
Constant Current (whichever is greater)	Less than 0.1% or 2 ma change	Less than 0.1% or 3 ma change	Less than 0.05% or 3.5 ma change	Less than 0.05% or 12 ma change
Line Regulation (105-125 v)				
Constant Voltage (whichever is greater)	Less than 0.03% or 5 mv change	Less than 0.01% or 2 mv change	Less than 0.01% or 5 mv change	Less than 0.03% or 10 mv change
Constant Current (whichever is greater)	Less than 0.1% or 2 ma change	Less than 0.1% or 3 ma change	Less than 0.05% or 3.5 ma change	Less than 0.05% or 12 ma change
Ripple and Noise (rms)				
Constant Voltage	Less than 200 μ v	Less than 500 μ v	Less than 1 mv	Less than 1 mv
Constant Current	Less than 2 ma	Less than 3 ma	Less than 3 ma	Less than 10 ma
Max. Operating Temperature	50°C	50°C	50°C	50°C
Overload Protection	Current limiter prevents overload damage, including direct short; front panel control permits continuous adjustment of limit from 0 to 110% of rated current			
Controls	Coarse and fine voltage and current controls			
Meters	Both voltage and current are monitored in all modes of operation by front-panel meters			
Output Terminals	Isolated from ground, front and rear terminal		Isolated from ground, rear terminal only	
Error Sensing	Rear or front-panel terminals, or remote		Rear terminal or remote	
Remote Programming (Rear terminal strip)	300 ohms/v 125 - 250 ohms/a	200 ohms/v 80 ohms/a	300 ohms/v 20-25 ohms/a	200 ohms/v 10 ohms/a
Power	105 to 125, 210 to 250 v ac, 50 to 400 cps	105 to 125, 210 to 250 v ac, 50 to 70 cps	105 to 125 v ac, 57 to 63 cps	
Dimensions (H, D, W)	3 1/2", 16 3/4", 19"	3 1/2", 16 3/4", 19"	5 1/4", 16 3/4", 19"	7", 18 3/8", 19"
Weight (net, shipping)	25 lbs. 30 lbs.	25 lbs. 30 lbs.	60 lbs. 67 lbs.	90 lbs. 100 lbs.
Price	\$349*	\$365*	\$795*	\$775*

*All models available with chopper-stabilizer amplifier for improved stability. Chopper stabilization improves only constant voltage operation in Models 6242A, 6244A and 810B, and designation "X" should be added to model number when ordering. On Model 814A, either designation "XV" or "XC" should be used to indicate whether improvement in performance is desired in constant voltage operation or constant current operation. On Model 810BX, improvement in performance is obtained in constant voltage only. Prices 6242AX, \$474; 6244AX, \$490; 810BX, \$920; 814AX, \$900.

H Lab 802B, 812C, 726AR Low Voltage Rack Power Supplies

These three utility power supplies, offered at modest cost, are ideal for low voltage applications such as large scale component and module testing. All are highly regulated, dependable instruments.

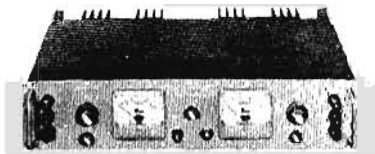

802B

H Lab 802B Twin Transistorized Supply

The 802B furnishes two independent outputs, 0 to 36 volts at 0 to 1.5 amps, that may be connected in series to furnish 0 to 72 volts at any current up to 1.5 amps. Its short recovery time and low impedance as a function of frequency make it suitable for applications involving square wave or pulsed loading and insure a minimum of mutual coupling effects between circuits using a common dc source. Ideal for work on transistor circuitry, it will exhibit no output voltage overshoot when the ac power is turned on or off.

Specifications

Output: Two independent supplies, each rated for 0 to 36 v dc @ 0 to 1.5 a.
Load Regulation: Less than 0.01% or 3.6 mv change, whichever is greater, no load to full load.
Line Regulation: Less than 0.01% or 3.6 mv change, whichever is greater, 105 to 125 v line voltage change.
Ripple and Noise: Less than 200 μ v rms.
Maximum Ambient Operating Temperature: 50°C.
Stability: Less than 15 mv total drift for 8 hours after 20-minute warmup.
Overload Protection: Current limiter protects supply from all overloads, including direct short.
Controls: Coarse and vernier for continuous control of each supply.
Meters: Voltmeter and ammeter monitor output of either supply.
Remote Error Sensing: At rear panel.
Power: 105 to 125 v, 55 to 440 cps.
Dimensions: 3½" high, 15" deep, 19" wide.
Weight: Net 28 lbs. Shipping 34 lbs.
Price: \$580.

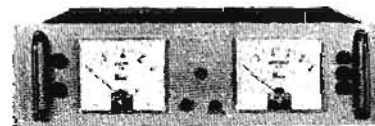

812C

H Lab 812C High Current Supply

This reliable transistorized rack mount supply is designed primarily for high current fixed voltage applications. The output voltage is variable (by means of a front panel screwdriver control) over any of a number of narrow spans which cover the entire output range of 0 to 32 v. The output current rating is 0 to 10 amps at any output voltage.

When ordering, be sure to specify last number (e.g., 812C1 or 812C2, etc.). Any 812C supply may later be changed to a supply of a different suffix by changing a transformer tap and following strapping instructions given in the manual.

Specifications

Output: 0 to 10 amps at any fixed voltage from 0 to 32 v:

Model	Range	Model	Range
812C1	0-6 v	812C1X	1-7 v
812C2	5-11 v	812C2X	6-12 v
812C3	11-17 v	812C3X	12-18 v
812C4	17-21.5 v	812C4X	18-22.5 v
812C5	21.5-25 v	812C5X	22.5-26 v
812C6	25-28 v	812C6X	26-29 v
812C7	28-30.5 v	812C7X	29-31.5 v
812C8	30.5-32 v		

Load Regulation: Less than 0.05% or 0.016 v change, whichever is greater, no load to full load.

Line Regulation: Less than 0.03% or 0.01 v change, whichever is greater, 105 to 125 v line voltage change.

Ripple and Noise: Less than 1 mv rms.

Stability: Less than 20 mv drift for 8 hours after 30-minute warmup.

Overload Protection: Current limited for complete protection, even with a direct short. Also fuse protected from prolonged overload.

Controls: Front-panel screwdriver for variation within limits of each model number above.

Meters: Voltmeter and ammeter monitor output.

Error Sensing: Front or rear terminal. Remote error sensing at rear terminal.

Power: 105 to 125 v, 50 to 65 cps.

Dimensions: 5¼" high, 16" deep, 19" wide.

Weight: Net 52 lbs. Shipping 65 lbs.

Price: \$550.

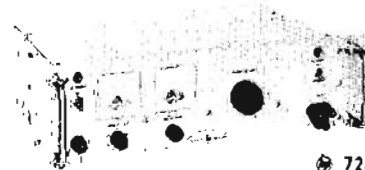

726AR

726AR Power Supply

Remote programming capability and a full 2-amp current capacity make the 726AR ideal for large scale component testing. Remote programming allows output voltage, 0 to 60 v, to be selected by the value of resistance applied between two rear panel terminals. In operation this resistance can be applied by a stepping switch.

Specifications

Output: 0 to 60 v at 0 to 2 a.

Load Regulation: Less than 5 mv change, no load to full load.

Line Regulation: Less than 2.5 mv change for \pm 10% line voltage change.

Ripple and Noise: Less than 250 μ v rms.

Temperature Range: 0 to 55°C.

Remote Programming: Rear panel terminals, 100 ohms/volt.

Overload Protection: Current limiter adjustable 100 ma to 2 amps.

Meters: Separate meters monitor voltage and current output.

Power: 115 or 230 v \pm 10%, 50 to 60 cps, 40 to 250 watts.

Dimensions: 5¼" high, 12" deep, 19" wide.

Weight: Net 25 lbs. Shipping 38 lbs.

Price: \$545.

Data subject to change without notice.

H Lab Modular Plug-In Power Supplies

6343A Series

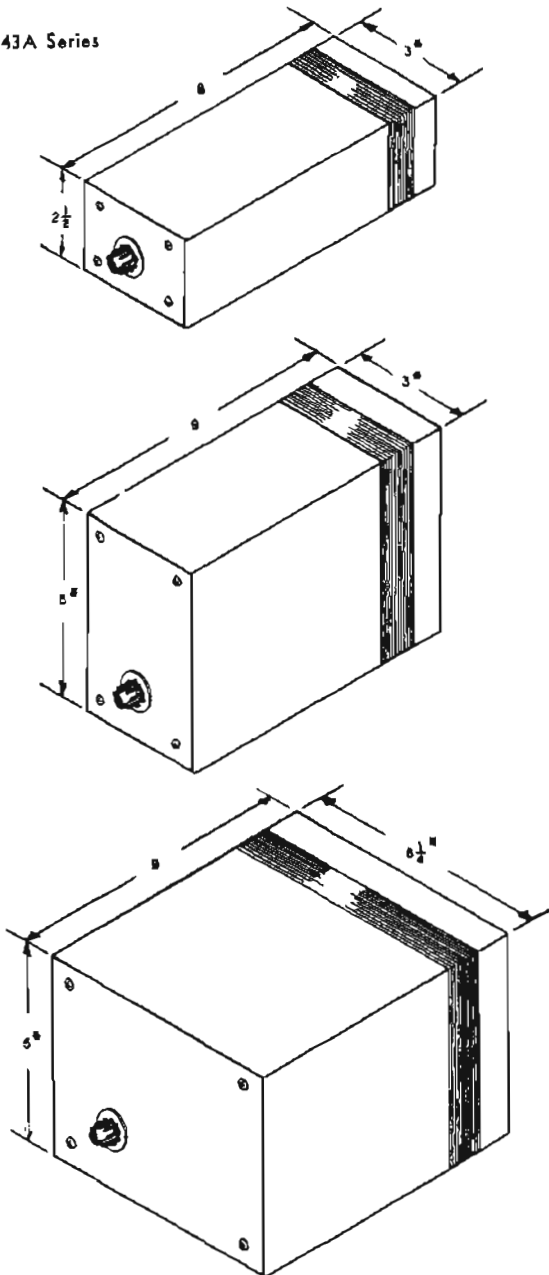

Harrison Laboratories 6340 Series dc supplies are well regulated chassis-mounting power sources at modest cost. These supplies can also be efficiently grouped on rack panels. All input connections are made by means of an 11-pin plug mounted at one end of each supply. Since the output of the supply is determined by the resistance connected between two of the pins, the output can be made continuously variable over its entire range, variable over a limited range, or fixed.

All supplies offer local and remote error sensing and remote programming. Overload protection is supplied by a continuously variable current limiter covering the entire output range of each instrument. Auto-Series operation is possible using a modified strapping pattern on the connecting plug, as is Auto-Parallel operation.

The supplies are designed so that each unit requires twice the mounting area of the next smaller unit (e.g., two A size supplies will fit in the space required for one B size supply). This greatly facilitates the packaging of mixed model numbers in a limited space for multi-voltage systems. Rack mounting assemblies are available for mixed model accommodation, where the user intends other than chassis-mount application.

Specifications

Model	Size	Output Rating	Weight (lbs.)		Price
			Net	Shipping	
6343A	A	0-18 v @ 0-300 ma	5	10	\$120
6344A	B	0-18 v @ 0-1 a	15	21	\$165
6345A	C	0-18 v @ 0-2.5 a	25	35	\$225
6346A	A	0-36 v @ 0-150 ma	5	10	\$120
6347A	B	0-36 v @ 0-500 ma	15	21	\$165
6348A	C	0-36 v @ 0-1.5 a	25	35	\$225

Guide to Dimensions: A—2½" high x 8" deep x 3⅛" wide.

(Overall including screwheads but not including plug.) B—5⅛" high x 9" deep x 3⅛" wide.

C—5⅛" high x 9" deep x 6⅜" wide.

Load Regulation: Less than 3 mv or 0.02% change, whichever is greater, no load to full load.

Line Regulation: Less than 3 mv or 0.02% change, whichever is greater, 105-125 v change.

Ripple and Noise: Less than 1 mv rms.

Operating Temperature Range: 0 to 50°C.

Storage Temperature Range: -20 to +65°C.

Stability: Less than 0.1% plus 6 mv total drift for 8 hours after 30-minute warmup.

Power: 105 to 125 v, 210 to 250 v, 57 to 63 cps.

Terminal Designations: 1 A2 (for remote programming, Auto-Series, etc.)

2 Positive Sensing

3 Positive Output

4 Positive Output

5 AC in

6 Ground

7 AC Common

8 Negative Output

9 Negative Output

10 Negative Sensing

11 A1 (strapped to A2 in normal operation)

Data subject to change without notice.

H Lab 505A, 510A, 520A, 6455A

Rugged SCR Supplies

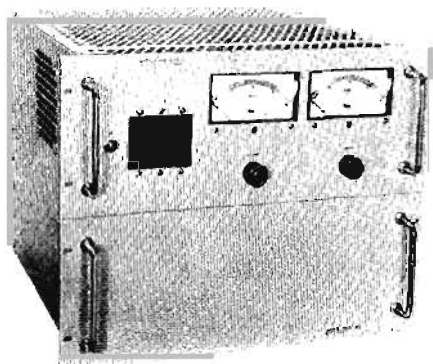

6455A

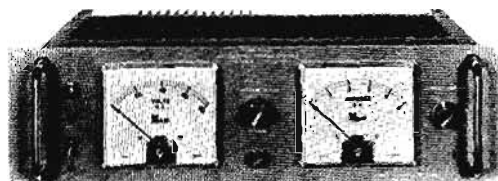

505A

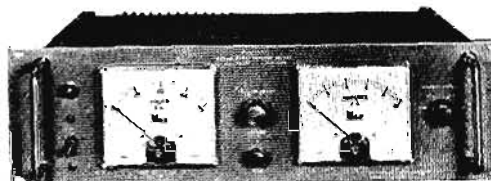

510A

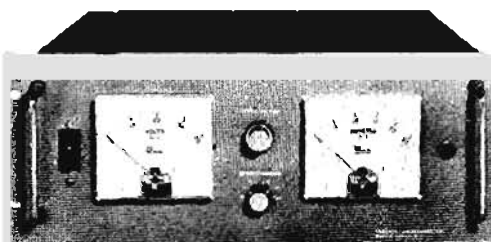

520A

Here are four SCR supplies for applications which require a fixed or continuously variable dc power with moderate regulation and high efficiency and reliability. The unique circuitry in these supplies has a degree of immunity to line voltage transients far in excess of magnetic amplifier type power supplies and better than that found in other supplies having comparable static regulation characteristics.

Features include small size and reduced weight, output voltage continuously variable from 0 to maximum, 50 millisecond recovery for load current changes, continuously variable current limit control, remote programming and error sensing, Auto-Series and Auto-Parallel operation, 75% efficiency at full load.

Data subject to change without notice.

Specifications	505A	510A	520A	6455A
Output (dc)	0-72 v 0-5 a	0-36 v 0-10 a	0-36 v 0-25 a	0-36 v 0-75 a
Combined Load and Line Regulation for a change in output current from half to full load or full to half load with a $\pm 10\%$ change in line voltage	0.5%	0.5%	0.5%	0.5%
Ripple and Noise (rms maximum)	1%	1%	1%	0.5%
Maximum Ambient Operating Temperature	50°C	50°C	40°C, derated linearly to 22.5 a out at 50°C	50°C
Meters (2% accuracy)	80 v, 5 a	40 v, 10 a	40 v, 25 a	40 v, 80 a
Power (57 to 63 cps)	105-125 v single phase	105-125 v single phase	105-125 v single phase	200 or 220 v $\pm 10\%$ three phase
Input Terminals	3-wire power cord	3-wire power cord	barrier strip	4 terminal "twist-lock" connector
Output Terminals	barrier strip	barrier strip	barrier strip	tapped rectangular bus bars
Dimensions (19" standard rack width)	5 1/4" high 12" deep	5 1/4" high 12" deep	7" high 16 1/2" deep	14" high 17" deep
Weight (net/shipping, lbs.)	50-60	50-60	65-95	225-300
Price:	\$475	\$450	\$575	\$1450
Stability:	Less than 0.3% plus 60 mv drift over 8 hours (after 30-minute warmup).			
Controls:	Single control for continuous adjustment over the entire range. Models 505A, 510A incorporate additional vernier			
Remote Error Sensing:	Rear panel			
Remote Programming:	Rear barrier strip permits external control of output voltage over entire range with 1000-ohm potentiometer and of output current with 250-ohm rheostat.			

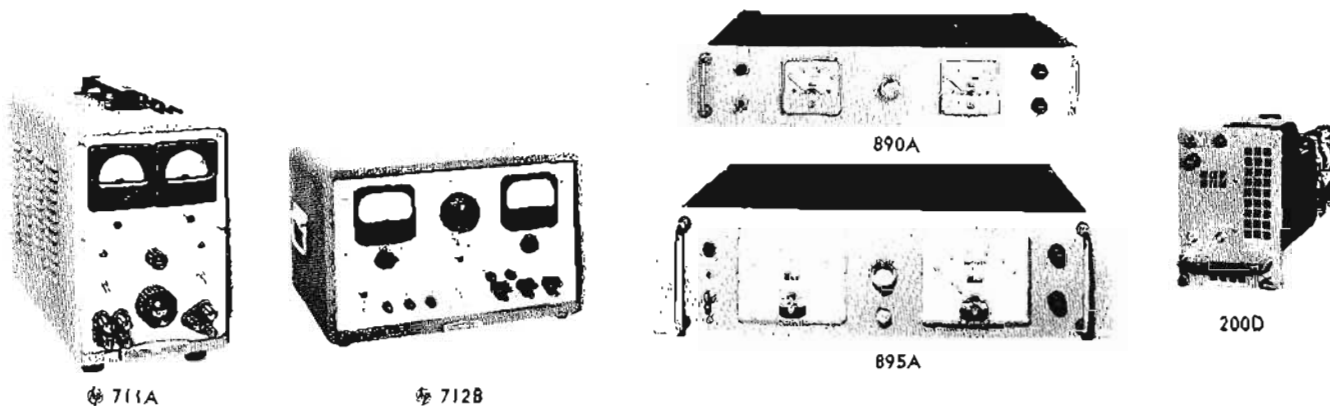

hp 711A, 712B, H Lab 890A, 895A, 200D Supplies

Useful for DC Applications Over 100 V, Less Than 1000 V

These easy-to-use power supplies are particularly suited for "medium" voltage requirements. Each offers fine performance and broad use at moderate price.

hp 711A Power Supply, 0 to 500 V

Here is a highly regulated supply particularly useful for experimental setups and basic bench applications, furnishing an output of 0 to 500 v dc, 100 ma maximum load. Also provided are outputs of 6.3 v rms at 6 amps or 12.6 v rms CT at 3 amps. Regulation is 0.5% or 1 v change, whichever is greater, no load to full load, or for line voltage changes of $\pm 10\%$. Ripple is less than 1 mv.

Meters monitor output current and voltage. Overload protection includes fused ac line, plus relay for current meter. Input is 115 or 230 v $\pm 10\%$, 50 to 1000 cps, approximately 145 watts.

Cabinet mount is 7 $\frac{3}{8}$ " wide, 11 $\frac{1}{2}$ " high, 14 $\frac{1}{4}$ " deep, while the rack mount model is 7" high, 13" deep and 19" wide. Weight, net 20 lbs., shipping 26 lbs. (cabinet); net 24 lbs., shipping 35 lbs. (rack mount). hp 711A, \$250 (cabinet); hp 711AR, \$255 (rack mount).

hp 712B Four-Output Supply

The hp Model 712B furnishes 0 to 500 volts dc, 200 ma maximum load, plus three other outputs; a dc regulated fixed bias of -300 volts, 50 ma maximum load; dc variable bias of 0 to -150 volts, 5 ma maximum load, and unregulated ac, 6.3 volts CT, 10 amps maximum load. Regulation is less than 50 mv, no load to full load. Ripple and noise are less than 500 microvolts.

Both voltage and current outputs are monitored by front panel meters, and overload protection is provided. Power 115 volts $\pm 10\%$, 50 to 60 cps, 120 to 450 watts, depending on load and line voltage. The cabinet model measures 12 $\frac{3}{4}$ " high, 20 $\frac{3}{4}$ " wide and 14 $\frac{3}{4}$ " deep, while the rack mount model measures 19" wide, 10 $\frac{1}{2}$ " high and 13 $\frac{3}{8}$ " deep. Price, hp 712B, \$390 (cabinet); hp 712BR, \$375 (rack mount).

H Lab 890A: Solid State, 0-320 Volts, 0-600 Milliamps

The H Lab 890A is a compact general purpose regulated dc power supply that provides an output of 0 to 320 volts

at 0 to 0.6 amps. The output voltage is continuously variable with a single control, and the supply is completely solid state. Low output impedance and fast transient response make it suitable for pulse or square wave loading. Overload protection is provided, and provisions are included for remote programming and error sensing.

Load regulation is less than 0.007% or 0.02 volts (whichever is greater), no load to full load, and line regulation is the same for an input change from 105 to 125 v ac. Ripple and noise less than 2 millivolts rms. Standard relay rack mounting, 3 $\frac{1}{2}$ " high, 16 $\frac{3}{4}$ " deep and 19" wide. Price, \$445. (For chopper-stabilized amplifier specify Model 890AX, \$570.)

H Lab 895A: Solid State, 0-320 Volts, 0-1.5 Amps

Similar to the H Lab 890A, output is 0 to 320 volts, 0 to 1.5 amps.

Model 895A is standard 19" rack width, 5 $\frac{1}{4}$ " high and 16 $\frac{3}{4}$ " deep. The 895A is priced at \$625, the 895AX at \$750.

H Lab 896A: Solid State, 75-160 Volts, 0-25 Amps

Similar to 890A and 895A. Load regulation is less than 0.02% or 30 mv (whichever is greater) and line regulation is also 0.02% or 30 mv. 5 $\frac{1}{4}$ " high, 16 $\frac{3}{4}$ " deep, 19" wide. Model 896A, \$675, Model 896AX, \$800.

H Lab 200D Plug-in Vacuum Tube Supplies

Two models of the 200D are offered, the 200D standard, 150 to 315 volts dc at 0 to 0.8 amp, and the 200DX, 100 to 260 volts dc at 0 to 0.8 amp. The ranges are covered in a series of spans, rather than continuously, approximately $\pm 10\%$ from any nominal value within the range. The plug-in case will accommodate up to three supplies side by side in standard rack mount (panel height required, 8 $\frac{3}{4}$ ").

Load regulation, no load to full load, is less than 0.03 v change. Line regulation is ± 0.06 v for a $\pm 10\%$ line change. Ripple and noise is less than 1.5 mv rms. Price, 200D, \$275; 200DX, \$295. Type 10 case, \$168.

Data subject to change without notice.

H Lab 6920A Meter Calibrator, 801C Strain Gage Power Module, 6910A Dual Crowbar Protector

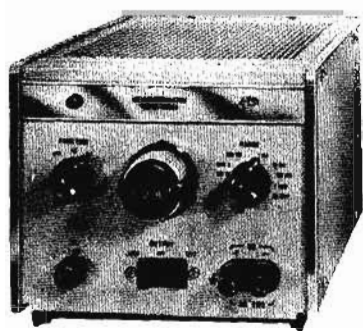

H Lab 6920A Meter Calibrator

For checking meters, the H Lab Model 6920A Meter Calibrator is a fully protected instrument that simply and conveniently calibrates dc voltmeters, up to 1000 volts; ac voltmeters, up to 1000 volts; dc ammeters, up to 5 amps; ac ammeters, up to 5 amps.

The 6920A, packaged for convenient bench use, occupies half of a standard rack width, with 7 inches vertical space, and provides outputs for lab or production testing of panel meters, multimeters and other meters with an accuracy of the order of 1% or more. It is capable of both constant voltage and constant current output.

An output switch selects the safest mode of operation for the particular type of meter being tested. A "lock" position leaves the testing parameters in operation to free both hands for attaching and disconnecting successive meters. A "test" position, springloaded so that the meter calibrator output is presented on the terminals only while finger pressure is applied, facilitates testing meters with several full-scale values and reduces the danger of burn-out.

Specifications

Output Voltage Ranges (ac or dc): 0 to 1 v, 0 to 5 a; 0 to 10 v, 0 to 1 a; 0 to 100 v, 0 to 100 ma; 0 to 1000 v, 0 to 10 ma.

Output Current Ranges (ac or dc): 0 to 100 μ a, 0 to 500 v; 0 to 1 ma, 0 to 500 v; 0 to 10 ma, 0 to 500 v; 0 to 100 ma, 0 to 50 v; 0 to 1 a, 0 to 5 v; 0 to 5 a, 0 to 0.5 v.

Output Accuracy: dc: 0.2% of set value, plus 0.05% of range switch setting; ac: 0.4% of set value, plus 0.1% of range switch setting. Accuracy applicable over temperature range of 15° to 35°C.

Controls:

Function Switch: Off, AC, DC.

Range Switch: 10 positions, one for each voltage and current range.

Calibrated Output Control: Digital potentiometer readout-control (3 digits) determines exact value of output.

Output Switch: Center position disconnects output terminals. Left side connects output terminals to meter calibrator continuously. Right side connects output terminals to meter calibrator only as long as pressure is applied.

Power: 105 to 125 v, 50 to 70 cps.

Dimensions: 6 $\frac{3}{4}$ " high, 7-13/16" wide, 11" deep.

Weight: Net 15 lbs. Shipping 23 lbs.

Price: Price on request.



801C

H Lab 801C Strain Gage Power Module

Designed to operate primarily as a power supply for strain gage applications, the 801C is a solid state power supply whose design, construction and size permit extreme isolation from ground and the ac power line . . . greater than 10,000 megohms to ground or ac input and less than 1 pf capacity from output terminals to input power line. Remote error sensing provisions. Using many supplies to feed a large number of strain gages provides excellent isolation capabilities, and the shortening of a single strain gage will not disrupt the entire test setup.

Output is 0 to 25 volts, 0 to 0.2 amps. Regulation is less than 0.002 volts change, no load to full load or for a change in line voltage from 105 to 125 v. Ripple and noise are less than 100 microvolts rms.

The 801C is 5" high, 14 $\frac{7}{8}$ " deep and 1 $\frac{5}{8}$ " wide, for convenient mounting in rack configurations.

Price: 1 to 9, \$149 each.

10 to 49, \$145 each.

50 to 99, \$140 each.

100 and more, \$135 each.

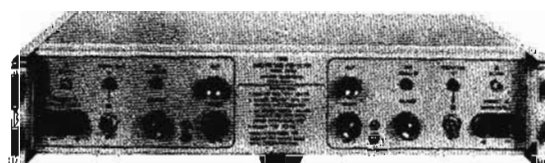

6910A

H Lab 6910A Dual Crowbar Protector

The Model 6910A provides two identical but independent overvoltage protection circuits in one package . . . to give maximum assurance that power supply built-in overload protectors will not damage external circuitry or components, should the internal protectors fail.

The protected load device is shunted by a virtual short circuit within 5 microseconds after the adjustable voltage threshold is exceeded. Protection action also opens relay contacts in series with the ac power into the power supply and generates an output pulse for operating other crowbars in tandem. The crowbar can be checked in a system without shutting down the operation.

The 6910A incorporates a silicon controlled rectifier connected across the terminals of the load device. The desired overvoltage increment, 0 to 6 v, is set on a front panel control of the 6910A. The protector can be used with any power supply with an output voltage of less than 72 volts and an output power of less than 450 watts. Easily adapted to bench use, the 6910A is 3 $\frac{1}{2}$ " high, 11 $\frac{1}{4}$ " deep and 19" wide for convenient rack use. Price, 6910A, \$345; 6910AM (for use with additional power supplies H Lab 520A and 814A), \$375.

Data subject to change without notice.

hp 715A, 716A KLYSTRON POWER SUPPLIES

Versatile Power Sources for Wide Range of Klystrons

The new hp 716A Supply offers superior regulation, noise, ripple and hum characteristics plus the broad capability of powering at least 250 types of klystrons. Beam and reflector voltages are closely regulated and continuously adjustable using calibrated controls accurate to within $\pm 2\%$ on beam voltage and to within $0.5\% \pm 1$ volt on repeller voltage. In addition, a regulated dc filament supply minimizes residual FM and AM from the klystrons.

The dc filament supply, regulated and adjustable, combines with a beam voltage ripple of less than 1 mv and a reflector voltage ripple of less than 500 μ v to assure minimum frequency and amplitude modulation of the klystron and extreme klystron frequency stability. The reflector supply can be internally modulated with a sawtooth for FM or with a square wave for on-off operation. The positive excursion of the square wave is clamped to the reflector voltage. Sawtooth and external modulation are ac coupled to the reflector. A protective diode prevents the klystron reflector voltage from becoming positive with respect to the cathode. Panel BNC connectors provide a constant amplitude output for scope sync, input of external modulation signals and a sync input signal for increased modulation stability.

The hp 715A, designed to operate many types of low-power klystrons, offers a regulated 250 to 400 volt beam voltage, a 0 to 900 volt regulated reflector supply and a 6.3 volt ac filament supply. The reflector supply can also be square-wave modulated internally at the nominal frequency of 1000 cps, externally modulated or sine wave modulated at the power line frequency. Klystron protection is built in.

Specifications

715A	716A
<p style="text-align: center;">Reflector Supply</p> <p>0 to 900 v negative with respect to beam supply, calibrated voltage controls; regulation within $1\% \pm 10\%$ line voltage variation; ripple less than 10 mv.</p>	<p style="text-align: center;">Reflector Supply</p> <p>0 to 800 v negative with respect to beam supply, accuracy $\pm 0.5\%$ of dial reading ± 1 volt; line regulation better than 0.05%; ripple less than 500 μv.</p>
<p style="text-align: center;">Beam Supply</p> <p>250 to 400 v negative with respect to chassis ground, calibrated voltage controls; current 30 ma max. at 250 v, 50 ma max. at 400 v; regulation better than 1% no load to full load or for $\pm 10\%$ nominal line voltage variation; ripple less than 7 mv.</p>	<p style="text-align: center;">Beam Supply</p> <p>250 to 800 v negative with respect to chassis ground, accuracy $\pm 2\%$ of dial reading; current 100 ma max.; line regulation better than 0.1%; load regulation better than 0.05%; ripple less than 1 mv.</p>

715A	716A
<p style="text-align: center;">Filament Supply</p> <p>6.3 v ac, 1.5 amp maximum.</p>	<p style="text-align: center;">Filament Supply</p> <p>6.3 v dc, adjustable and isolated from ground; current 0 to 2 amp; ripple less than 15 mv; line regulation better than 1%.</p>
<p style="text-align: center;">Internal Modulation</p> <p>Square wave: 1000 \pm 100 cps, adjustable; 0 to 110 v p-p, negative from reflector voltage; less than 10 μs rise and decay times. Sinusoidal: power line frequency, 0 to 350 v p-p.</p>	<p style="text-align: center;">Internal Modulation</p> <p>Square wave: 400 cps to 2.5 kc; 0.1% short term stability; 10 to at least 150 v p-p, negative from reflector voltage; 5 μs rise time. External sync of internal square wave 10 v peak, 500K nominal input impedance. Sawtooth: 75 cps nominal, 0 to at least 150 v nominal p-p, ac coupled to reflector.</p>

715A	716A
<p style="text-align: center;">External Modulation</p> <p>Terminals provided; input impedance 100K.</p>	<p style="text-align: center;">External Modulation</p> <p>Max. input 200 v p-p; input impedance 500K, 100 pf nominal.</p>

715A	716A
<p style="text-align: center;">Oscilloscope Output</p> <p>With internal square wave modulation: 1 v p-p min. for scope sync, 600 ohms output impedance. With internal sawtooth modulation: 10 v p-p min. for scope sweep, 50K output impedance.</p>	<p style="text-align: center;">Oscilloscope Output</p> <p>With internal square wave modulation: 1 v p-p min. for scope sync, 600 ohms output impedance. With internal sawtooth modulation: 10 v p-p min. for scope sweep, 50K output impedance.</p>

715A	716A
<p style="text-align: center;">Meter</p> <p>Monitors beam current 0 to 50 ma.</p>	<p style="text-align: center;">Meter</p> <p>Monitors beam current 0 to 50 ma.</p>
<p style="text-align: center;">Power</p> <p>115 or 230 v $\pm 10\%$, 50 to 60 cps, 200 watts.</p>	<p style="text-align: center;">Power</p> <p>115 or 230 v $\pm 10\%$, 50 to 60 cps, 200 to 350 watts.</p>
<p style="text-align: center;">Dimensions</p> <p>7$\frac{3}{8}$" wide, 11$\frac{1}{2}$" high, 13$\frac{3}{4}$" deep.</p>	<p style="text-align: center;">Dimensions</p> <p>16$\frac{3}{4}$" wide, 7$\frac{1}{2}$" high, 18$\frac{3}{8}$" deep. Hardware furnished for rack mounting.</p>
<p style="text-align: center;">Weight</p> <p>Net 19 lbs. Shipping 24 lbs.</p>	<p style="text-align: center;">Weight</p> <p>Net 45 lbs. Shipping 62 lbs.</p>
<p style="text-align: center;">Accessories Furnished</p> <p>715A-16C Shielded Output Cable, for connection to klystron.</p>	<p style="text-align: center;">Accessories Furnished</p> <p>4' cable, terminated end mates with 716A.</p>
<p style="text-align: center;">Price</p> <p>\$325.</p>	<p style="text-align: center;">Price</p> <p>\$775.</p>

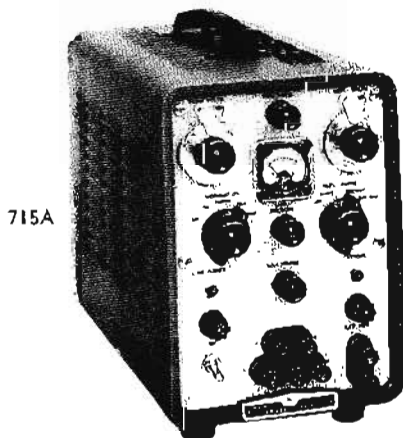

715A

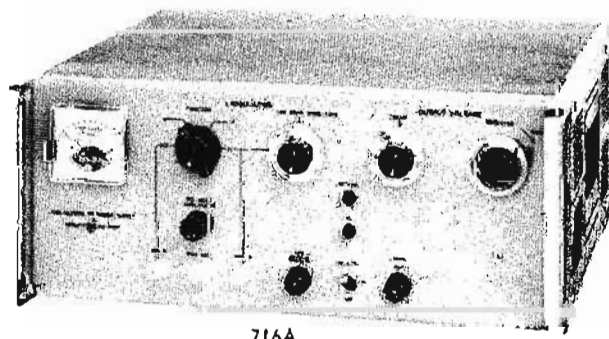

716A

NEW IN THIS CATALOG

INDEX BY INSTRUMENT FUNCTION

<i>Instrument</i>	<i>Page</i>	<i>Instrument</i>	<i>Page</i>
Accessories	111	Bridge, VHF	234
Modular Enclosure	18-19	Bridging Amplifier	112
Oscilloscope	50-51, 54-55	Bridging Transformer	111
Voltmeter	109	Broadband Probe	236-238
AC Power Supply, Variable	242	Cabinets, Modular	18-19
AC Voltmeters	88-92, 94-97	Cables, Test Leads	111
AC-to-DC Converter	17, 102	Calibrators:	
AC/Ohms to DC Converter	103	Ammeter	256
Adapters:		Power Meter	197
BNC-to-Binding Post	55, 111	Signal Generator	13
Cover-to-Choke Flange	179	Voltmeter	110, 256
Rack (for small modular instruments)	18-19	Calorimetric Power Meter	200-201
Waveguide-to-Coaxial	179	Cameras, Oscilloscope	53
Waveguide-to-Waveguide	179	Capacitive Voltage Dividers	109
Adjustable Short, Waveguide	241	Carriages, Universal Probe	236-238
Ammeters	95, 98, 100, 106-108	Carrier Test Oscillator	72
Aircraft Communications Test Equipment	13	Carrier-type Recorder	9
Amplifiers:		Chart Advance, X-Y Recorders	16
AC, Transistorized	112	Choke-to-Cover Flange Adapter	179
Bridging	112	Clamps, Waveguide	179
Data	114-116	Clip-on DC Milliammeters	106-107
Distributed, Wideband	113	Clocks, Digital	15, 148
DC	114-117	Clocks, Frequency Dividers and	159
Fast-Pulse	113	Coaxial:	
FIFO	114-116	Adapters, Waveguide	179
General Purpose, Stabilized	112	Attenuators	189
Guarded Data	103	Detector Mounts	193, 236-237
Leveler	197	Directional Couplers	189, 232-233
Narrow-band DC	116	Frequency Meters	204
Oscilloscope Plug-in	32-33, 36-37, 40-41, 48-49	Low Pass Filters	186
Traveling-Wave Tube	202-203	Shorts	239
Video (for hp 524, 5243L, 5245L Counters)	130-131, 139-140	Slide-Screw Tuner	239
Analyzers, Distortion and Waveform	78-83	Slotted Sections	235-237
Attenuators:		Terminations	241
Fixed, Waveguide	187	Combining Cases	18-19
Precision	187-189	Communications Systems Test Set	93
Tee	118, 189	Converter:	
Variable, Coaxial	189	Frequency	130, 139-143
Variable, Waveguide	187-188	AC-to-DC	17, 102
Audio Frequency Analyzers:		AC/Ohms to DC	103
Distortion	82-83	Peak Voltage to Logarithm	17
Wave	78-79	Microwave Frequency	141
Audio Frequency Oscillators	68-76	Voltage to Frequency	15
Audio Frequency Signal Generators:		Cooling Kits	18-19
High Power Audio Tests	74	Counters, Electronic	103, 124-140
High Quality, High Accuracy Tests	75	Couplers, Card Punch, Tape Punch	15
Barretter Mounts	191, 193	Couplers, Directional	189, 232-233
Bolometer Mounts	191, 193, 196, 199	Crystal Detectors	191, 193, 236-237
		Current Probe	54, 106-108
		Data Handling Systems	9-11, 14-15

<i>Instrument</i>	<i>Page</i>
DC Ammeters	95, 98, 100, 106-107
DC Amplifiers	114-117
DC Recorder	9
DC Voltage Divider	109
DC Voltmeters	17, 94-95, 98-101, 103-105
Delay Generator, Digital	62
Delay Generators, Oscilloscope Sweep	37, 42
Delay Line	51
Demodulator Recorder	9
Detector Mounts:	
Coaxial	193, 236-237
Waveguide	191, 193
Detector, VHF	234
Digital:	
Clocks	15, 148, 159
Comparator	15
Data Handling Systems	14-15
Delay Generator	62
Printer	148
Recorders	144-147
Voltmeters	101, 103-105
Direct Writers, Portable	9
Direct Writing Systems	10
Directional Couplers	189, 232-233
Display Scanner, Oscilloscope	43
Distortion Analyzers	78-83
Distortion and Noise Meters	82-83
Distributed Amplifiers	113
Doubler Sets, Frequency	226-227
Dual Crowbar Protector	256
E-H Tuner	239
Electronic Counters	103, 124-140
Electronic Tachometer	150-151
Enclosures, Modular	18-19
Event Recorders	11
Fast-Pulse Amplifiers	113
FIFO Amplifiers	114-116
Filler Panels	18-19
Filters, Low Pass	186
Fixed Waveguide Attenuators	187
Force Transducers	11
Frame, Rack Adapter	18-19
Frequency:	
Converters	130, 139-143
Counters	103, 124-140
Dividers and Clocks	159
Doubler Sets	226-227
Measuring System	141
Meters	150, 204
Response Test Set	110

<i>Instrument</i>	<i>Page</i>
Standards	156-158
Synthesizer	154-155
Function Generator, Low Frequency	73
Generators:	
Digital Delay	62
Pulse	58-62
Signal, FM-AM	13
Signal, High Frequency	13, 210-229
Signal, Low Frequency	74-76
Square Wave	57
Tachometer	151
H-Band Test Set	230
Harmonic Mixers	143
Harmonic Wave Analyzer	78-81
High Frequency Wave Analyzers	80-81
High Power Waveguide Terminations	241
Indicators, Standing Wave	190-191
Industrial Electronic Counters	134
Interpolation Oscillator	72
Inverters, DC-to-AC	242
JAN Standard Tables	164
Keyboard	17
Klystron Power Supplies	257
Leveler Amplifier	197
Line Matching Transformer	111
Loads, Moving	241
Logarithmic Converter	17
Low Frequency:	
Function Generator	73
Oscillators	68-76
Low Pass Filters	186
Low Power Waveguide Terminations	241
Magnetic Tape Systems	11
Magnetometer Probe	107
Meters:	
Ammeters	95, 98, 100, 106-108
Distortion	78-83
Frequency	150, 204
Noise	78-83
Noise Figure	183-185
Ohmmeters	94-95, 98, 103
Power	196, 198-201
Q	12
Ratio	192-193
RX	12
SWR	190-191
Voltmeters	17, 88-101, 103-105
Microvolt-Ammeter	100
Microwave Amplifiers	202-203
Microwave Test Equipment	168-241
Milliammeter, Clip-on DC	106-107

<i>Instrument</i>	<i>Page</i>
Millivoltmeter, RF	96-97
Modulators, AM-FM, Pulse	218
Modulators, FM Stereo	13
Motion Transducer	11
Moving Loads	241
Multi-Hole Couplers	232-233
Narrow Band DC Amplifier	116
Noise:	
Analyzers	78-81
Figure Meter	183-184
Meter	78-83
Sources	185
Null Voltmeter, DC	99-100
Ohmmeters	94-95, 98, 103
Optical Line Follower	17
Optical Tachometer Pickup	151
Optical X-Y Recorder	11
Oscillators:	
Audio and Ultrasonic	68-76
Carrier Test	72
High Quality Audio Tests	74-76
Interpolation and Frequency Measurement	72
Quartz	154-158
Sweep	228-229
Telemeter	72
Transfer	141-143
Wide-Range, Video Tests	76
Oscillator Synchronizers	141, 219
Oscillographs, Multichannel	9-11
Oscilloscopes	28-51
Oscilloscope Camera	53
Oscilloscope Probes	54-55
Oscilloscope Testmobile Cart	54
Panel Covers, Modular Enclosures	18-19
Patch Panel	93
Period Multiplier (for 524 Counter)	139-140
Phase Shifter	240
Phase Unit (for 524 Counter)	139-140
Portable Test Set	93
Power Meters	196, 198-201
Power Meter Calibrator	197
Power Supplies:	
AC	242
General Purpose (dc)	246-256
Klystron	257
Standby	161
Pressure Transducers	11
Printer, Character	17
Printer, Digital	148

<i>Instrument</i>	<i>Page</i>
Probes:	
Broadband	236-237
Current	54, 106-108
Oscilloscope	54-55
Untuned	236-238
Probe Carriages, Universal	236-238
Protector, Dual Crowbar	256
Pulse Generators	58-62
Pushbutton Oscillator	71
Q Comparator	12
Q Meters	12
Quartz Oscillators	154-158
Rack Adapter Frame	18-19
Ratio Meter	192
Reaction Meter (frequency)	204
Recorder, Carrier-type	9
Recorder, Demodulator	9
Recorders, Digital	144-147
Recorder, Optical X-Y	11
Recorders, Strip Chart	17
Recorders, X-Y	16
Recording Systems	9-11
Reflections, Standard	241
Regulated Power Supplies	161, 242, 246-257
Resistive Voltage Divider	109
Resistors, Shunt	109
Rotary Phase Shifters	240
RX Meter	12
Sampling Oscilloscope	46-49
Scanner, Input	14-15
Scanner, Oscilloscope Display	43
SCR DC Power Supplies	254
SHF Test Set	230
Shorting Switch, Waveguide	241
Shorts, Waveguide, Adjustable	241
Shunt Resistors	109
Signal Generators:	
Aircraft Test	13
AM-FM	13
Audio Frequency	74-75
HF	210-211
RF	210-211
SHF	222-225
UHF	214-221
Ultrasonic Frequency	76
VHF	212-213
Signal Generator Calibrators	13
Slide-Screw Tuners	239
Slotted Sections	235-238
Square Wave Generator	57
Stand, Waveguide	179

<i>Instrument</i>	<i>Page</i>
Standard Reflections, Waveguide	241
Standards, Frequency and Time	154-158
Standing Wave Indicator	190-191
Static Inverters	242
Strain Gage Power Module	256
Strip Chart Recorder	17
Sweep Delay Generators, Oscilloscope	37, 42
Sweep Drive	79
Sweep Oscillators	228-229
Switching Time Tester	49
Synchronizers, Oscillator	141, 219
Synthesizer, Frequency	154-155
Systems:	
Data Handling	9-11, 14-15
Frequency Standard	152-153
Tachometer:	
Generator	151
Indicator	150-151
Pickup (optical)	151
Telemeter Oscillator	72
Terminations:	
Coaxial	241
Waveguide	241
Test Leads	111
Testmobile, Oscilloscope	54
Test Oscillators (audio & ultrasonic)	68-76
Test Set:	
Communications Systems	93
Frequency Response	110
H-Band	230
SHF	230
Transistor	13
X-Band	230
Thermistor Mounts	196, 199
Time Comparator	160
Time Interval Counters	126-131, 135-140
Time Interval Units (for <i>hp</i> 524, 5243L, 5245L)	130-131, 139-140
Time Mark Generators, Oscilloscope	37, 43
Transducers	11, 151
Transfer Oscillators	141-143
Transformers:	
Bridging	111
Line Matching	111
Transistor Test Set	13
Translator, Waveform	17
Transport Delay Simulator	16
Traveling-Wave Tube Amplifiers	202-203
Tuners, Coaxial	239
Tuners, Waveguide	239

<i>Instrument</i>	<i>Page</i>
Ultrasonic Signal Generator	76
Universal Bolometer Mount	191
Universal Probe Carriages	236-238
Untuned Probes	236-238
Vacuum Tube Voltmeters	(See Voltmeters)
Variable Attenuators	118, 187-189
Variable Frequency Power Supply	242
VHF Bridge	234
VHF Coaxial Attenuators	189
VHF Detector	234
VHF Vacuum Tube Voltmeter	94-97
Video Amplifiers (for <i>hp</i> 524, 5243L, 5245L)	130-131, 139-140
Video Test Oscillator	76
Viewing Hood, Oscilloscope	55
Voltage Dividers	54-55, 109
Voltage/Frequency Converters	15
Voltmeters:	
AC	88-97
DC	17, 94-95, 98-101, 103-105
Digital	101, 103-105
RF, VHF	94-97
Voltmeter Accessories	109
Warranty	21
Wave Analyzers	78-81
Waveguide:	
Adapters	179
Adjustable Shorts	241
Attenuators	187-188
Broadband Probes	236-238
Clamps	179
Detector Mounts	191, 193
Directional Couplers	232-233
Frequency Meters	204
Loads, Moving	241
Low Pass Filters	186
Noise Sources	185
Phase Shifter	240
Probe Carriages	236-238
Shorting Switch	241
Slotted Sections	236-238
Standard Reflections	241
Stands	179
Terminations	241
Thermistor Mounts	196, 199
Tuners	239
Wideband Amplifiers	113
X-Band Test Set	230
X-Y Recorders	11, 16

INDEX BY INSTRUMENT MODEL NUMBER

<i>Model</i>	<i>Description</i>	<i>Page</i>	<i>Model</i>	<i>Description</i>	<i>Page</i>
A-1	AC-to-DC Converter (Moseley)	17	201C	Audio Oscillator	68, 69
D-1B, D-2	Character Printers (Moseley)	17	202A	Low Frequency Function Generator	73
F-3	Optical Line Follower (Moseley)	17	202C	Low Frequency Oscillator	68, 69
H01-8401	Leveler Amplifier	197	202H,J	FM-AM Signal Generators (Boonton)	13
Q-1,2,3,4	Roll Chart Accessories (Moseley)	16	204B	Transistorized Portable Oscillator	70
2D	X-Y Recorders (Moseley)	16	205AG	Audio Signal Generator	74
2D-5	Transport Delay Simulator (Moseley)	16	206A	Low Distortion Audio Signal Generator	75
2FR	Two-Pen Recorder (Moseley)	16	211A	Aircraft Signal Generator (Boonton)	13
6S	X-Y Recorder/Chart Advance (Moseley)	16	211A	Square Wave Generator	57
7	X-Y Recorder (Moseley)	16	212A	Pulse Generator	58
7	DC Differential Transformer (Sanborn)	11	213B	Pulse Generator	61
22	DC Voltmeter (Moseley)	17	214A	Pulse Generator	59
24	Waveguide Stand	179	215A	Pulse Generator	60, 61
25 Series	Waveguide Clamps	179	218AR	Digital Delay Generator	62
40 Series	Keyboards (Moseley)	17	219A	FM Stereo Modulator (Boonton)	13
60D	Logarithmic Converter (Moseley)	17	219A	Dual Trigger Unit	62
83	Strip-Chart Recorder (Moseley)	17	219B	Dual Pulse Unit	62
100E	Frequency Standard	156	219C	Digital Pulse Duration Unit	62
101	Waveform Translator (Moseley)	17	225A	FM-AM Signal Generator (Boonton)	13
101A	1 MC Oscillator	156	230A	Signal Generator Power Amplifier (Boonton)	13
103AR, 104AR	Quartz Oscillators	157	232A	Glide Slope Signal Generator (Boonton)	13
107AR,BR	Quartz Oscillators	158	233A	Carrier Test Oscillator	72
114BR	Time Comparator	160	235A	Navigation Aid Test Set (Boonton)	13
115BR,CR	Frequency Dividers and Clocks	159	240A	Sweep Signal Generator (Boonton)	13
120B	450 KC Oscilloscope	28	241A	Pushbutton Oscillator	71
122A	Dual Trace 200 KC Oscilloscope	29	245C,D	Signal Generator Calibrators (Boonton)	13
130C	200 μ v/cm Oscilloscope	30, 31	250A	RX Meter (Boonton)	12
135,136	X-Y Recorders (Moseley)	16	260A	Q Meter (Boonton)	12
140A	Oscilloscope	32, 33	265A	Q Comparator (Boonton)	12
150 Series	Recording Systems (Sanborn)	10	267	Pressure Transducers (Sanborn)	11
160B	15 MC Oscilloscope	36, 37	275A	Transistor Test Set (Boonton)	12
162A,B	Scope Dual Channel Amplifiers	36, 37	280A	Q Meter (Boonton)	12
162D	Scope High Gain Vertical Amplifier	37	281A	Waveguide-to-Coaxial Adapters	179
162F	Scope Fast Rise Preamplifier	37	290A	Waveguide Cover-to-Choke Flange	179
166A	Scope Auxiliary Plug-In	37	292A,B	Waveguide-to-Waveguide Adapters	179
166B	Scope Marker Generator	37	296,297	Portable Recorders (Sanborn)	9
166D	Scope Sweep Delay Generator	37	297A	Sweep Drive	79
170A	30 MC Oscilloscope	36, 37	299	DC Recorder (Sanborn)	9
175A	50 MC Oscilloscope	38 - 43	301	Carrier-Type Recorder (Sanborn)	9
185B	1000 MC Oscilloscope	46 - 51	302	Demodulator Recorder (Sanborn)	9
186A	Switching Time Tester	48, 49	302A	Wave Analyzer	78, 79
187B	Scope Dual Trace Amplifier	48	310A	Wave Analyzer	80, 81
190A	Q Meter (Boonton)	12	320	DC System (Sanborn)	9
196A,B	Oscilloscope Cameras	53	321	Carrier System (Sanborn)	9
200AB	Audio Oscillator	68, 69	322	AC or DC System (Sanborn)	9
200CD	Wide Range Oscillator	68, 69	330B,C,D	Noise and Distortion Analyzers	82, 83
200D	Power Supply (Harrison)	255	340B	Noise Figure Meter	184, 185
200J	Interpolation Oscillator	72	342A	Noise Figure Meter	184, 185
200SR	Wide Range Oscillator	110	343A	VHF Noise Source	185
200T	Precision Telemeter Test Oscillator	72	344A	Noise Figure Meter	183

<i>Model</i>	<i>Description</i>	<i>Page</i>	<i>Model</i>	<i>Description</i>	<i>Page</i>
345B	IF Noise Source	185	477B	Coaxial Thermistor Mount	196
347A	Waveguide Noise Source	185	478A	Coaxial Thermistor Mount	199
349A	UHF Noise Source	185	485A,B	Waveguide Detector Mounts	191
350 Series	Recorder Systems (Sanborn)	10	485D	Reflectometer Detectors	193
350C,D	Attenuators, 500 and 600 Ohm	118	486A	Waveguide Thermistor Mount	199
353A	Patch Panel	93	487B,C	Waveguide Thermistor Mounts	196
355C,D	VHF Coaxial Attenuators	189	489A-495A	Traveling-Wave Tube Amplifiers	202, 203
360, 361	Event Recorders (Sanborn)	11	500B,C	Electronic Frequency Meters	150
360 Series	Low Pass Filters	186	505A	SCR Power Supply (Harrison)	254
362A	Low Pass Filter	186	506A	Optical Tachometer Pickup	151
370 Series	Waveguide Attenuators, Fixed	187	508	Tachometer Generators	151
372	Precision Fixed Waveguide Attenuator	187	510A	SCR Power Supply (Harrison)	254
375A	Waveguide Variable Flap Attenuator	187	520A	SCR Power Supply (Harrison)	254
382A,B,C	Precision Variable Waveguide Attenuators	188	521	Industrial Electronic Counters	134
393A	Variable Coaxial Attenuator	189	522B	Electronic Counter	135
394A	Variable Coaxial Attenuator	189	523	Electronic Counters	136, 137
400D	Vacuum Tube Voltmeter	88, 89	524	Electronic Counters	138 - 140
400H	Vacuum Tube Voltmeter	88, 89	525A,B,C	Frequency Converter Units	139, 140
400L	Logarithmic Vacuum Tube Voltmeter	88, 89	526A	Video Amplifier Unit	139, 140
403A,B	Transistorized AC Voltmeters	92	526B	Time Interval Unit	139, 140
405A-95C	Adapter	101	526C	Period Multiplier	139, 140
405BR,CR	Digital DC Voltmeters	101	526D	Phase Unit	139, 140
410B	High Frequency VTVM	94	532 Series	Waveguide Frequency Meters	204
410C	Electronic Voltmeter	95	536A	Coaxial Wavemeter	204
411A	RF Millivoltmeter	96, 97	540B	Transfer Oscillator	142, 143
412A	DC Voltmeter-Ohmmeter-Ammeter	98	560A	Digital Recorder	144, 145
413A	DC Null Voltmeter	99	561B	Digital Recorder	144, 145
415B,D	Standing Wave Indicators	190, 191	562A	Digital Recorder	146, 147
416B	Ratio Meter	192	565A	Digital Printer	148
417A	VHF Detector	234	570A	Digital Clock	148
420A,B	Wide Band Crystal Detectors	193	571B	Digital Clock	148
421A	Waveguide Crystal Detector Mounts	193	580A	Digital-to-Analog Converter	149
422A	Crystal Detectors	193	581	Displacement Probe (Sanborn)	11
425A	DC Microvolt-Ammeter	100	581A	Digital-to-Analog Converter	149
428A,B	Clip-On DC Milliammeters	106, 107	606A	High Frequency Signal Generator	210, 211
430C	Microwave Power Meter	196	608C,D	VHF Signal Generators	212, 213
431B	Power Meter	198, 199	612A	UHF Signal Generator	214, 215
434A	Calorimetric Power Meter	200, 201	614A	UHF Signal Generator	220, 221
440A	Detector Mount	236, 237	616B	UHF Signal Generator	220, 221
442B	Broadband Probe	236	618B	SHF Signal Generator	222, 223
444A	Broadband Probe, Untuned	236, 237	620A	SHF Signal Generator	222, 223
446B	Untuned Probe	238	623B	SHF Test Set (Dymec)	230
450A	Stabilized Laboratory Amplifier	112	624C	X-Band Test Set (Dymec)	230
456A	AC Current Probe	108	626A	SHF Signal Generator	224, 225
457A	AC-to-DC Converter	102	628A	SHF Signal Generator	224, 225
460AR,BR	Wide Band Amplifiers	113	650 Series	DC to 5 KC Optical System (Sanborn)	11
466A	AC Amplifier	112	650A	Test Oscillator	76
476A	Bolometer Mount, Untuned	191	670B	Optical X-Y Recorder (Sanborn)	11
			680 Series	Strip-Chart Recorders (Moseley)	17
			682C-687C	Electronic Sweep Oscillators	228, 229
			711A	Laboratory Power Supply	255
			712B	Regulated Power Supply	255

<i>Model</i>	<i>Description</i>	<i>Page</i>	<i>Model</i>	<i>Description</i>	<i>Page</i>
715A	Klystron Power Supply	257	932A	Harmonic Mixer, Waveguide	143
716A	Klystron Power Supply	257	934A	Harmonic Mixer, Coaxial	143
721A	Transistor Power Supply	249	938A	Frequency Doubler Set	226, 227
723A	Power Supply	249	940A	Frequency Doubler Set	226, 227
724BR	Standby Power Supply	161	950 Series	Recording Systems (Sanborn)	10
725AR	Standby Power Supply	161	1051A,		
726AR	Power Supply	252	1052A	Combining Cases	18, 19
738AR	Voltmeter Calibrator	110	1100A	Delay Line	51
739AR	Frequency Response Test Set	110	1102A	Accessory Kit	50, 51
750	Waveguide Cross-Guide Couplers	232, 233	1110A	Current Probe	54
752	Waveguide Directional Couplers	232, 233	1111A	AC Current Amplifier	54
774D-777D	Coaxial Dual Directional Couplers	232, 233	1115A,		
800A-2	Power Supply (Harrison)	249	1116A	Testmobiles	54
800B-2	Power Supply (Harrison)	249	1400A	Scope Differential Amplifier	32, 33
801C	Strain Gage Power Module (Harrison)	256	1401A	Scope Dual Trace Amplifier	32, 33
802B	Transistorized Power Supply (Harrison)	252	1420A	Scope Time Base	32, 33
803A	VHF Bridge	234	1750A	Scope Dual Trace Vertical Amplifier	40
805C,D	Coaxial Slotted Sections	235	1751A	Scope Fast-Rise Vertical Amplifier	40, 41
806B	Coaxial Slotted Section	236, 237	1752A	Scope High Gain Vertical Amplifier	40, 41
808A	Power Supply (Harrison)	250	1754A	Scope Four-Channel Vertical Amplifier	41
809A	Power Supply (Harrison)	250	1780A	Scope Auxiliary Plug-In	42
809B	Universal Probe Carriage	236, 237	1781B	Scope Sweep Delay Generator	42
810A,B	Waveguide Slotted Sections	236, 237	1782A	Scope Display Scanner	42, 43
810B	Power Supply (Harrison)	251	1783A	Scope Time Mark Generator	43
812C	High Current Supplies (Harrison)	252	2000 Series	Magnetic Tape System (Sanborn)	11
814A	Power Supply (Harrison)	251	2010A-F	Data Acquisition Systems (Dymec)	14
814B	Universal Probe Carriage	238	2040A	Frequency Measuring System (Dymec)	141
815B	Waveguide Slotted Sections	238	2210	Voltage-to-Frequency Converter (Dymec)	15
850 Series	Recording Systems (Sanborn)	10	2211	Voltage-to-Frequency Converter (Dymec)	15
855B	DC Power Supply (Harrison)	246, 247	2401A	Integrating Digital Voltmeter (Dymec)	103
860-4000	FIFO Amplifier (Sanborn)	114	2410A	AC/Ohms Converter (Dymec)	103
860-4200	Wideband Amplifier (Sanborn)	115	2411A	Guarded Data Amplifier (Dymec)	103
860-4300	Narrow Band Amplifier (Sanborn)	116	2460A	DC Amplifier (Dymec)	117
865B	DC Power Supply (Harrison)	246, 247	2461A	M1-M4 Amplifier Plug-Ins (Dymec)	117
870A	Waveguide Tuners, Slide Screw	239	2508A	Digital Clock (Dymec)	15
872A	Coaxial Slide Screw Tuner	239	2526	Coupler (Dymec)	15
880	Low Voltage Power Supply (Harrison)	249	2530	Binary/Decimal Register (Dymec)	15
880A,B	Waveguide Tuners, E-H	239	2532A	Digital Comparator (Dymec)	15
881A	Power Supply (Harrison)	250	2540	Coupler (Dymec)	15
885A	Waveguide Phase Shifters	240	2545	High Speed Tape Punch Set (Dymec)	15
890A	Power Supply (Harrison)	255	2590A	Microwave Frequency Converter	141
895A, 896A	Power Supplies (Harrison)	255	2650A	Oscillator Synchronizer (Dymec)	219
906A	Sliding Coaxial Termination	241	2900 Series	Input Scanners (Dymec)	14, 15
908A	Coaxial Termination	50, 51; 241	2911	Guarded Cross-Bar Scanner (Dymec)	15
910A,B	Waveguide Terminations, Low Power	241	3400A	RMS Voltmeter	90, 91
912A	Waveguide Termination, High Power	241	3440A	Digital Voltmeter	104, 105
913A	Waveguide Termination, High Power	241	3441A,		
914A,B	Waveguide Moving Loads	241	3442A	Plugs-Ins for 3440A	104, 105
916	Waveguide Standard Reflections	241	3528A	Current Probe	107
920A,B	Waveguide Adjustable Shorts	241			
930A	Waveguide Shorting Switch	241			

<i>Model</i>	<i>Description</i>	<i>Page</i>	<i>Model</i>	<i>Description</i>	<i>Page</i>
3529A	Magnetometer Probe	107	10121A	Sync Cable	51
3550A	Portable Test Set	93	10122A	Type N-to-BNC Cable	50
4011A, 4012A	Static Inverters	242	10175A,B	Viewing Hoods	55
4301A	Variable Frequency Power Supply	242	10200B	Sync Probe	47
5060 Series	Cabinet Components	18, 19	10201A	5:1 Resistive Divider	50
5100A, 5110A	Frequency Synthesizer	154, 155	10201B	10:1 Resistive Divider	50
5207-1	Voltage-to-Frequency Converter (Dymec)	15	10201C	50:1 Resistive Divider	50
5211A,B	Electronic Counters	124, 125	10201D	100:1 Resistive Divider	50
5212A	Electronic Counter	124, 125	10202B	10:1 Divider	50, 51
5214L	Preset Counter	132, 133	10203A	100:1 Divider	51
5232A	Electronic Counter	124, 125	10204B	50-ohm Tee	50, 51
5233L	Electronic Counter	126, 127	10205A	Sync Take-Off	51
5242L- 5245L	Electronic Counters	128, 129	10208A	Blocking Capacitor	50, 51
5251A- 5262A	Plugs-Ins for 5243L and 5245L Counters	130, 131	10209A	Blocking Capacitor	50, 51
5275A	Time Interval Counter	131	10210A	Probe Socket	51
5512A	Electronic Counter	124, 125	10212A	Delay Line Load	51
5532A	Electronic Counter	124, 125	10225A	Universal Adapters	49
5636	H-Band Test Set (Dymec)	230	10227A	Extender Cable	49
5796	Transfer Oscillator Synchronizer (Dymec)	141	10350A	Scope Camera Adapter	53
6204A	Dual Range Power Supply (Harrison)	248	10351A	Scope Camera Case	53
6206A	Dual Range Power Supply (Harrison)	248	10400B, 10401A	Plug-In Extenders	55
6224A	DC Power Supply (Harrison)	246, 247	10402A	Time Axis Extension Cable	55
6226A	DC Power Supply (Harrison)	246, 247	10403A	Alignment Attenuator	55
6242	Digital Data Plotting System (Dymec)	14	10404A	Vertical Test Adapter	55
6242A	Power Supply (Harrison)	251	10405A	Vertical Response Tester	55
6244A	Power Supply (Harrison)	251	10501A- 10503A	Cable Assemblies	111
6343A- 6348A	Modular Plug-In Power Supplies (Harrison)	253	11000A- 11003A	Cable Assemblies	111
6455A	SCR Power Supply (Harrison)	254	11004A, 11005A	Transformers	111
6575	Digital Magnetic Tape Plotting System (Dymec)	14	11006A- 11019A	Wide Band Amplifier Accessories	113
6910A	Dual Protector (Harrison)	256	11018A	Adapter for 410B VTVM	109
6920A	Meter Calibrator (Harrison)	256	11019A	Adapter	113
H01-8401	Leveler Amplifier	197	11022A- 11027A	Probe Tips	97
8402A	Power Meter Calibrator	197	11028A	Current Divider	108
8614A, 8616A	UHF Signal Generators	216, 217	11029A- 11034A	Shunt Resistors	109
8714A, 8716A	Modulators	218	11035A	Cable Assembly	111
10001A- 10003B	Voltage Divider Probes	55	11036A	AC Probe	95
10010C	BNC Probe Tip	55	11039A- 11041A	Capacitive Voltage Dividers	109
10025A	General Purpose Probe	55	11042A	Probe Coaxial Tee Connector	109
10035A	Voltage Divider Probe Tips (kit)	55	11043A	Probe Coaxial "N" Connector	109
10100B	Feed Through Termination	54	11044A	DC Resistive Divider	109
10110A, 10111A	Adapters (BNC-to-Banana)	54, 55; 111	11500A, 11501A	Cable Assemblies	111
			11507A	Output Termination	211
			11508A	Terminated Output Cable	213
			11509A	Fuseholder	213

Sales and Service Representatives in North America

HEWLETT-PACKARD COMPANY
 1501 Page Mill Road
 Palo Alto, Calif.
 Telephone (415) 326-7000
 TWX: 415-492-9200
 Cable: HEWPAK

+ Rochester 28, New York
 Syracuse Sales Division
 Hewlett-Packard Company
 800 Linden Avenue
 (716) 381-4120

+ Syracuse 11, New York
 Syracuse Sales Division
 Hewlett-Packard Company
 Pickard Bldg.
 East Molloy Road
 (315) 464-2486

+ Rochester 28, New York
 Syracuse Sales Division
 Hewlett-Packard Company
 82 Washington St.
 (914) 454-7330

+ BOSTON AREA
 Burlington, Massachusetts
 Yawell Associates, Inc.
 Middlesex Turnpike
 (617) 277-9000

+ Middletown 8, Connecticut
 Yawell Associates, Inc.
 589 Saybrook Rd.
 (203) 546-4611

+ New York 21, New York
 RMC Sales Division
 Hewlett-Packard Company
 236 East 75th Street
 (212) 879-2023

Englewood, New Jersey
 RMC Sales Division
 Hewlett-Packard Company
 391 Grand Avenue
 (201) 567-3933

Asbury Park, New Jersey
 Robinson Sales Division
 Hewlett-Packard Company
 1317 Railroad Avenue
 (201) 531-3160

+ PHILADELPHIA AREA
 West Conshohocken, Pennsylvania
 Robinson Sales Division
 Hewlett-Packard Company
 144 Elizabeth Street
 (215) 248-1600 and 828-6200

Richmond 30, Virginia
 Bivins & Caldwell, Inc.
 1219 High Point Ave.
 (703) 365-7931

+ WASHINGTON, D. C. AREA
 Rockville, Maryland
 Horman Associates, Inc.
 941 Rollins Avenue
 (301) 427-7560

+ Montreal, Quebec
 Hewlett-Packard (Canada)
 8270 Mayfield Street
 (514) 735-2275

+ Detroit 35, Michigan
 Crossley Associates, Inc.
 14425 West Eight Mile Road
 (313) 342-5700

+ Cleveland 24, Ohio
 Crossley Associates, Inc.
 (Call Detroit office collect
 to obtain local address)

+ Indianapolis 5, Indiana
 Crossley Associates, Inc.
 3915 Meadows Dr.
 (317) 544-4991

+ Dayton 9, Ohio
 Crossley Associates, Inc.
 1250 W. Dorothy Lane
 (513) 299-3594

+ Pittsburgh 27, Pennsylvania
 Crossley Associates, Inc.
 (Call Detroit office collect
 to obtain local address)

Camp Hill, Pennsylvania
 Robinson Sales Division
 Hewlett-Packard Company
 Park Plaza Office Bldg.
 (717) 737-6791

Baltimore 15, Maryland
 Horman Associates, Inc.
 3006 West Cold Spring Lane
 (301) 664-4400

+ Seattle 9, Washington
 ARVA, Inc.
 1326 Prospect Street
 (206) 622-0177

+ Denver 10, Colorado
 Labana & Company
 1884 South Broadway
 (303) 733-3791

+ St. Paul 14, Minnesota
 Crossley Associates, Inc.
 942 Raymond Avenue
 (612) 644-7881

Toronto, Ontario
 Hewlett-Packard (Canada) Ltd.
 1415 Lawrence Avenue W.
 (416) 249-5195

Ottawa, Ontario
 Hewlett-Packard (Canada) Ltd.
 1762 Carling Avenue
 (613) 727-8162

Portland 1, Oregon
 ARVA, Inc.
 2035 S. W. 50th Ave.
 (503) 222-7337

Boylston City 15, Utah
 Labana & Co.
 482 Major St.
 (801) 464-0166

Sacramento 14, California
 Neely Enterprises
 1317-1338 Street
 (914) 442-8901

△ SAN FRANCISCO AREA
 Neely Enterprises
 501 Laurel Street
 San Carlos, California
 (415) 591-7461

+ LOS ANGELES AREA
 Neely Enterprises
 3929 Lankershim Blvd.
 North Hollywood, Calif.
 (818) 197-1282 and 746-3811

+ San Diego 6, California
 Neely Enterprises
 1055 Shafter Street
 (714) 233-8103

+ Scottsdale, Arizona
 Neely Enterprises
 3909 No. Scottsdale Rd.
 (602) 946-7401

Tucson, Arizona
 Neely Enterprises
 232 So. Tucson Blvd.
 (602) 623-2544

Los Cruces, New Mexico
 Neely Enterprises
 114 S. Water Street
 (505) 524-2486

+ Albuquerque, New Mexico
 Neely Enterprises
 6501 Lomas Blvd., N. E.
 (505) 266-5586

+ Dallas 19, Texas
 Earl Lipscomb Associates
 P. O. Box 7084
 3605 Inwood Road
 (214) 357-1881 and 392-6447

+ Houston 5, Texas
 Earl Lipscomb Associates
 P. O. Box 6644
 3825 Richmond Ave.
 (713) 447-2407

Montgomery, Alabama
 Bivins & Caldwell, Inc.
 Holiday Office Center
 Suite No. 9
 (205) 881-4591

+ Orlando, Florida
 Sales Division
 Hewlett-Packard Company
 621 Commonwealth Ave.
 (305) 426-5541

St. Petersburg 8, Florida
 Sales Division
 Hewlett-Packard Company
 410-180th Ave., Madeira Beach
 (813) 391-0211

+ Chicago 45, Illinois
 Crossley Associates
 2501 West Peterson St.
 (312) 275-1600

+ St. Louis 17, Missouri
 Harris-Hanson Company
 2818 South Brentwood Blvd.
 (314) 647-0350

+ High Point, North Carolina
 Bivins & Caldwell, Inc.
 1923 N. Main Street
 (919) 862-6873

Kansas City 32, Missouri
 Harris-Hanson Company
 7916 Paroo Street
 (816) 444-9444

+ Atlanta 5, Georgia
 Bivins & Caldwell, Inc.
 3710 Maple Drive, N. E.
 (404) 233-7141

△ For replacement parts and repair services in the San Francisco area, please contact Hewlett-Packard Company at: 395 Page Mill Road, Palo Alto, California, (415) 326-3950.

+ indicates Instrument Repair Stations

Authorized Sales and Service Offices in Western Europe

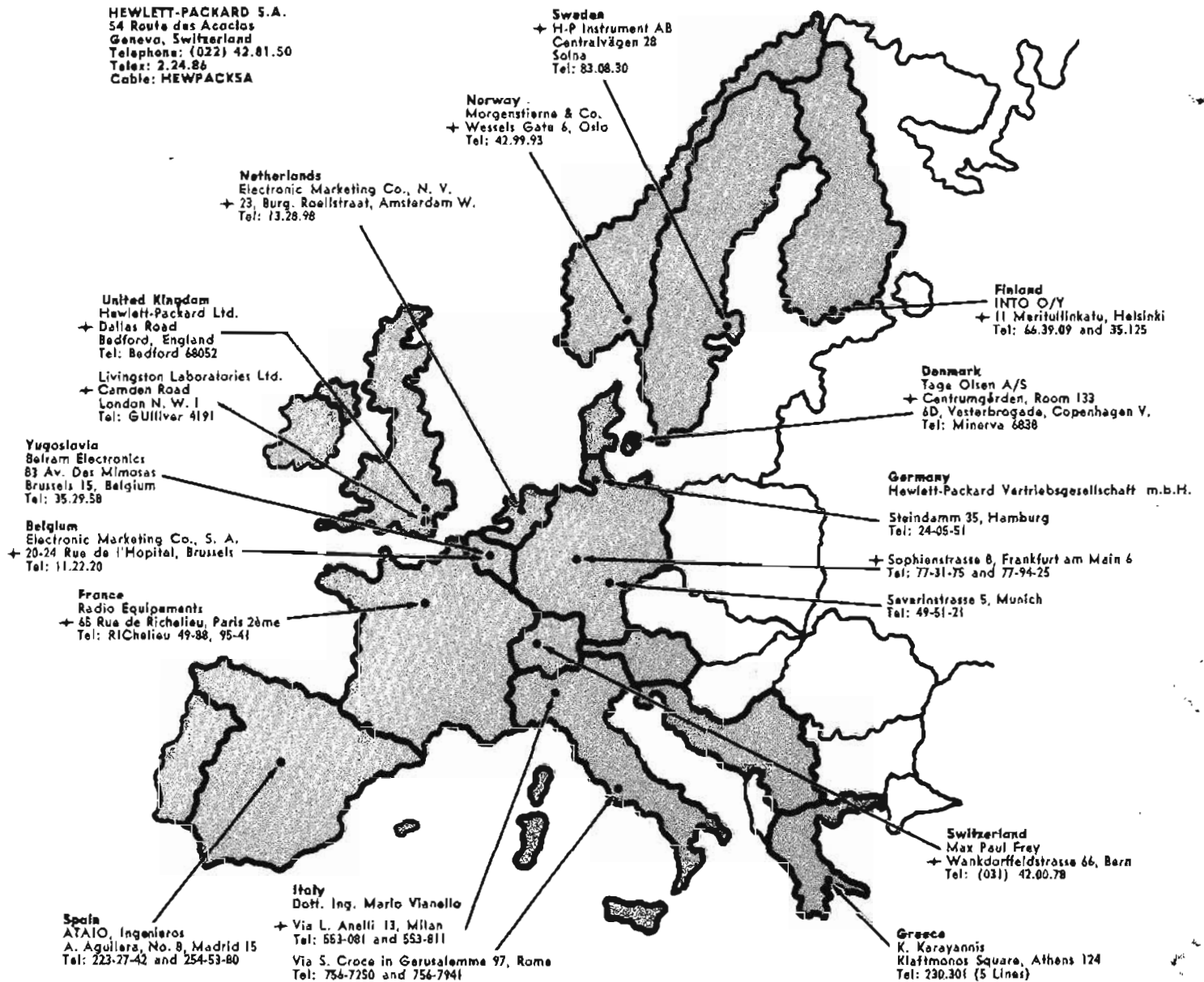

Authorized Sales and Service Offices In Other Areas

Argentina
Mauricio A. Suarez
Telecomunicaciones
Carlos Calvo 224, Buenos Aires
Tel: 30-6312

Australia
Sample Electronics Pty. Ltd.
→ 9-11 Cremorne Street
Richmond E. I, Victoria
Tel: 42-4757 (3 lines)

48 Chippen Street, Sydney
New South Wales
Tel: 69-6338 (6 lines)

India
The Scientific Instrument Company, Ltd.
6, Tej Bahadur Sapru Road, Allahabad 1
Tel: 2451

240, Dr. Dadabhai Naoroll Road,
Bombay 1
Tel: 26-2642

11, Esplanade East, Calcutta 1

30, Mount Road, Madras 2

B-7, Almeri Gate Extn., New Delhi 1
Tel: 26053

Iran
Telecom Ltd.
P. O. Box 1012, Tehran
Tel: 43850

Israel
Electronics & Engineering Ltd.
16 Kramenski St., Tel Aviv
Tel: 35021 (3 lines)

Japan
Seki & Company, Ltd.

→ Chushoku Building
9 2-chome, Nihonbashi Koami-cho
Chuo-ku, Tokyo
Tel: (860) 4121-5

Sumi Bldg., 106 Umegae-cho
Kita-ku, Osaka
Tel: (362) 8151-5

Korea
American Trading Company, Korea, Ltd.
Song Bo Building
112-35 Sakong-Dang, Seoul
Tel: 3-7049, 3-7613

New Zealand
Geo. H. Sample & Son (N. Z.) Ltd.
431 Mount Albert Road
Mount Roskill, Auckland, 53
Tel: 898-439

South Africa
F. H. Flanzer & Co. (Pty.), Ltd.
Rosella House
Buitencingle Street, Cape Town
Tel: 3-3817

Taiwan (Formosa)
Hwa Shang Electronic Co., Ltd.
21 Nanking West Road, Taipei
Tel: 4-6076, 4-5936

FOR SALES AND SERVICE ASSISTANCE IN AREAS NOT LISTED CONTACT:

International Marketing Department
Hewlett-Packard Company
1501 Page Mill Road
Palo Alto, California, U.S.A.
Telephone: (415) 326-7000
TWX: 415-492-9200
Telex: 033811
Cable: HEWPACK